

3-Channel, 2.3W, Filterless Class D Amplifiers with Active Crossover

General Description

The MAX9706/MAX9707 combine three high-efficiency Class D amplifiers with an active crossover to provide stereo highpass outputs, and a mono lowpass output. All three channels deliver up to 2.3W at 1% THD+N per channel into 4Ω when operating from a 5V supply.

An internal active filter processes the stereo inputs (left and right) into stereo highpass and mono lowpass outputs. The crossover frequency is pin-selectable to four different frequencies to accommodate a variety of speaker configurations. The internal Class D amplifiers feature low-EMI, spread-spectrum outputs. No output filters are required.

The MAX9706 features Maxim's DirectDrive™ headphone amplifier, providing ground-referenced headphone outputs without the need for bulky DC-coupling capacitors. The headphone outputs are capable of delivering 95mW per channel into 16Ω from a 3.3V supply, and are protected against ESD up to ±8kV.

The MAX9706/MAX9707 feature pin-programmable gain, synchronization inputs and outputs, and a shutdown mode that reduces supply current to less than 1μA. All amplifiers feature click-and-pop suppression circuitry. Both devices are fully specified over the -40°C to +85°C extended temperature range and are available in the thermally enhanced 36-pin (6mm x 6mm x 0.8mm) thin QFN package.

Applications

Notebook Audio Solutions	Multimedia Monitors
2.1 Speaker Solutions	Portable DVD Players
Desktop PCs	Table-Top LCD TVs

Features

- ◆ Triple Class D Amplifiers Deliver 3 x 2.3W into 4Ω
- ◆ Internal Active Crossover Filter with Adjustable Crossover Frequency
- ◆ Low-EMI, Spread-Spectrum Modulation
- ◆ Low 0.02% THD+N
- ◆ High PSRR (71dB)
- ◆ DirectDrive Headphone Amplifier (MAX9706)
- ◆ Enhanced Click-and-Pop Suppression
- ◆ Input and Output Modulator Synchronization
- ◆ Low-Power Shutdown Mode
- ◆ Up To 90% Efficiency
- ◆ Space-Saving (6mm x 6mm x 0.8mm) 36-Pin Thin QFN Package

Ordering Information

PART	HP AMP	PIN-PACKAGE	PKG CODE
MAX9706ETX+	Yes	36 Thin QFN	T3666N-1
MAX9707ETX+	No	36 Thin QFN	T3666N-1

+Denotes lead-free package.

Note: These devices operate over the -40°C to +85°C temperature range.

Functional Diagrams and Pin Configurations appear at end of data sheet.

Block Diagram

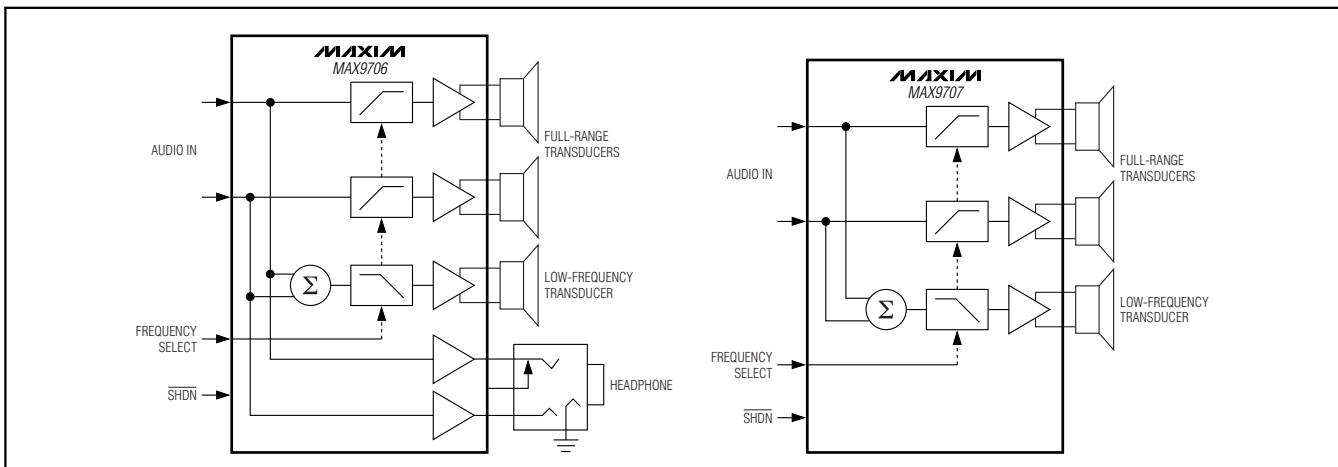

3-Channel, 2.3W, Filterless Class D Amplifiers with Active Crossover

ABSOLUTE MAXIMUM RATINGS

V_{DD}, PV_{DD}, HPV_{DD}, CPV_{DD} to GND-0.3V to +6V
 GND to PGND, CPGND-0.3V to +0.3V
 CPV_{SS}, V_{SS} to GND-6V to +0.3V
 C1N to GND(CPV_{SS} - 0.3V) to +0.3V
 C1P to GND-0.3V to (CPV_{DD} + 0.3V)
 HPL, HPR-3V to +3V
 All Other Pins to GND-0.3V to (V_{DD} + 0.3V)
 OUT₊, OUT₋, Short Circuit to GND or PV_{DD}Continuous
 OUT₊ Short Circuit to OUT₋Continuous
 HPR, HPL Short Circuit to GNDContinuous
 MONO_OUT Short Circuit to GND or V_{DD}Continuous
 Continuous Current (PV_{DD}, OUT₊, OUT₋, PGND)1.7A

Continuous Current (MONO_OUT, CPV_{DD}, C1N, C1P, CPGND, CPV_{SS}, V_{SS}, HPV_{DD}, HPR, HPL)0.85A
 Continuous Current (all other pins)20mA
 Continuous Power Dissipation (T_A = +70°C)
 Single-Layer Board
 36-Pin TQFN (derate 26.3mW/°C above +70°C)2105mW
 Multilayer Board
 36-Pin TQFN (derate 35.7mW/°C above +70°C)2857mW
 Operating Temperature Range-40°C to +85°C
 Storage Temperature Range-65°C to +150°C
 Junction Temperature+150°C
 Lead Temperature (soldering, 10s)+300°C

Stresses beyond those listed under "Absolute Maximum Ratings" may cause permanent damage to the device. These are stress ratings only, and functional operation of the device at these or any other conditions beyond those indicated in the operational sections of the specifications is not implied. Exposure to absolute maximum rating conditions for extended periods may affect device reliability.

ELECTRICAL CHARACTERISTICS

(V_{DD} = PV_{DD} = HPV_{DD} = 5V, GND = PGND = CPGND = 0V, $\overline{\text{SHDN}}$ = V_{DD}, GAIN1 = GAIN2 = GND (SPKR = +9dB, HP = 0dB), HPS = GND, FS0 = FS1 = GND (800Hz), MGAIN = float (-6dB), SYNC_IN = V_{DD} (SSM), speaker load R_L connected between OUT₊ and OUT₋, unless otherwise noted, R_L = ∞. Headphone load R_{LH} connected between HPR/HPL to GND, R_{LH} = ∞. C_{BIAS} = 1μF to GND, C1 = 1μF, C2 = 1μF. T_A = T_{MIN} to T_{MAX}, unless otherwise noted. Typical values at T_A = +25°C.) (Note 1)

PARAMETER	SYMBOL	CONDITIONS	MIN	TYP	MAX	UNITS	
Speaker Amplifier Supply Voltage Range	V _{DD} , PV _{DD}	Inferred from PSRR test	4.5		5.5	V	
Headphone Amplifier Supply Voltage Range	HPV _{DD} , CPV _{DD}	Inferred from PSRR test (MAX9706)	3.0		5.5	V	
Quiescent Supply Current	I _{DD}	Speaker mode		25	35	mA	
		Headphone mode, HPS = V _{DD} (MAX9706)		7	12		
Shutdown Supply Current	I _{SHDN}	$\overline{\text{SHDN}}$ = GND		0.5	3	μA	
Input Resistance	R _{IN}		15	25	35	kΩ	
Turn-On Time, Shutdown to Full Operation		Speaker mode		87		ms	
		Headphone mode (MAX9706)		87			
SPEAKER AMPLIFIERS (OUTL₋, OUTR₋, OUTM₋)							
Output Power (Note 2)	P _{OUT}	R _L = 8Ω, THD+N = 1%		1.4		W	
		R _L = 4Ω, THD+N = 1%		2.3			
Total Harmonic Distortion Plus Noise	THD+N	P _{OUT} = 1W, bandwidth = 22Hz to 22kHz (Note 2)	R _L = 8Ω		0.06	%	
			R _L = 4Ω		0.07		
Signal-to-Noise Ratio	SNR	R _L = 8Ω, P _{OUT} = 1W (Note 2)	Bandwidth = 22Hz to 22kHz		87	dB	
			A-weighted		92		
Power-Supply Rejection Ratio	PSRR	V _{DD} = PV _{DD} = 4.5V to 5.5V, T _A = +25°C		50	71	dB	
		100mV _{p-p} ripple (Note 3)	f = 2kHz, OUTL ₋ , OUTR ₋		51		
			f = 100Hz, OUTM ₋		65		

3-Channel, 2.3W, Filterless Class D Amplifiers with Active Crossover

MAX9706/MAX9707

ELECTRICAL CHARACTERISTICS (continued)

($V_{DD} = PV_{DD} = HPV_{DD} = 5V$, $GND = PGND = CPGND = 0V$, $\overline{SHDN} = V_{DD}$, $GAIN1 = GAIN2 = GND$ (SPKR = +9dB, HP = 0dB), HPS = GND, FS0 = FS1 = GND (800Hz), MGAIN = float (-6dB), SYNC_IN = V_{DD} (SSM), speaker load R_L connected between OUT_+ and OUT_-, unless otherwise noted, $R_L = \infty$. Headphone load R_{LH} connected between HPR/HPL to GND, $R_{LH} = \infty$. $C_{BIAS} = 1\mu F$ to GND, $C1 = 1\mu F$, $C2 = 1\mu F$. $T_A = T_{MIN}$ to T_{MAX} , unless otherwise noted. Typical values at $T_A = +25^\circ C$.) (Note 1)

PARAMETER	SYMBOL	CONDITIONS		MIN	TYP	MAX	UNITS
Speaker Path Gain (Note 4)		GAIN2 = 0	GAIN1 = 0		9		dB
		GAIN2 = 0	GAIN1 = 1		10.5		
		GAIN2 = 1	GAIN1 = 0		12		
		GAIN2 = 1	GAIN1 = 1		13.5		
Channel-to-Channel Gain Tracking					0.3		%
MONO Gain Offset (Note 5)		MGAIN = GND			-4.5		dB
		MGAIN = float			-6		
		MGAIN = V_{DD}			-7.5		
Crosstalk		Right to left, left to right, $f_{IN} = 10kHz$, $P_{OUT} = 1W$			70		dB
Maximum Capacitive Load	C_L	No sustained oscillations			200		pF
Efficiency	η	$R_L = 8\Omega$, $P_{OUT} = 3 \times 1W$, $f = 800Hz$			90		%
		$R_L = 4\Omega$, $P_{OUT} = 3 \times 1W$, $f = 800Hz$			88		
Class D Center Frequency	f_{OSC}	FFM, SYNC_IN = GND		955	1100	1270	kHz
		FFM, SYNC_IN = float		1140	1340	1540	
		SSM, SYNC_IN = V_{DD}			1150		
Class D Spreading Bandwidth		SSM mode, SYNC_IN = V_{DD}			± 50		kHz
SYNC_IN Frequency Lock Range				1000		1500	kHz
Output Offset Voltage	V_{OS}	OUT_+ to OUT_-			14		mV
Click-and-Pop Level	K_{CP}	Peak voltage, A-weighted, 32 samples per second (Note 6)		Into shutdown	47		dBV
				Out of shutdown	50		
CROSSOVER FILTERS							
Cutoff Frequency Accuracy		(Note 7)				± 15	%
Crossover Frequency	f_{XO}	FS0 = 0	FS1 = 0		800		Hz
		FS0 = 0	FS1 = 1		1066.7		
		FS0 = 1	FS1 = 0		1600		
		FS0 = 1	FS1 = 1		2133.3		
Left-to-Right Cutoff Frequency Tracking					± 0.5		%

3-Channel, 2.3W, Filterless Class D Amplifiers with Active Crossover

ELECTRICAL CHARACTERISTICS (continued)

($V_{DD} = PV_{DD} = HPV_{DD} = 5V$, $GND = PGND = CPGND = 0V$, $\overline{SHDN} = V_{DD}$, $GAIN1 = GAIN2 = GND$ (SPKR = +9dB, HP = 0dB), HPS = GND, FS0 = FS1 = GND (800Hz), MGAIN = float (-6dB), SYNC_IN = V_{DD} (SSM), speaker load R_L connected between OUT_+ and OUT_-, unless otherwise noted, $R_L = \infty$. Headphone load R_{LH} connected between HPR/HPL to GND, $R_{LH} = \infty$. $C_{BIAS} = 1\mu F$ to GND, $C1 = 1\mu F$, $C2 = 1\mu F$. $T_A = T_{MIN}$ to T_{MAX} , unless otherwise noted. Typical values at $T_A = +25^\circ C$.) (Note 1)

PARAMETER	SYMBOL	CONDITIONS	MIN	TYP	MAX	UNITS
HEADPHONE AMPLIFIERS (MAX9706) (HPS = V_{DD})						
Output Power	P_{OUT}	HPV _{DD} = 3.3V to 5V, $T_A = +25^\circ C$, THD+N = 1% (Notes 2, 7)	$R_L = 32\Omega$	35	50	mW
			$R_L = 16\Omega$		95	
Total Harmonic Distortion Plus Noise	THD+N	$V_{OUT} = 1V_{RMS}$, $f = 1kHz$, bandwidth = 22Hz to 22kHz	$R_L = 32\Omega$		0.02	%
			$R_L = 16\Omega$		0.04	
Signal-to-Noise Ratio	SNR	$V_{OUT} = 1V_{RMS}$	Bandwidth = 22Hz to 22kHz		96	dB
			A-weighted		100	
Power-Supply Rejection Ratio	PSRR	HPV _{DD} = 3V to 5.5V		70	90	dB
		$f = 1kHz$, 100mV _{P-P} ripple (Note 3)			80	
		$f = 20kHz$, 100mV _{P-P} ripple (Note 3)			65	
Headphone Path Gain (Note 8)		GAIN2 = 0			0	dB
		GAIN2 = 1			3	
Output Offset Voltage	V_{OSHP}	HP_ to GND, $T_A = +25^\circ C$		± 0.7	± 3	mV
Crosstalk		HPL to HPR, HPR to HPL, $f_{IN} = 1kHz$, $P_{OUT} = 32mW$, $R_L = 32\Omega$		-60		dB
Slew Rate				0.5		V/ μs
Maximum Capacitive Load	C_L	No sustained oscillations		300		pF
HPS Pullup Impedance				600		k Ω
Debounce Time				65		ms
Output Impedance in Shutdown		HPS = GND or $\overline{SHDN} = GND$		1.4		k Ω
Charge-Pump Switching Frequency	f_{CP}			$f_{OSC} / 2$		kHz
Click-and-Pop Level	K_{CP}	Peak voltage, A-weighted, 32 samples per second (Note 6)	Into shutdown		52	dBV
			Out of shutdown		52	
LINE-LEVEL MONO OUTPUT (MONO_OUT)						
MONO_OUT Signal-Path Gain				0		dB
Output Impedance				0.1		Ω
Maximum Output Level		$R_L = 10k\Omega$		1		V _{RMS}
Total Harmonic Distortion Plus Noise	THD+N	$V_{OUT} = 1V_{RMS}$, $f_{IN} = 100Hz$, $R_L = 10k\Omega$, bandwidth = 22Hz to 22kHz		0.01		%
Maximum Capacitive Load	C_L	No sustained oscillations		200		pF

3-Channel, 2.3W, Filterless Class D Amplifiers with Active Crossover

MAX9706/MAX9707

ELECTRICAL CHARACTERISTICS (continued)

(V_{DD} = PV_{DD} = HPV_{DD} = 5V, GND = PGND = CPGND = 0V, $\overline{\text{SHDN}}$ = V_{DD}, GAIN1 = GAIN2 = GND (SPKR = +9dB, HP = 0dB), HPS = GND, FS0 = FS1 = GND (800Hz), MGAIN = float (-6dB), SYNC_IN = V_{DD} (SSM), speaker load R_L connected between OUT₊ and OUT₋, unless otherwise noted, R_L = ∞. Headphone load R_{LH} connected between HPR/HPL to GND, R_{LH} = ∞. C_{BIAS} = 1μF to GND, C1 = 1μF, C2 = 1μF. T_A = T_{MIN} to T_{MAX}, unless otherwise noted. Typical values at T_A = +25°C.) (Note 1)

PARAMETER	SYMBOL	CONDITIONS	MIN	TYP	MAX	UNITS
DIGITAL INPUTS (GAIN1, GAIN2, FS0, FS1, $\overline{\text{SHDN}}$, SYNC_IN, MGAIN)						
Input-Voltage High	V _{INH}		2			V
Input-Voltage Low	V _{INL}				0.8	V
Input Leakage Current		GAIN1, GAIN2, FS0, FS1, $\overline{\text{SHDN}}$			±1	μA
Input Current		SYNC_IN, MGAIN			±50	μA
Pullup Impedance		SYNC_IN, MGAIN		200		kΩ
DIGITAL OUTPUT (SYNC_OUT)						
Output-Voltage High	V _{OH}	I _{OH} = 1mA	V _{DD} × 0.9			V
Output-Voltage Low	V _{OL}	I _{OL} = 1mA			V _{DD} × 0.1	V

Note 1: All devices are 100% tested at T_A = +25°C. Limits over temperature are guaranteed by design.

Note 2: Measured at 2kHz for OUTL₋, OUTR₋, HPL, and HPR; measured at 100Hz for OUTM₋.

Note 3: PSRR is measured with the inputs AC-grounded.

Note 4: Left/right signal-path gain is defined as:

$$\frac{|(V_{\text{OUT}_+}) - (V_{\text{OUT}_-})|}{|V_{\text{IN}_-}|}$$

MONO signal-path gain is defined as:

$$\frac{|(V_{\text{OUTM}_+}) - (V_{\text{OUTM}_-})|}{|(V_{\text{INL}}) + (V_{\text{INR}})|}$$

Note 5: MONO gain offset is measured with respect to speaker-path gain.

Note 6: Speaker mode testing performed with an 8Ω resistive load in series with a 68μH inductive load connected across BTL output. Headphone mode testing performed with a 32Ω resistive load connected between HP₋ and GND. Mode transitions are controlled by $\overline{\text{SHDN}}$.

Note 7: Headphone-path gain is defined as:

$$\frac{|V_{\text{HP}}|}{|V_{\text{IN}_-}|}$$

Note 8: Guaranteed by design only.

3-Channel, 2.3W, Filterless Class D Amplifiers with Active Crossover

Typical Operating Characteristics—Speaker Mode

($V_{DD} = PV_{DD} = HPV_{DD} = 5V$, $GND = PGND = CPGND = 0V$, $\overline{SHDN} = V_{DD}$, $GAIN1 = GAIN2 = GND (+9dB)$, $FS0 = FS1 = GND (800Hz)$, $MGAIN = float (-6dB)$, $SYNC_IN = V_{DD} (SSM)$, speaker load R_L connected between $OUT+$ and $OUT-$, unless otherwise noted, $R_L = \infty$. Headphone load R_{LH} connected between HPR/HPL to GND . $C_{BIAS} = 1\mu F$ to GND , $1\mu F$ capacitor between $C1P$ and $C1N$, $C_{VSS} = 1\mu F$. $T_A = T_{MIN}$ to T_{MAX} , unless otherwise noted. Typical values at $T_A = +25^\circ C$.)

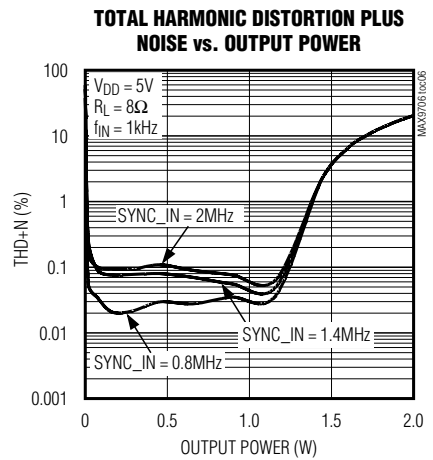
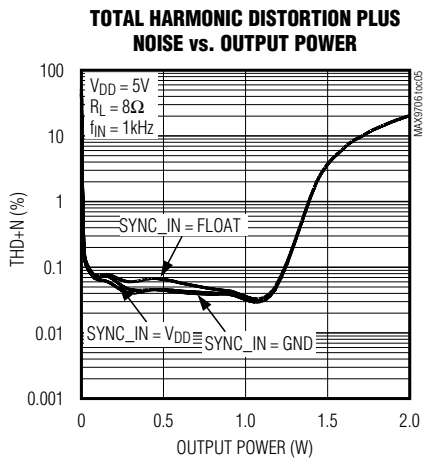
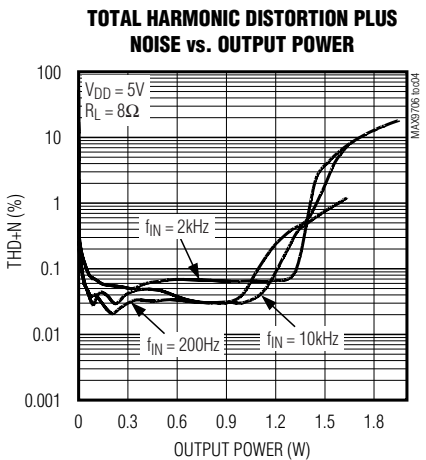
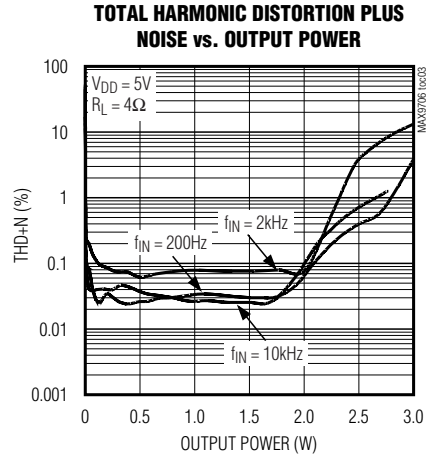
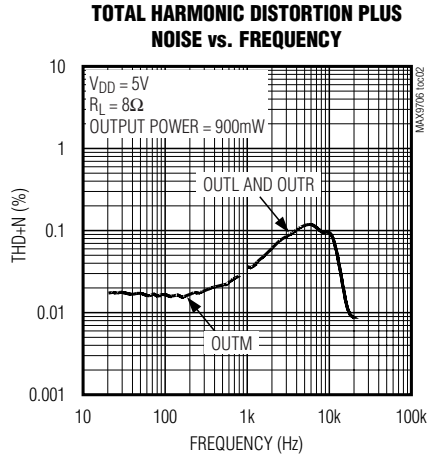
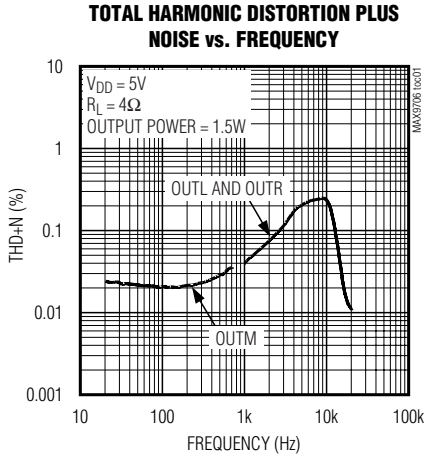

3-Channel, 2.3W, Filterless Class D Amplifiers with Active Crossover

MAX9706/MAX9707

Typical Operating Characteristics—Speaker Mode (continued)

($V_{DD} = PV_{DD} = HPV_{DD} = 5V$, $GND = PGND = CPGND = 0V$, $\overline{SHDN} = V_{DD}$, $GAIN1 = GAIN2 = GND (+9dB)$, $FS0 = FS1 = GND (800Hz)$, $MGAIN = float (-6dB)$, $SYNC_IN = V_{DD} (SSM)$, speaker load R_L connected between $OUT+$ and $OUT-$, unless otherwise noted, $R_L = \infty$. Headphone load R_{LH} connected between HPR/HPL to GND . $C_{BIAS} = 1\mu F$ to GND , $1\mu F$ capacitor between $C1P$ and $C1N$, $C_{VSS} = 1\mu F$. $T_A = T_{MIN}$ to T_{MAX} , unless otherwise noted. Typical values at $T_A = +25^\circ C$.)

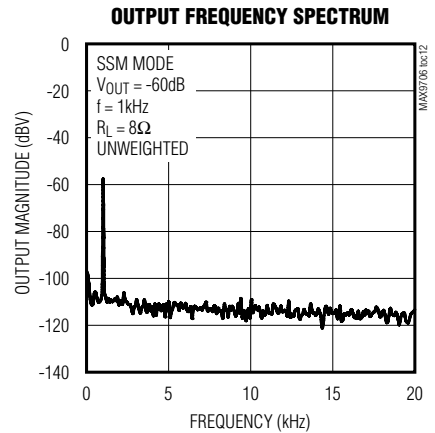
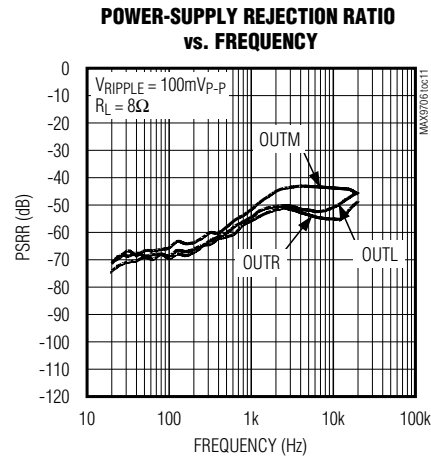
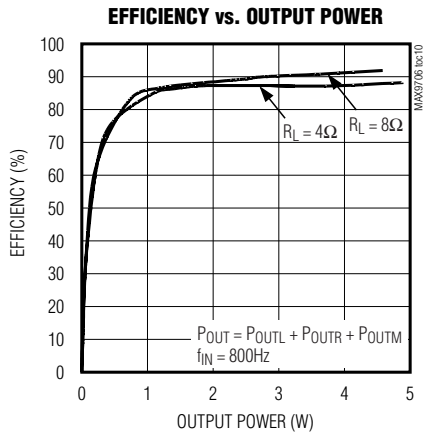
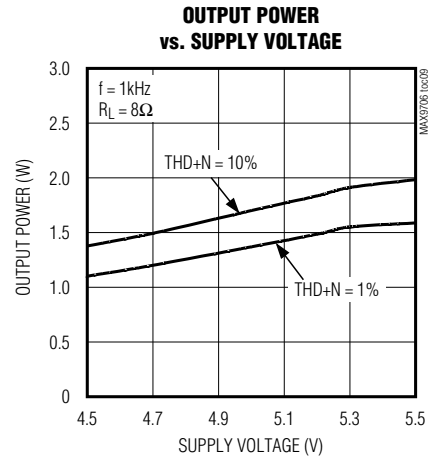
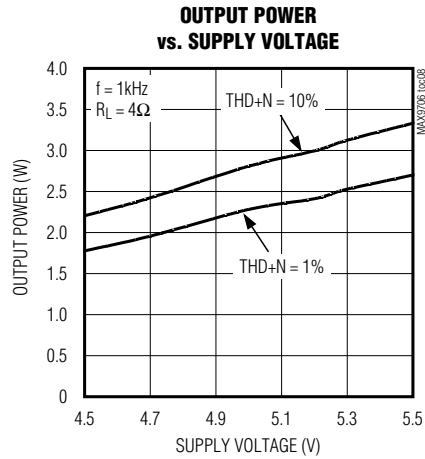
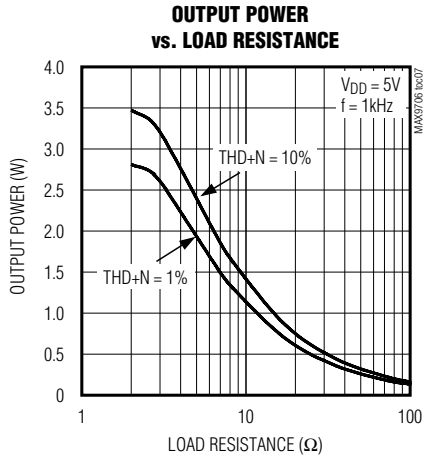

3-Channel, 2.3W, Filterless Class D Amplifiers with Active Crossover

Typical Operating Characteristics—Speaker Mode (continued)

($V_{DD} = PV_{DD} = HPV_{DD} = 5V$, $GND = PGND = CPGND = 0V$, $\overline{SHDN} = V_{DD}$, $GAIN1 = GAIN2 = GND$ (+9dB), $FS0 = FS1 = GND$ (800Hz), $MGAIN = float$ (-6dB), $SYNC_IN = V_{DD}$ (SSM), speaker load R_L connected between $OUT+$ and $OUT-$, unless otherwise noted, $R_L = \infty$. Headphone load R_{LH} connected between HPR/HPL to GND . $C_{BIAS} = 1\mu F$ to GND , $1\mu F$ capacitor between $C1P$ and $C1N$, $C_{VSS} = 1\mu F$. $T_A = T_{MIN}$ to T_{MAX} , unless otherwise noted. Typical values at $T_A = +25^\circ C$.)

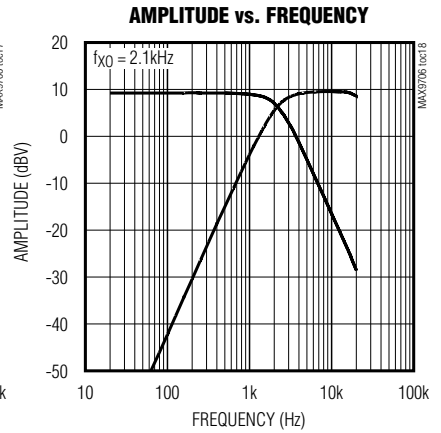
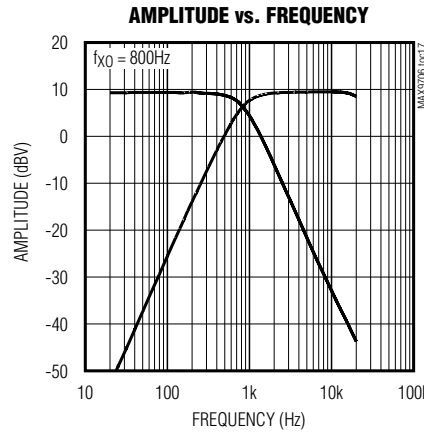
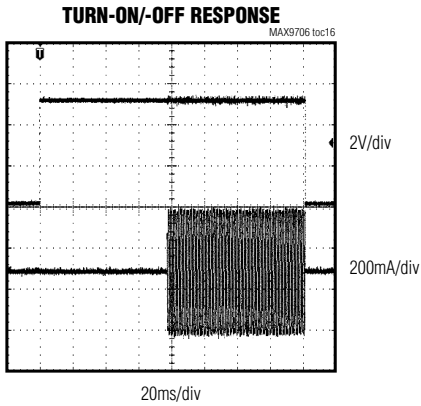
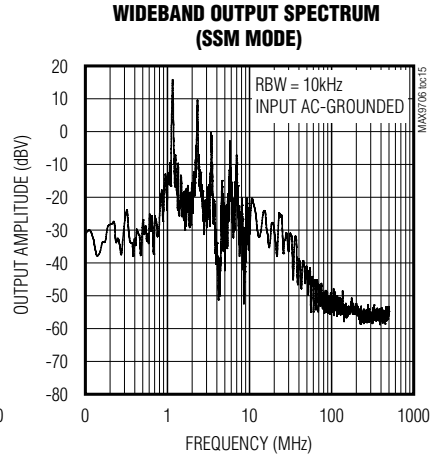
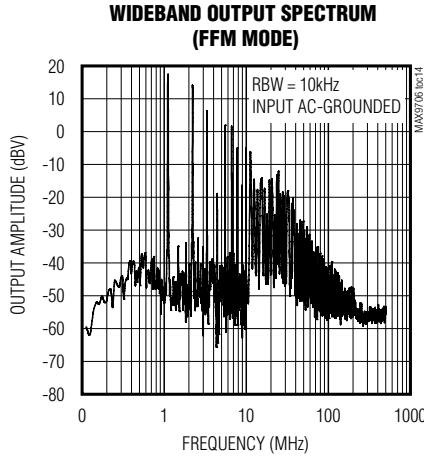
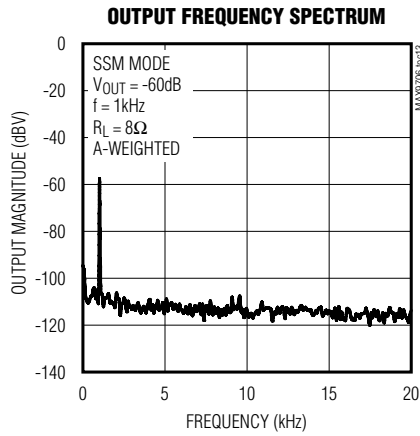

3-Channel, 2.3W, Filterless Class D Amplifiers with Active Crossover

MAX9706/MAX9707

Typical Operating Characteristics—Headphone Mode

($V_{DD} = PV_{DD} = HPV_{DD} = 5V$, $GND = PGND = CPGND = 0V$, $\overline{SHDN} = V_{DD}$, $GAIN1 = GAIN2 = GND (+9dB)$, $FS0 = FS1 = GND (800Hz)$, $MGAIN = float (-6dB)$, $SYNC_IN = V_{DD} (SSM)$, speaker load R_L connected between $OUT+$ and $OUT-$, unless otherwise noted, $R_L = \infty$. Headphone load R_{LH} connected between HPR/HPL to GND . $C_{BIAS} = 1\mu F$ to GND , $1\mu F$ capacitor between $C1P$ and $C1N$, $C_{VSS} = 1\mu F$. $T_A = T_{MIN}$ to T_{MAX} , unless otherwise noted. Typical values at $T_A = +25^\circ C$.)

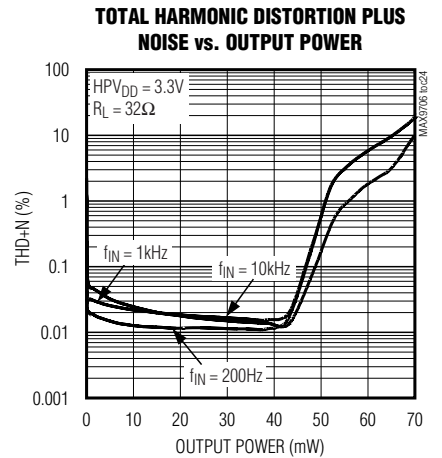
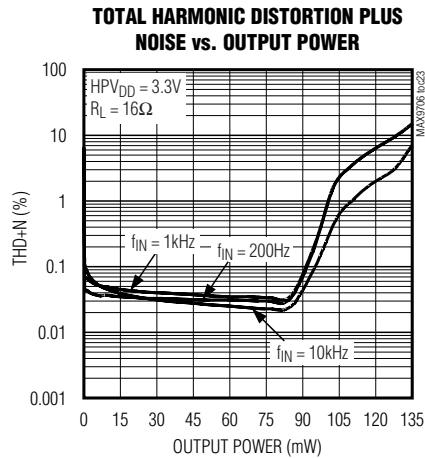
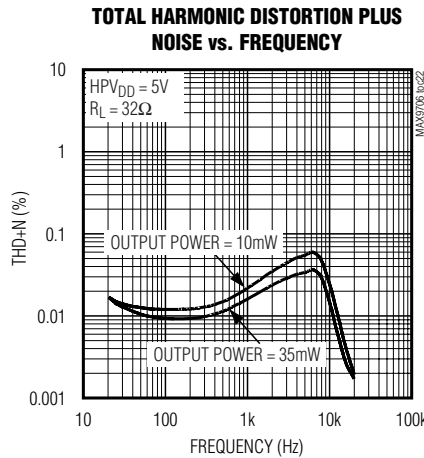
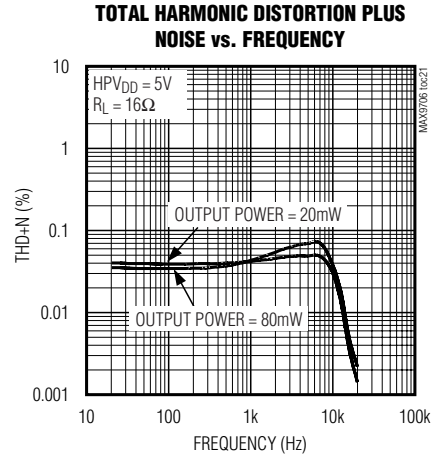
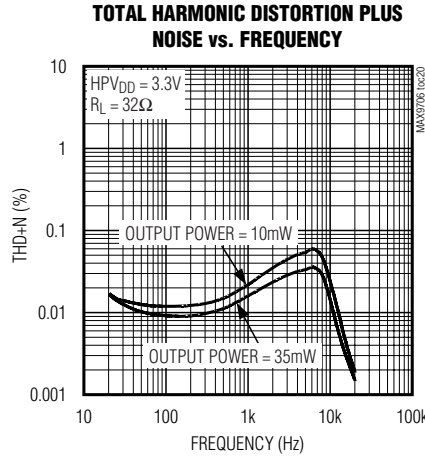
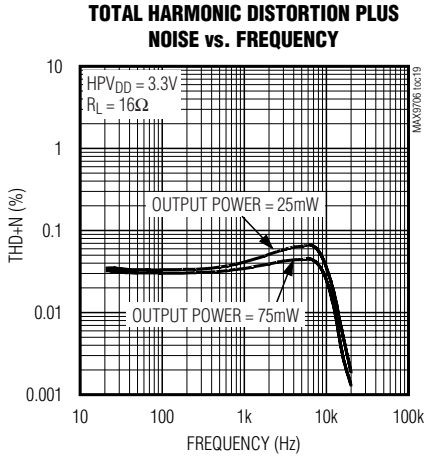

3-Channel, 2.3W, Filterless Class D Amplifiers with Active Crossover

Typical Operating Characteristics—Headphone Mode (continued)

($V_{DD} = PV_{DD} = HPV_{DD} = 5V$, $GND = PGND = CPGND = 0V$, $\overline{SHDN} = V_{DD}$, $GAIN1 = GAIN2 = GND (+9dB)$, $FS0 = FS1 = GND (800Hz)$, $MGAIN = float (-6dB)$, $SYNC_IN = V_{DD} (SSM)$, speaker load R_L connected between $OUT+$ and $OUT-$, unless otherwise noted, $R_L = \infty$. Headphone load R_{LH} connected between HPR/HPL to GND . $C_{BIAS} = 1\mu F$ to GND , $1\mu F$ capacitor between $C1P$ and $C1N$, $C_{VSS} = 1\mu F$. $T_A = T_{MIN}$ to T_{MAX} , unless otherwise noted. Typical values at $T_A = +25^\circ C$.)

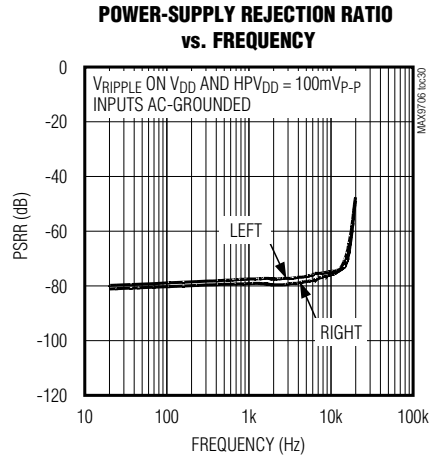
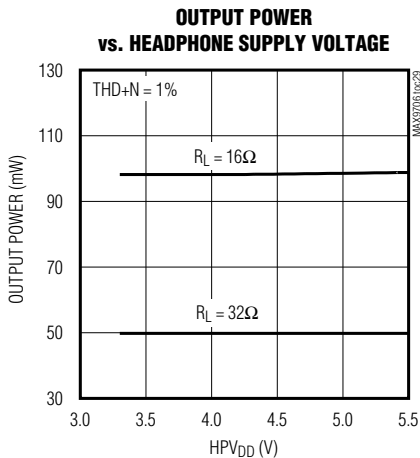
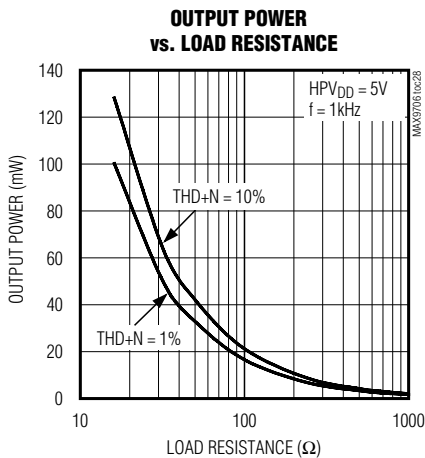
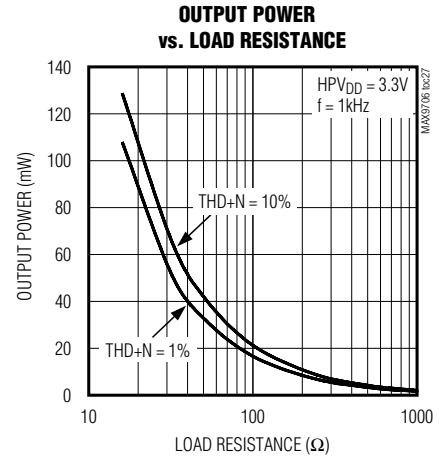
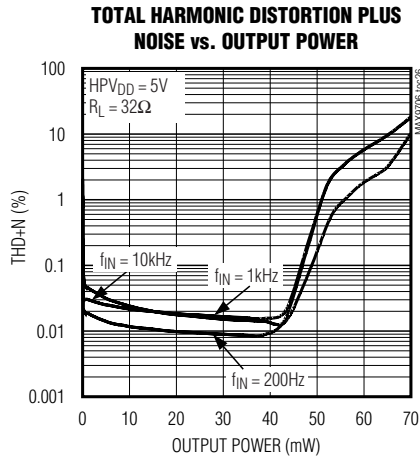
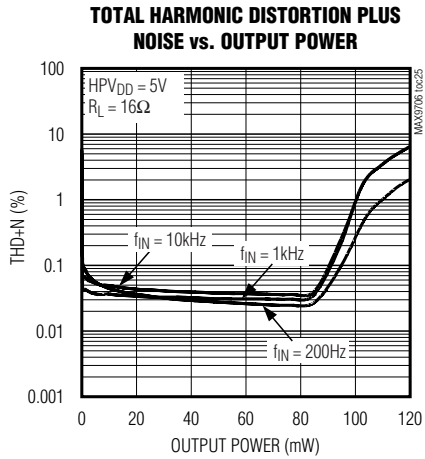

3-Channel, 2.3W, Filterless Class D Amplifiers with Active Crossover

MAX9706/MAX9707

Typical Operating Characteristics—Headphone Mode (continued)

($V_{DD} = PV_{DD} = HPV_{DD} = 5V$, $GND = PGND = CPGND = 0V$, $\overline{SHDN} = V_{DD}$, $GAIN1 = GAIN2 = GND (+9dB)$, $FS0 = FS1 = GND (800Hz)$, $MGAIN = float (-6dB)$, $SYNC_IN = V_{DD} (SSM)$, speaker load R_L connected between $OUT+$ and $OUT-$, unless otherwise noted, $R_L = \infty$. Headphone load R_{LH} connected between HPR/HPL to GND . $C_{BIAS} = 1\mu F$ to GND , $1\mu F$ capacitor between $C1P$ and $C1N$, $C_{VSS} = 1\mu F$. $T_A = T_{MIN}$ to T_{MAX} , unless otherwise noted. Typical values at $T_A = +25^\circ C$.)

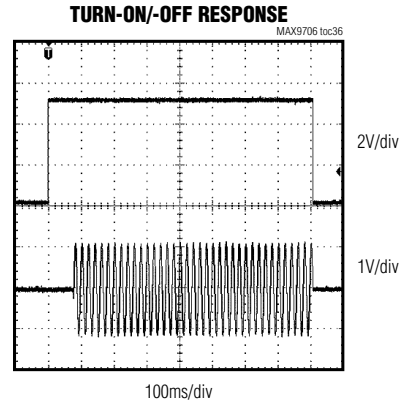
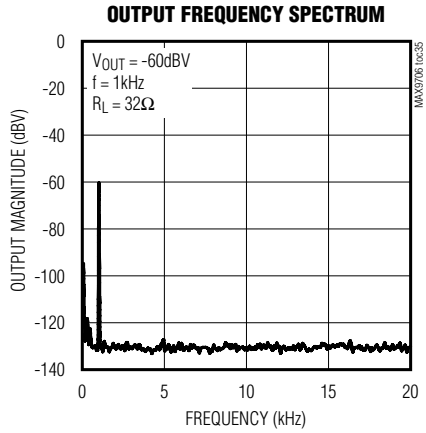
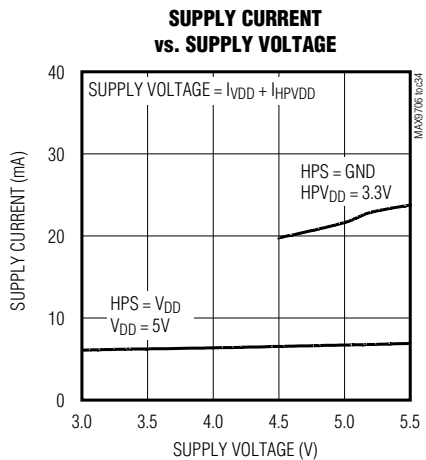
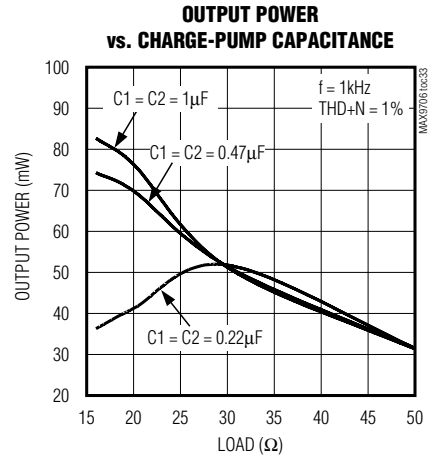
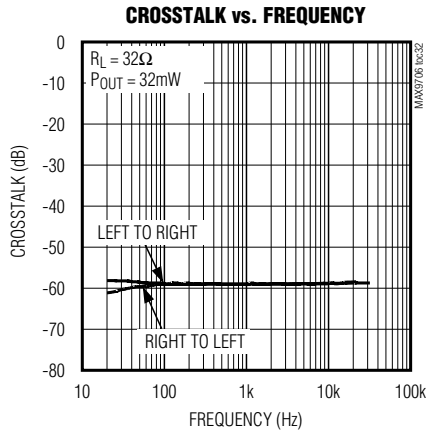
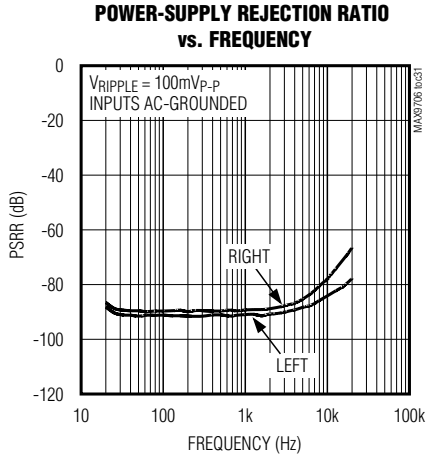

3-Channel, 2.3W, Filterless Class D Amplifiers with Active Crossover

Pin Description

PIN		NAME	FUNCTION
MAX9706	MAX9707		
1	1	BIAS	Internal Bias. Bypass BIAS to GND with a 1 μ F capacitor.
2	2	GND	Ground. Star connect to PGND (see the <i>Supply Bypassing, Layout, and Grounding</i> section).
3	3	V _{DD}	Main Power Supply. Connect V _{DD} to a low-noise 5V source. Bypass V _{DD} to GND with a 1 μ F capacitor.
4	4	SYNC_OUT	Synchronization Clock Output. Connect SYNC_OUT to other Class D amplifiers to maintain synchronization. SYNC_OUT is a CMOS output proportional to V _{DD} . Float SYNC_OUT, if not used.
5, 23, 31	5, 23, 31	PGND	Power Ground. PGND is the ground connection for the speaker amplifiers.
6	6	OURL-	Left-Speaker Negative Terminal
7	7	OURL+	Left-Speaker Positive Terminal
8, 20, 34	8, 20, 34	PV _{DD}	Output Power Supply. PV _{DD} is the power connection for the speaker amplifiers. Connect to V _{DD} . Bypass each PV _{DD} to its corresponding PGND with a 1 μ F capacitor.
9	—	CPV _{DD}	Charge-Pump Positive Supply. Connect CPV _{DD} to HPV _{DD} . Bypass CPV _{DD} to CPGND with a 1 μ F capacitor.
10	—	C1P	Charge-Pump Flying Capacitor Positive Terminal. Connect a 1 μ F capacitor from C1P to C1N.
11	—	CPGND	Charge-Pump Ground. Connect to PGND.
12	—	C1N	Charge-Pump Flying Capacitor Negative Terminal. Connect a 1 μ F capacitor from C1N to C1P.
13	—	CPV _{SS}	Negative Supply Charge-Pump Output. Bypass CPV _{SS} to PGND with a 1 μ F capacitor. Connect CPV _{SS} to V _{SS} .
14	14	SYNC_IN	Frequency Select or External Clock Input. Connect SYNC_IN to GND, V _{DD} , leave floating, or drive with an externally generated clock to control the switching frequency of the Class D amplifiers. See Table 1.
15	—	HPS	Headphone Sense. HPS is a digital input with a pullup resistor to detect the connection of a headphone. When HPS is high, the headphone amplifier is enabled and the Class D speaker amplifiers are disabled. See the <i>Headphone Sense Input (HPS)</i> section.
16	—	V _{SS}	Headphone Amplifier Negative Supply. Connect V _{SS} to CPV _{SS} .
17	—	HPR	Right Headphone Output
18	—	HPL	Left Headphone Output
19	—	HPV _{DD}	Positive Supply for Headphone Amplifiers. Connect HPV _{DD} to V _{DD} . Bypass HPV _{DD} to PGND with a 0.1 μ F capacitor.
21	21	OUTR+	Right-Speaker Positive Terminal
22	22	OUTR-	Right-Speaker Negative Terminal
24	24	$\overline{\text{SHDN}}$	Shutdown Input. Drive $\overline{\text{SHDN}}$ low to put the MAX9706/MAX9707 in low-power shutdown mode. Drive $\overline{\text{SHDN}}$ high or connect to V _{DD} to enable normal operation.
25	25	FS0	Crossover Frequency Select. Connect FS0 and FS1 to GND or V _{DD} to set the crossover frequency. See Table 4.
26	26	FS1	

3-Channel, 2.3W, Filterless Class D Amplifiers with Active Crossover

MAX9706/MAX9707

Pin Description (continued)

PIN		NAME	FUNCTION
MAX9706	MAX9707		
27	27	INR	Right-Channel Audio Input. Connect the right-channel audio signal to INR with a series capacitor. INR has a 25k Ω typical input impedance.
28	28	MGAIN	Mono Gain Control. Connect MGAIN to GND, V _{DD} , or leave floating to set the gain of the MONO channel with respect to the left and right channels. See Table 3.
29	29	GAIN2	Amplifier Gain-Control Input. Connect GAIN1 and GAIN2 to GND or V _{DD} to set the gain of the left and right channels. See Tables 2 and 4.
30	30	GAIN1	Amplifier Gain-Control Input. Connect GAIN1 and GAIN2 to GND or V _{DD} to set the gain of the left and right channels. See Tables 2 and 4.
32	32	OUTM-	Mono-Speaker Negative Terminal
33	33	OUTM+	Mono-Speaker Positive Terminal
35	35	MONO_OUT	Mono Line-Level Output. MONO_OUT is the monaural output of the summed left and right low-frequency signals.
36	36	INL	Left-Channel Audio Input. Connect the left-channel audio signal to INL with a series capacitor. INL has a 25k Ω typical input impedance.
—	9–13, 16–19	N.C.	No Connection. Not internally connected.
—	15	I.C.	Internally Connected. Connect to GND.
EP	EP	EP	Exposed Pad. The external pad lowers the package's thermal impedance by providing a direct heat conduction path from the die to the PC board. The exposed pad is not internally connected. Connect the exposed pad to GND.

Detailed Description

The MAX9706/MAX9707 combine three high-efficiency Class D amplifiers with an active crossover to provide stereo highpass outputs, and a mono lowpass output (Figure 1). All three channels deliver up to 2.3W per channel into 4 Ω when operating from a 5V supply.

An internal active filter processes the stereo inputs (left and right) into stereo highpass and mono lowpass outputs. The crossover frequency is pin-selectable to four different frequencies to accommodate a variety of speaker configurations.

The internal Class D amplifiers feature low-EMI, spread-spectrum outputs. No output filters are required.

The MAX9706 features Maxim's DirectDrive headphone amplifier, providing ground-referenced headphone outputs without the need for bulky coupling capacitors. The headphone outputs are capable of delivering 95mW per channel into 16 Ω from a 3.3V supply, and are protected against ESD up to ± 8 kV.

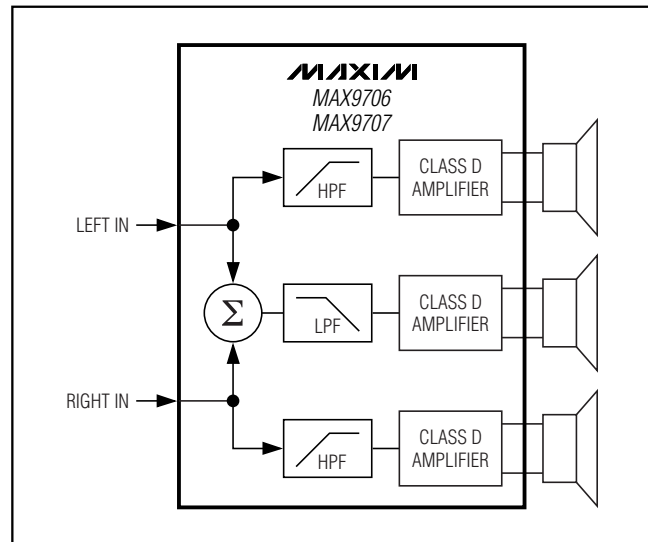

Figure 1. Speaker Arrangement

3-Channel, 2.3W, Filterless Class D Amplifiers with Active Crossover

Class D Speaker Amplifier

Spread-spectrum modulation and synchronizable switching frequency significantly reduce EMI emissions. Comparators monitor the audio inputs and compare the complementary input voltages to a sawtooth waveform. The comparators trip when the input magnitude of the sawtooth exceeds their corresponding input voltage. Both comparators reset at a fixed time after the rising edge of the second comparator trip point, generating a minimum-width pulse ($t_{ON(MIN)}$, 100ns typ) at the output of the second comparator (Figure 2). As the input voltage increases or decreases, the duration of the pulse at one output increases while the other output pulse duration remains the same. This causes the net voltage across the speaker ($V_{OUT+} - V_{OUT-}$) to change. The minimum-width pulse helps the device to achieve high levels of linearity.

Operating Modes

Fixed-Frequency (FFM) Mode

The MAX9706/MAX9707 feature two fixed-frequency modes. Connect SYNC_IN to GND to select a 1.1MHz switching frequency. Float SYNC to select a 1.34MHz switching frequency. The frequency spectrum of the MAX9706/MAX9707 consists of the fundamental switching frequency and its associated harmonics (see the Wideband Output Spectrum graph in the *Typical Operating Characteristics*). Program the switching frequency so the harmonics do not fall within a sensitive frequency band (Table 1). Audio reproduction is not affected by changing the switching frequency.

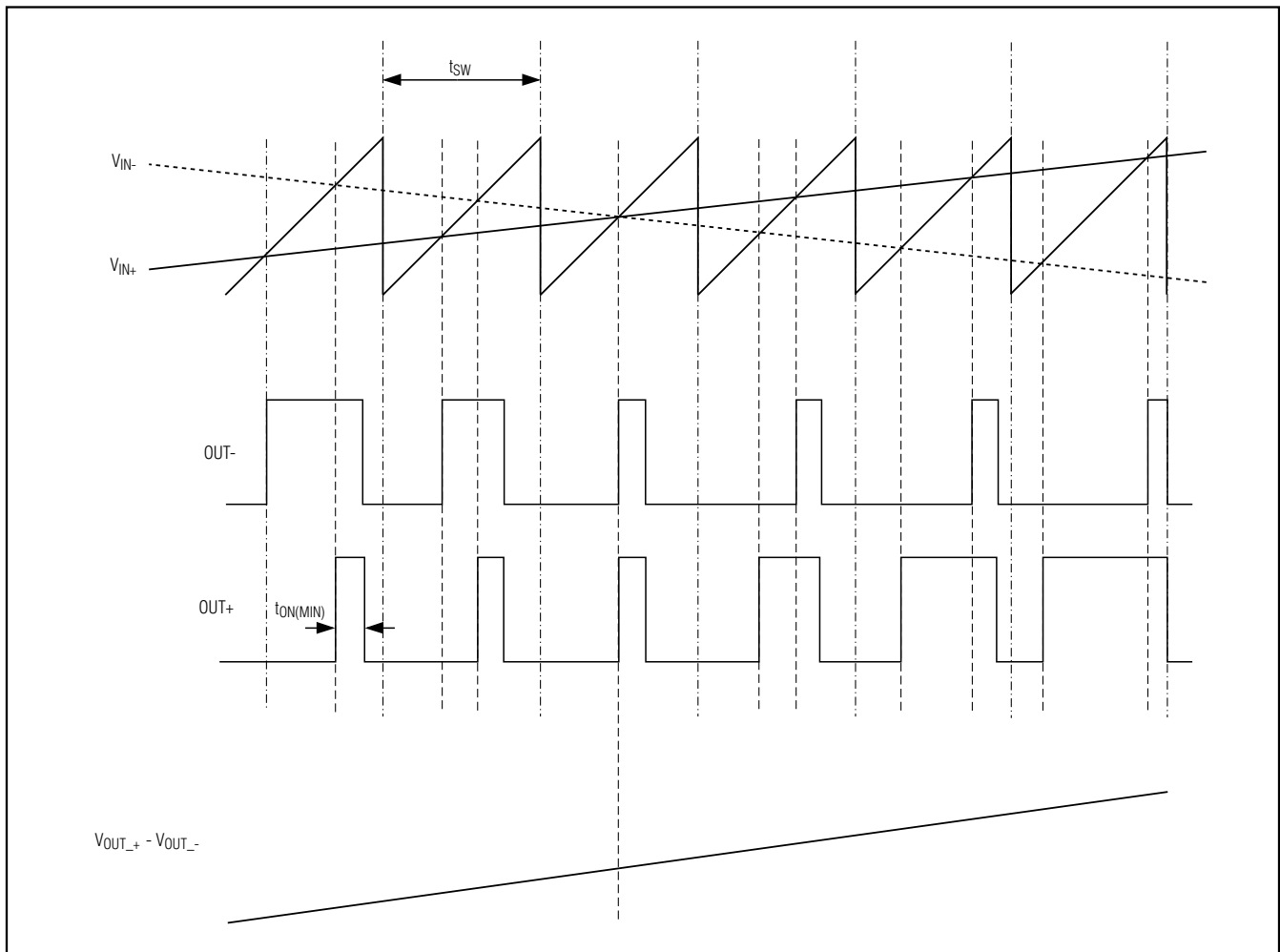

Figure 2. Outputs with an Input Signal Applied (FFM Mode)

3-Channel, 2.3W, Filterless Class D Amplifiers with Active Crossover

Spread-Spectrum (SSM) Mode

The MAX9706/MAX9707 feature a unique spread-spectrum mode that flattens the wideband spectral components, improving EMI emissions that can be radiated by the speaker and cables. Enable SSM mode by setting SYNC_IN = V_{DD} (Table 1). In SSM mode, the switching frequency varies randomly by ±50kHz around the center frequency (1.15MHz). The modulation scheme remains the same, but the period of the sawtooth waveform changes from cycle to cycle (Figure 3). Instead of a large amount of spectral energy present at multiples of the switching frequency, the energy is now spread over a bandwidth that increases with frequency. Above a few megahertz, the wideband spectrum looks like white noise for EMI purposes. A proprietary amplifier topology ensures this does not corrupt the noise floor in the audio bandwidth.

Table 1. Operating Modes

SYNC_IN	MODE
GND	FFM with $f_{OSC} = 1100\text{kHz}$
FLOAT	FFM with $f_{OSC} = 1340\text{kHz}$
V _{DD}	SSM with $f_{OSC} = 1150\text{kHz} \pm 50\text{kHz}$
Clocked	FFM with $f_{OSC} = \text{external clock frequency}$

MAX9706/MAX9707

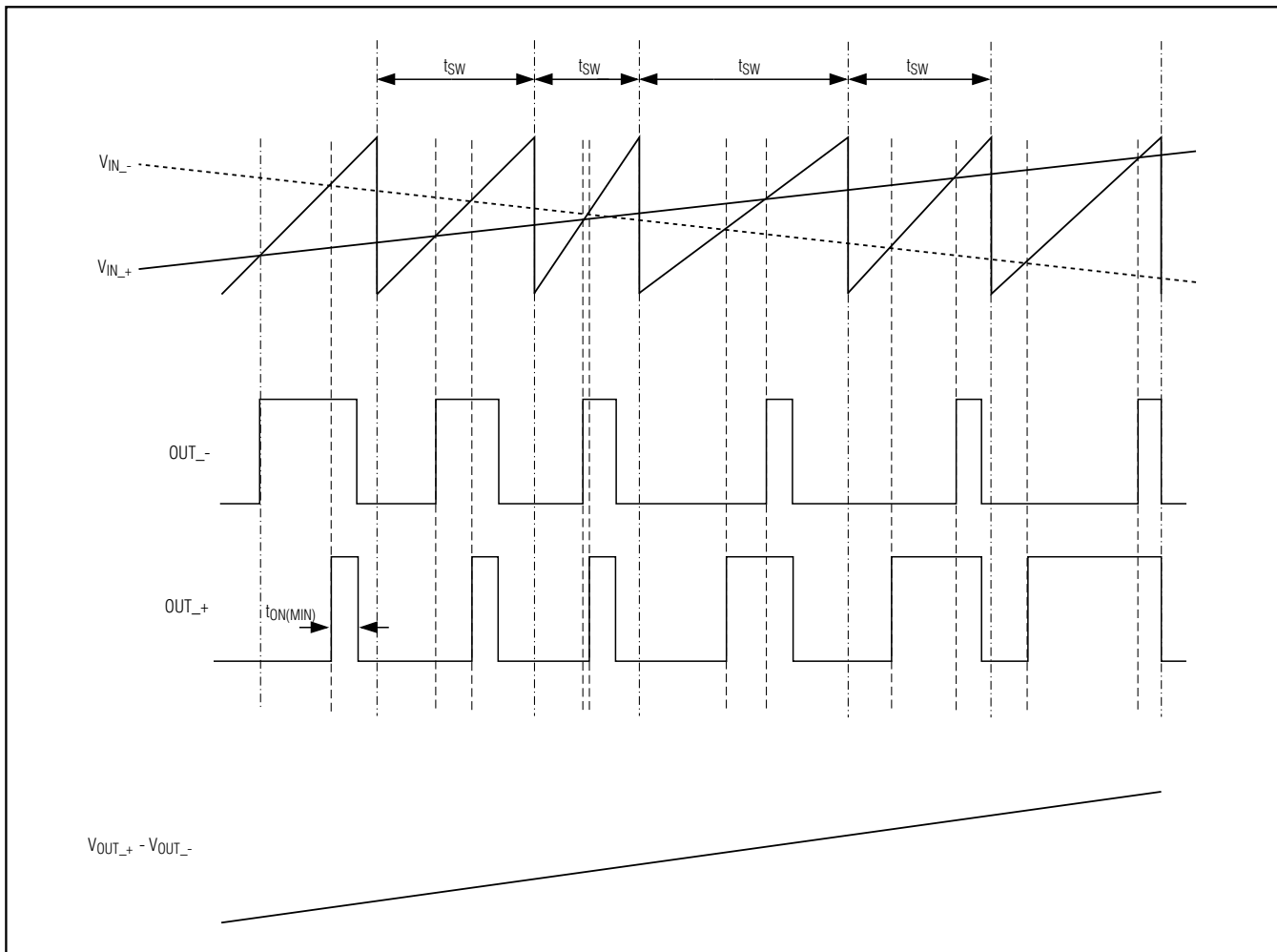

Figure 3. Output with an Input Signal Applied (SSM Mode)

3-Channel, 2.3W, Filterless Class D Amplifiers with Active Crossover

External Clock Mode

The SYNC_IN input allows the MAX9706/MAX9707 to be synchronized to an external clock, or another Maxim Class D amplifier. This creates a fully synchronous system, minimizing clock intermodulation, and allocating spectral components of the switching harmonics to insensitive frequency bands. Applying a TTL clock signal between 1MHz and 1.5MHz to SYNC_IN synchronizes the MAX9706/MAX9707. The period of the SYNC_IN clock can be randomized, allowing the MAX9706/MAX9707 to be synchronized to another Maxim Class D amplifier operating in SSM mode.

SYNC_OUT allows several MAX9706/MAX9707s to be cascaded. The synchronized output minimizes any interference due to clock intermodulation caused by the switching spread between single devices. The modulation scheme remains the same when using SYNC_OUT, and audio reproduction is not affected. Leave SYNC_OUT floating if not used.

Filterless Modulation/Common-Mode Idle

The MAX9706/MAX9707 use Maxim's unique modulation scheme that eliminates the LC filter required by traditional Class D amplifiers, improving efficiency, reducing component count, conserving board space and system cost. Conventional Class D amplifiers output a 50% duty-cycle square wave when no signal is present. With no filter, the square wave appears across the load as a DC voltage, resulting in finite load current, increasing power consumption, especially when idling. When no signal is present at the input of the MAX9706/MAX9707, the outputs switch as shown in Figure 4. Because the MAX9706/MAX9707 drive the speaker differentially, the two outputs cancel each other, resulting in no net idle-mode voltage across the speaker, minimizing power consumption.

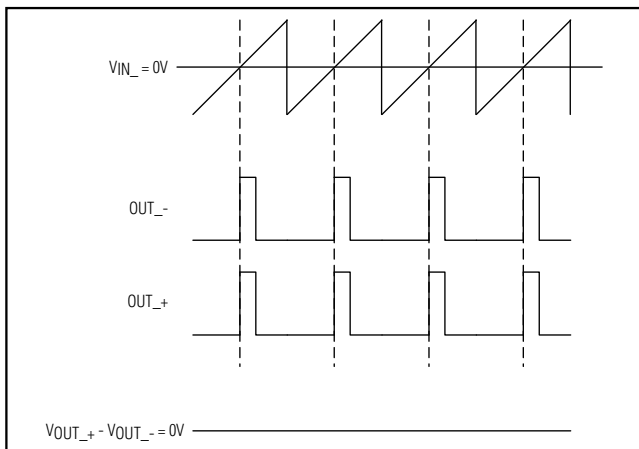

Figure 4. Outputs with No Input Signal

Efficiency

Efficiency loss of a Class D amplifier is due to the switching operation of the output stage transistors. In a Class D amplifier, the output transistors act as current-steering switches and consume negligible additional power. Any power loss associated with the Class D output stage is mostly due to the I^2R loss of the MOSFET on-resistance, and quiescent current overhead.

The theoretical best efficiency of a Class AB linear amplifier is 78%, however, that efficiency is only exhibited at peak output powers. Under normal operating levels (typical music reproduction levels), efficiency falls below 30%, whereas the MAX9706/MAX9707 still exhibit >90% efficiencies under the same conditions (Figure 5).

Signal Path Gain

The MAX9706/MAX9707 feature four selectable speaker gain and two headphone gain settings controlled by two gain-control inputs GAIN1 and GAIN2 (see Table 2).

Note that the stereo headphone output is full bandwidth, but the stereo speaker outputs are highpass filtered by the crossover circuitry.

Table 2. Speaker Gain

GAIN2	GAIN1	SPEAKER GAIN (dB)	MAX9706 HEADPHONE GAIN (dB)
0	0	+9	0
0	1	+10.5	0
1	0	+12	+3
1	1	+13.5	+3

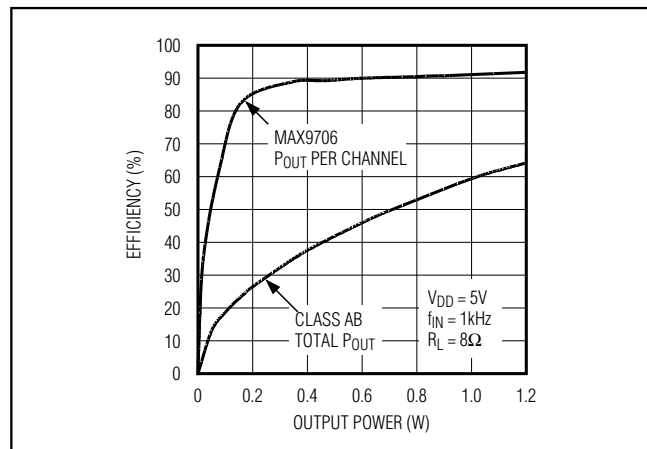

Figure 5. Efficiency vs. Class AB Efficiency

3-Channel, 2.3W, Filterless Class D Amplifiers with Active Crossover

Table 3. Mono Speaker Gain

MGAIN	MONO SPEAKER GAIN OFFSET (dB)
GND	-4.5
FLOATING	-6.0
V _{DD}	-7.5

Table 4. Crossover Frequency Selection

FS0	FS1	CROSSOVER FREQUENCY (f _{x0}) (Hz)
0	0	800
0	1	1066.7
1	0	1600
1	1	2133.3

Mono Output

The left and right channels are summed and passed through a lowpass filter to generate the mono output. The mono speaker gain offset is an attenuation of the selected speaker gain. The MAX9706/MAX9707 offer three options for this summing gain. Select mono output gain by setting MGAIN high, low, or leave floating (see Table 3).

The left- and right-speaker impedance should be twice that of the MONO channel (8Ω L/R, 4Ω MONO), then from the same voltage swing, the mono speaker will have 2 times the power. Over the left and right mono channels, a 1.5dB increase improves matching between the high- and low-frequency drivers.

Crossover Frequency

The MAX9706/MAX9707 feature an internal active filter with adjustable crossover frequency (f_{x0}) for use with a low-frequency transducer. The crossover filter consists of a complementary 2nd-order lowpass and 2nd-order highpass Butterworth filter (Figure 6). Crossover frequency is variable over the 800Hz to 2133.3Hz range to accommodate different speaker types. There are four selectable crossover frequencies selected by FS0 and FS1 (Table 4).

The BTL outputs provide the option of phase-inverting the mono (LF) output with respect to the main (L/R) outputs. Depending on the speaker placement and distance from the listener, this can smooth the crossover transition between low and high frequencies.

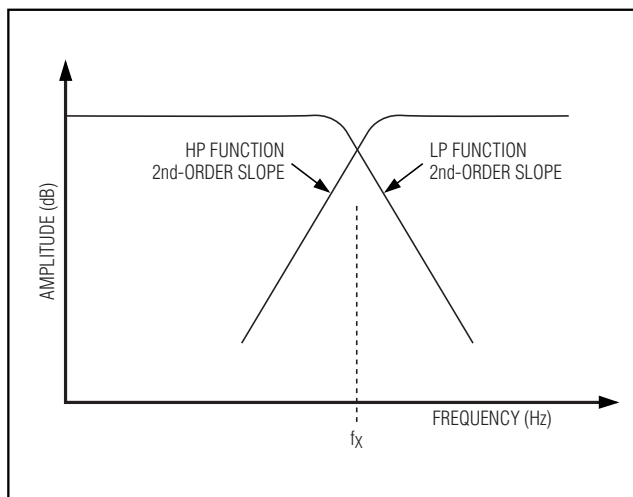

Figure 6. Crossover Frequency

Headphone Amplifier (MAX9706)

In conventional single-supply headphone amplifiers, the output-coupling capacitor is a major contributor of audible clicks and pops. Upon startup, the amplifier charges the coupling capacitor to its bias voltage, typically half the supply. Likewise, during shutdown, the capacitor is discharged to GND. This results in a DC shift across the capacitor, which in turn appears as an audible transient at the speaker. Since the MAX9706 headphone amplifier does not require output-coupling capacitors, no audible transients appear.

The MAX9706 offers 0dB and 3dB headphone amplifier gain settings controlled through the GAIN2 gain-select input (see Table 2).

DirectDrive

Traditional single-supply headphone amplifiers have outputs biased at a nominal DC voltage (typically half the supply) for maximum dynamic range. Large coupling capacitors are needed to block this DC bias from the headphone. Without these capacitors, a significant amount of DC current flows to the headphone, resulting in unnecessary power dissipation and possible damage to both headphone and headphone amplifier.

Maxim's DirectDrive architecture uses a charge pump to create an internal negative supply voltage. This allows the headphone outputs of the MAX9706 to be biased at GND, almost doubling dynamic range while operating from a single supply (Figure 7). With no DC component, there is no need for the large DC-blocking capacitors. Instead of two large (220μF, typical)

3-Channel, 2.3W, Filterless Class D Amplifiers with Active Crossover

tantalum-blocking capacitors, the MAX9706 charge pump requires two small ceramic capacitors, conserving board space, reducing cost, and improving the frequency response of the headphone amplifier. See the Output Power vs. Charge-Pump Capacitance graph in the *Typical Operating Characteristics* for details on sizing charge-pump capacitors. There is a low DC voltage on the driver outputs due to amplifier offset. However, the offset of the MAX9706 is typically 1.7mV, which, when combined with a 32Ω load, results in less than $53\mu\text{A}$ of DC current flow to the headphones.

In addition to the cost and size disadvantages of the DC-blocking capacitors required by conventional headphone amplifiers, these capacitors limit the amplifier's low-frequency response and can distort the audio signal (Figure 8). Previous attempts at eliminating the output-coupling capacitors involved biasing the headphone return (sleeve) to the DC bias voltage of the headphone amplifiers. This method raises some issues:

- 1) The sleeve is typically grounded to the chassis. Using the midrail biasing approach, the sleeve must be isolated from system ground, complicating product design.
- 2) During an ESD strike, the driver's ESD structures are the only path to system ground. Thus, the driver must be able to withstand the full ESD strike.

When using the headphone jack as a line out to other equipment, the bias voltage on the sleeve may conflict with the ground potential from other equipment, resulting in possible damage to the drivers.

Charge Pump

The MAX9706 features a low-noise charge pump. The switching frequency of the charge pump is one-half the switching frequency of the Class D amplifier, regardless of the operating mode. When SYNC_IN is driven externally, the charge pump switches at $1/2 f_{\text{SYNC_IN}}$. When SYNC_IN = V_{DD}, the charge pump switches with a spread-spectrum pattern. The nominal switching frequency is well beyond the audio range, and thus does not interfere with the audio signals, resulting in an SNR of 96dB. The switch drivers feature a controlled switching speed that minimizes noise generated by turn-on and turn-off transients. By limiting the switching speed of the charge pump, the di/dt noise caused by the parasitic bond wire and trace inductance is minimized. Although not typically required, additional high-frequency noise attenuation can be achieved by increasing the size of the charge-pump reservoir capacitor C2 (see the *Functional Diagram/Typical Operating Circuits*). The charge pump is active in both speaker and headphone modes.

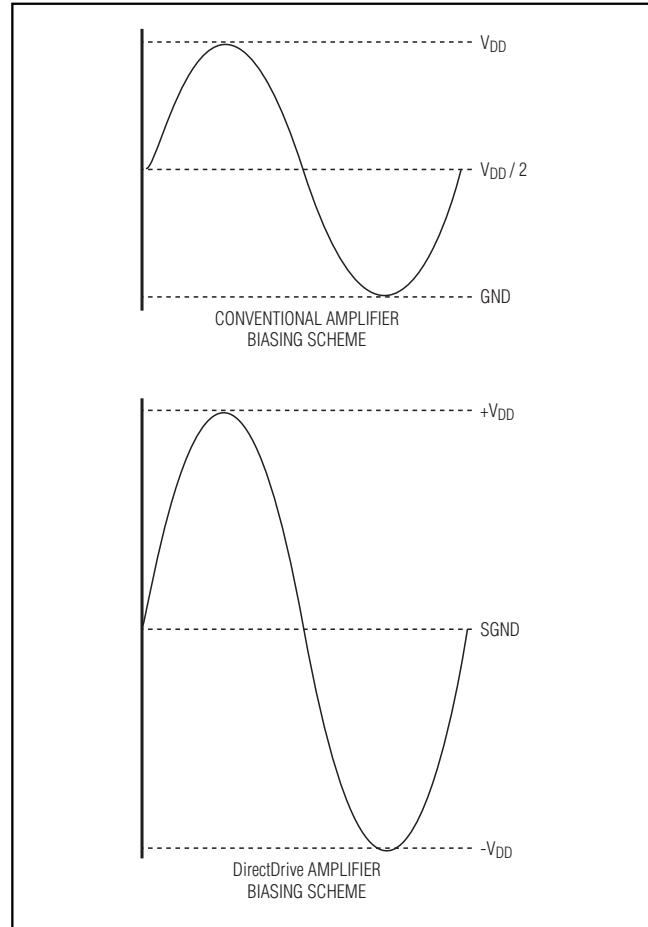

Figure 7. Traditional Amplifier Output vs. MAX9706 DirectDrive Output

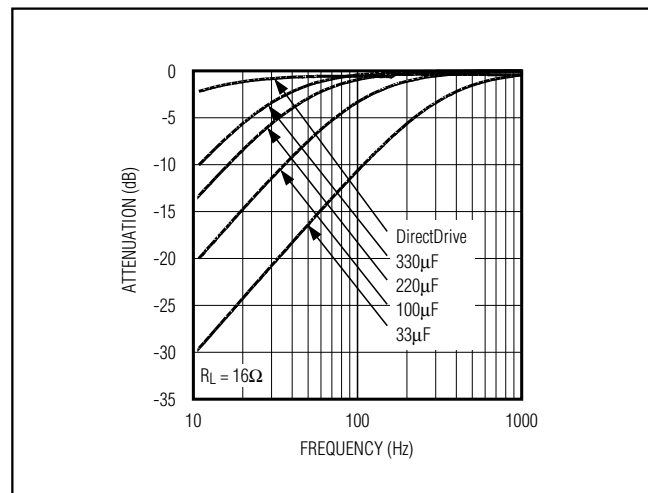

Figure 8. Low-Frequency Roll-off

3-Channel, 2.3W, Filterless Class D Amplifiers with Active Crossover

Headphone Sense Input (HPS)

The headphone sense input (HPS) monitors the headphone jack, and automatically configures the MAX9706 based upon the voltage applied at HPS. A voltage of less than 0.8V sets the MAX9706 to speaker mode and disables the headphone amplifiers. A voltage of greater than 2V disables the speaker amplifiers and enables the headphone amplifiers. The HPS input features a built-in 65ms debounce period to prevent audible “chatter” when inserting or removing headphones.

For automatic headphone detection, connect HPS to the control pin of a 3-wire headphone jack as shown in Figure 9. With no headphone present, the output impedance of the headphone amplifier pulls HPS to less than 0.8V. When a headphone plug is inserted into the jack, the control pin is disconnected from the tip contact and HPS is pulled to V_{DD} through the internal 600kΩ pullup. When driving HPS from an external logic source, drive HPS low when the MAX9706 is shut down. Place a 10kΩ resistor in series with HPS and the headphone jack to ensure high ESD protection.

Click-and-Pop Suppression

The MAX9706/MAX9707 feature comprehensive click-and-pop suppression that eliminates audible transients on startup and shutdown.

While in shutdown, the H-bridge is in a high-impedance state. During startup or power-up, the input amplifiers are muted and an internal loop sets the modulator bias voltages to the correct levels, preventing clicks and pops when the H-bridge is subsequently enabled.

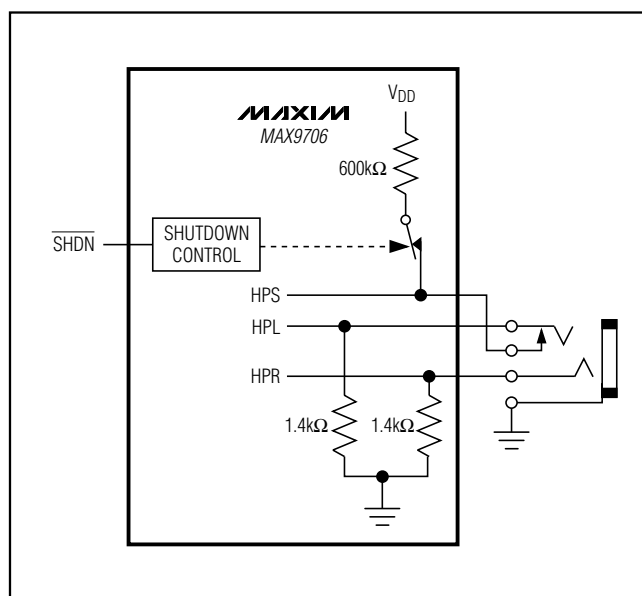

Figure 9. HPS Configuration

Current Limit and Thermal Protection

The MAX9706/MAX9707 feature current limiting and thermal protection to protect the device from short circuits and overcurrent conditions. If the current on any output exceeds the current limit (1.5A typ) the internal circuitry shuts off for 50μs then turns back on. If the overload condition is still present after 50μs, the internal circuitry shuts off again. The amplifier output pulses in the event of a continuous overcurrent condition. The headphone amplifier outputs become high impedance in the event of an overcurrent condition. The speaker amplifier’s current-limiting protection clamps the output current without shutting down the outputs.

The MAX9706/MAX9707 feature thermal-shutdown protection with temperature hysteresis. A rising die temperature shuts down the device at +150°C. When the die cools down to +143°C, the device is enabled. The outputs pulsate as the temperature fluctuates between the thermal limits.

Shutdown

The MAX9706/MAX9707 feature a 0.1μA shutdown mode that reduces power consumption to extend battery life. Driving SHDN low disables the drive amplifiers, bias circuitry, and charge pump and sets the headphone amplifier output impedance to 1.4kΩ.

Applications Information

Filterless Class D Operation

Traditional Class D amplifiers require an output filter to recover the audio signal from the amplifier’s PWM output. The filters add cost, increase the solution size of the amplifier, and can decrease efficiency. The traditional PWM scheme uses large differential output swings (2 × V_{DD(P-P)}) and causes large ripple currents. Any parasitic resistance in the filter components results in a loss of power, lowering the efficiency.

The MAX9706/MAX9707 do not require an output filter. The devices rely on the inherent inductance of the speaker coil and the natural filtering of both the speaker and the human ear to recover the audio component of the square-wave output. Eliminating the output filter results in a smaller, less costly, more efficient solution.

Because the frequency of the MAX9706/MAX9707 output is well beyond the bandwidth of most speakers, voice coil movement due to the square-wave frequency is very small. Although this movement is small, a speaker not designed to handle the additional power can be damaged. For optimum results, use a speaker with a series inductance >10μH. Typical 8Ω speakers for portable audio applications exhibit series inductances in the 20μH to 100μH range.

3-Channel, 2.3W, Filterless Class D Amplifiers with Active Crossover

Power Supplies

The MAX9706/MAX9707 have different supplies for each portion of the devices, allowing for the optimum combination of headroom power dissipation and noise immunity. The speaker amplifiers are powered from PVDD. PVDD can range from 4.5V to 5.5V and must be connected to the same potential as VDD. The headphone amplifiers are powered from HPVDD and VSS. HPVDD is the positive supply of the headphone amplifiers and can range from 3V to 5.5V. VSS is the negative supply of the headphone amplifiers. Connect VSS to CPVSS. The charge pump is powered by CPVDD. Connect CPVDD to VDD for normal operation. The charge pump inverts the voltage at CPVDD, and the resulting voltage appears at CPVSS. The remainder of the device is powered by VDD.

Component Selection

Input Filter

An input capacitor, C_{IN}, in conjunction with the input impedance of the MAX9706/MAX9707 forms a high-pass filter that removes the DC bias from an incoming signal. The AC-coupling capacitor allows the amplifier to automatically bias the signal to an optimum DC level. Assuming zero-source impedance, the -3dB point of the highpass filter is given by:

$$f_{-3dB} = \frac{1}{2\pi \times R_{IN} \times C_{IN}}$$

Choose C_{IN} so f_{-3dB} is well below the lowest frequency of interest. Use capacitors whose dielectrics have low-voltage coefficients, such as tantalum or aluminum electrolytic. Capacitors with high-voltage coefficients, such as ceramics, may result in increased distortion at low frequencies.

Crossover Selection

Select the crossover filter to suit the chosen speaker. Many small diameter speakers (as used in notebooks and smaller displays) are self resonant (f₀) at 800Hz to 1000Hz. Often these speakers have a slight peaking at resonance, so choosing a crossover frequency at 2 × f₀ can be effective. Ensure the mono channel speaker has its f₀ much lower than crossover frequency (f_C).

Supply Bypassing, Layout, and Grounding

Proper layout and grounding are essential for optimum performance. Use large traces for the power-supply inputs and amplifier outputs to minimize losses due to parasitic trace resistance. Large traces also aid in moving heat away from the package. Proper grounding improves audio performance, minimizes crosstalk between channels, and prevents any switching noise from coupling into the audio signal. Connect PGND and GND together at a single point on the PC board (star configuration). Route all traces that carry switching transients away from GND and the traces/components in the audio signal path.

Connect the power-supply inputs VDD and PVDD together and connect CPVDD and HPVDD together. Bypass HPVDD and CPVDD with a 1μF capacitor in parallel with a 0.1μF capacitor to PGND. Bypass VDD and PVDD with a 1μF capacitor to GND. Place the bypass capacitors as close to the device as possible. Place a bulk capacitor between PVDD and PGND if needed.

Use large, low-resistance output traces. Current drawn from the outputs increase as load impedance decreases. High-output trace resistance decreases the power delivered to the load. Large output, supply, and GND traces allow more heat to move from the device to the air, decreasing the thermal impedance of the circuit if possible or connect to VSS.

The MAX9706/MAX9707 thin QFN-EP package features an exposed thermal pad on its underside. This pad lowers the package's thermal impedance by providing a direct heat conduction path from the die to the PC board. The exposed thermal pad is not internally connected. Connect the exposed pad to GND.

BIAS Capacitor

BIAS is the output of the internally generated DC bias voltage. The BIAS bypass capacitor, C_{BIAS} improves PSRR and THD+N by reducing power supply and other noise sources at the common-mode bias node, and also generates the clickless/popless, startup/shutdown DC bias waveforms for the speaker amplifiers. Bypass BIAS with a 1μF capacitor to GND.

3-Channel, 2.3W, Filterless Class D Amplifiers with Active Crossover

MAX9706/MAX9707

Table 5. Suggested Capacitor Manufacturers

SUPPLIER	PHONE	FAX	WEBSITE
Taiyo Yuden	800-348-2496	847-925-0899	www.t-yuden.com
TDK	807-803-6100	847-390-4405	www.component.tdk.com

Charge-Pump Capacitor Selection (MAX9706)

Use capacitors with an ESR less than 100mΩ for optimum performance. Low-ESR ceramic capacitors minimize the output resistance of the charge pump. Most surface-mount ceramic capacitors satisfy the ESR requirement. For best performance over the extended temperature range, select capacitors with an X7R dielectric. Table 5 lists suggested manufacturers.

Flying Capacitor (C1, MAX9706)

The value of the flying capacitor (C1) affects the output resistance of the charge pump. A C1 value that is too small degrades the device's ability to provide sufficient current drive, which leads to a loss of output voltage. Increasing the value of C1 reduces the charge-pump output resistance to an extent. Above 1μF, the on-resistance of the switches and the ESR of C1 and C2 dominate.

Output Capacitor (C2, MAX9706)

The output capacitor value and ESR directly affect the ripple at CPV_{SS}. Increasing the value of C2 reduces output ripple. Likewise, decreasing the ESR of C2 reduces both ripple and output resistance. Lower capacitance values can be used in systems with low maximum output power levels. See the Output Power vs. Charge-Pump Capacitance and Load Resistance graph in the *Typical Operating Characteristics*. C2 must be equal to or greater than C1.

CPV_{DD} Bypass Capacitor (MAX9706)

The CPV_{DD} bypass capacitor lowers the output impedance of the power supply and reduces the impact of the MAX9706's charge-pump switching transients. Bypass CPV_{DD} with a capacitor to CPGND and place it physically close to CPV_{DD} and CPGND. Use a value that is equal to C1.

3-Channel, 2.3W, Filterless Class D Amplifiers with Active Crossover

Functional Diagram/Typical Operating Circuits

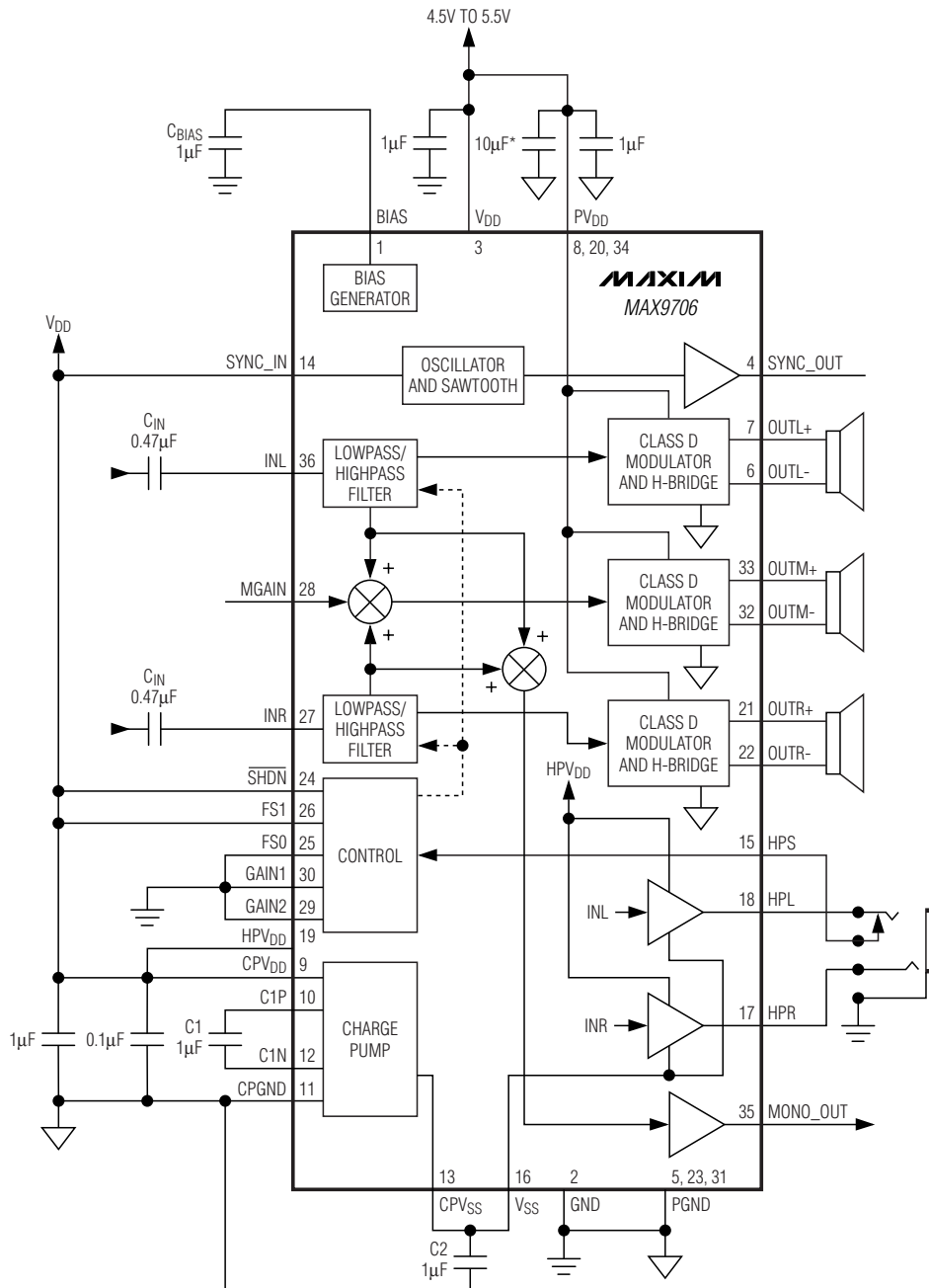

*BULK CAPACITANCE IF NEEDED
 TYPICAL OPERATING CIRCUIT SHOWN DEPICTS THE MAX9706 WITH:
 SSM MODE WITH $f_{OSC} = 1150\text{kHz}$, SPEAKER GAIN = +9dB, MONO SPEAKER GAIN OFFSET = -6.0dB,
 HEADPHONE SPEAKER GAIN = +0dB, AND CROSSOVER FREQUENCY = 1066.7Hz.

3-Channel, 2.3W, Filterless Class D Amplifiers with Active Crossover

Functional Diagram/Typical Operating Circuits (continued)

MAX9706/MAX9707

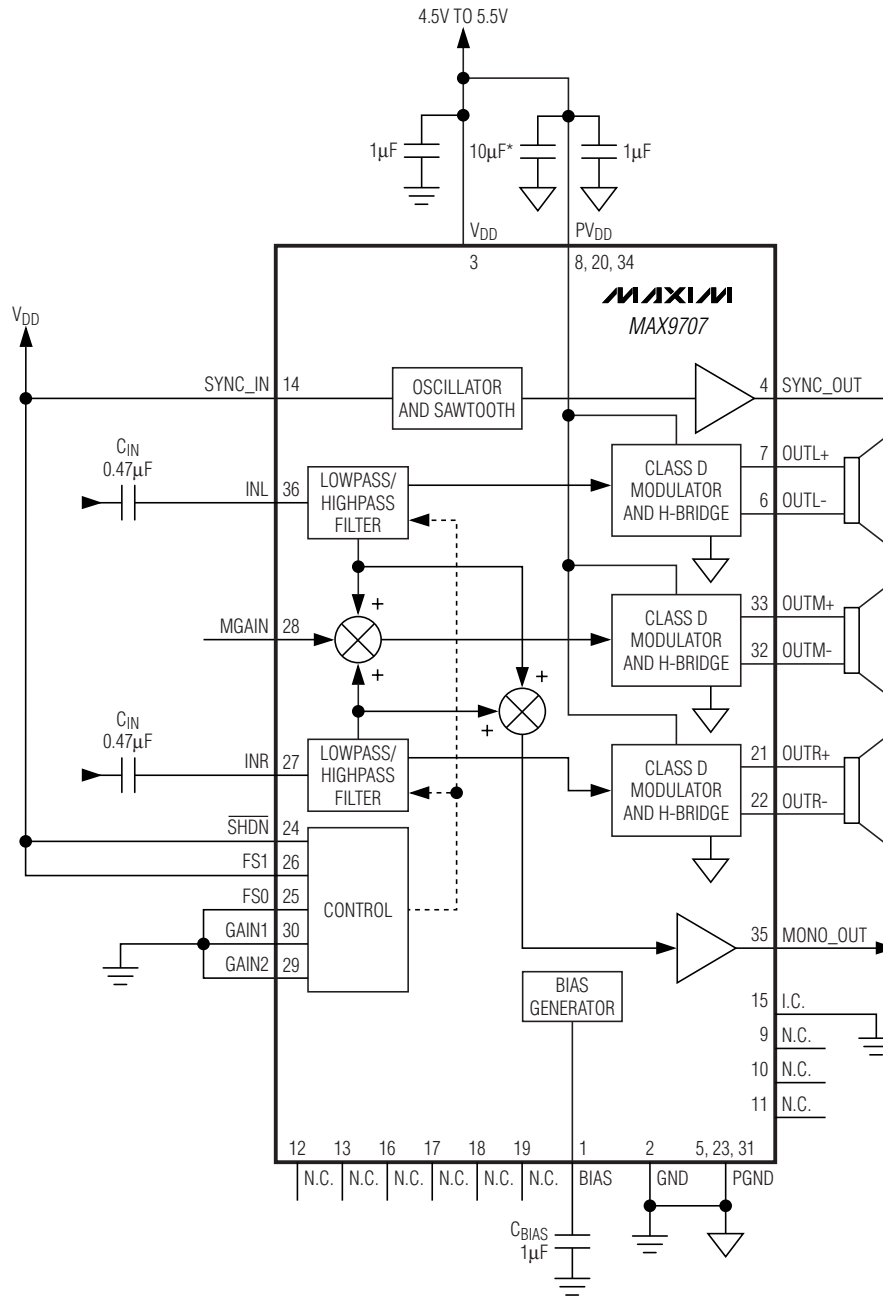

*BULK CAPACITANCE IF NEEDED
 TYPICAL OPERATING CIRCUIT SHOWN DEPICTS THE MAX9707 WITH:
 SSM MODE WITH $f_{OSC} = 1150\text{kHz}$, SPEAKER GAIN = +9dB, MONO SPEAKER GAIN OFFSET = -6.0dB,
 AND CROSSOVER FREQUENCY = 1066.7Hz.

3-Channel, 2.3W, Filterless Class D Amplifiers with Active Crossover

Pin Configurations

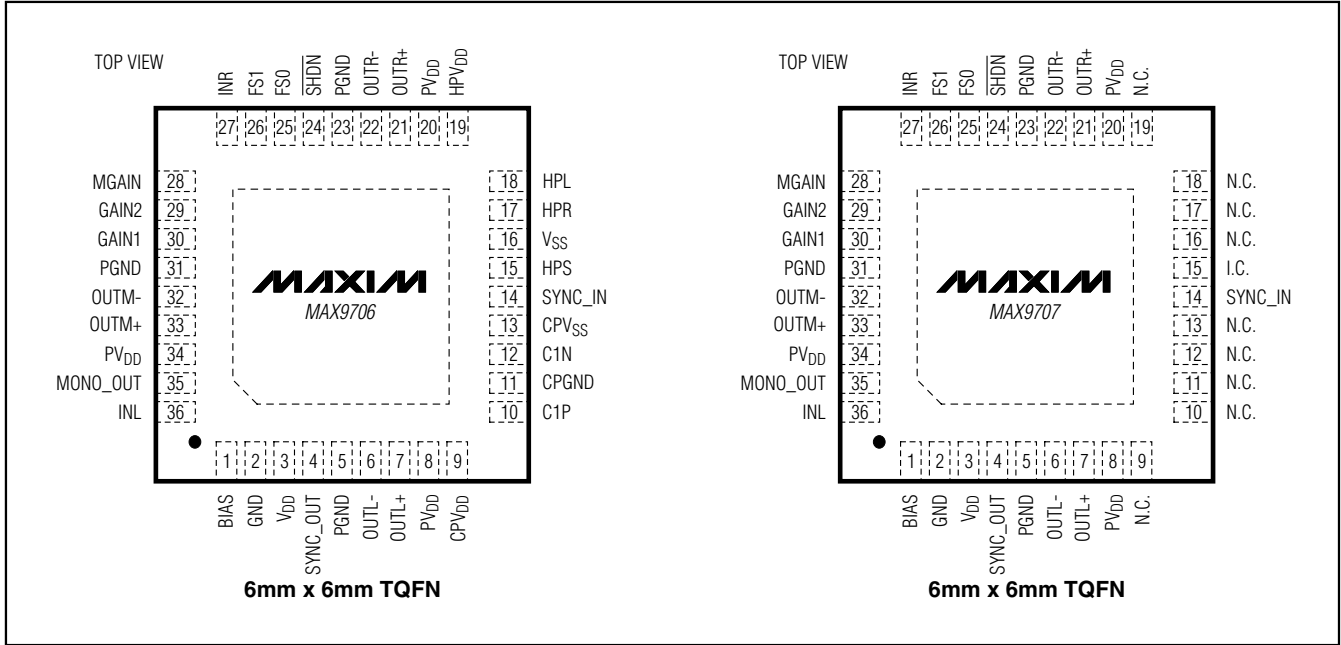

Chip Information

TRANSISTOR COUNT: 12,686

PROCESS: BICMOS

3-Channel, 2.3W, Filterless Class D Amplifiers with Active Crossover

Package Information

(The package drawing(s) in this data sheet may not reflect the most current specifications. For the latest package outline information, go to www.maxim-ic.com/packages.)

MAX9706/MAX9707

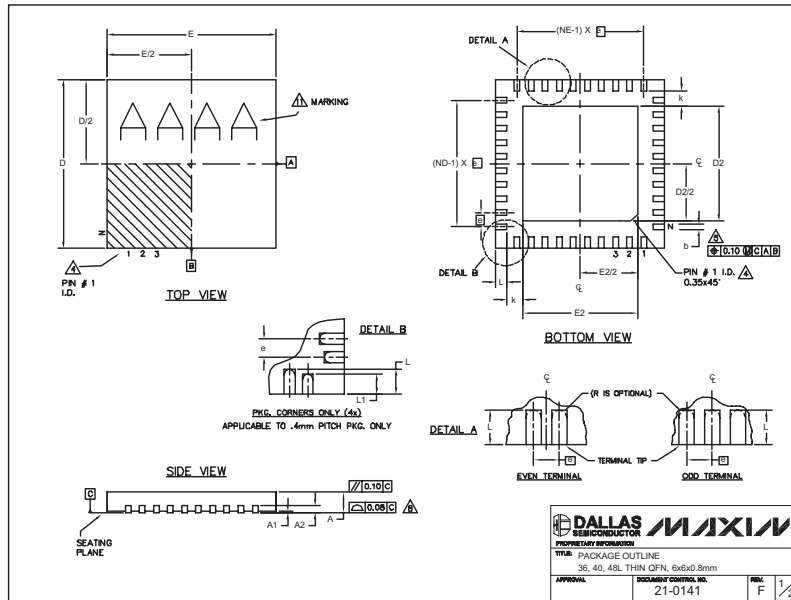

COMMON DIMENSIONS									
PKG.	36L 6x6			40L 6x6			48L 6x6		
SYMBOL	MIN.	NOM.	MAX.	MIN.	NOM.	MAX.	MIN.	NOM.	MAX.
A	0.70	0.75	0.80	0.70	0.75	0.80	0.70	0.75	0.80
A1	0	0.02	0.05	0	0.02	0.05	0	0	0.05
A2	0.20 REF.			0.20 REF.			0.20 REF.		
b	0.20	0.25	0.30	0.20	0.25	0.30	0.15	0.20	0.25
D	5.90	6.00	6.10	5.90	6.00	6.10	5.90	6.00	6.10
E	5.90	6.00	6.10	5.90	6.00	6.10	5.90	6.00	6.10
e	0.50 BSC.			0.50 BSC.			0.40 BSC.		
k	0.25	-	-	0.25	-	-	0.25	0.35	0.45
L	0.45	0.55	0.65	0.30	0.40	0.50	0.40	0.50	0.60
L1	-	-	-	-	-	-	0.30	0.40	0.50
N	36			40			48		
ND	9			10			12		
NE	9			10			12		
JEDEC	WJ0-1			WJ0-2			-		

EXPOSED PAD VARIATIONS						DOWN BONDS ALLOWED	
PKG. CODES	D2			E2			
	MIN.	NOM.	MAX.	MIN.	NOM.	MAX.	
T3666-2	3.80	3.70	3.80	3.60	3.70	3.80	YES
T3666-3	3.80	3.70	3.80	3.60	3.70	3.80	NO
T3668N-1	3.60	3.70	3.80	3.60	3.70	3.80	NO
T4066-2	4.00	4.10	4.20	4.00	4.10	4.20	YES
T4066-3	4.00	4.10	4.20	4.00	4.10	4.20	YES
T4066-4	4.00	4.10	4.20	4.00	4.10	4.20	NO
T4066-5	4.00	4.10	4.20	4.00	4.10	4.20	NO
T4866-1	4.20	4.30	4.40	4.20	4.30	4.40	YES

NOTES:

- DIMENSIONING & TOLERANCING CONFORM TO ASME Y14.5M-1994.
- ALL DIMENSIONS ARE IN MILLIMETERS. ANGLES ARE IN DEGREES.
- N IS THE TOTAL NUMBER OF TERMINALS.
- THE TERMINAL #1 IDENTIFIER AND TERMINAL NUMBERING CONVENTION SHALL CONFORM TO JESD 95-1 SPP-012. DETAILS OF TERMINAL #1 IDENTIFIER ARE OPTIONAL, BUT MUST BE LOCATED WITHIN THE ZONE INDICATED. THE TERMINAL #1 IDENTIFIER MAY BE EITHER A MOLD OR MARKED FEATURE.
- MARKING IS FOR PACKAGE ORIENTATION REFERENCE ONLY.
- DEPOPULATION IS POSSIBLE IN A SYMMETRICAL FASHION.
- COPLANARITY APPLIES TO THE EXPOSED HEAT SINK SLUG AS WELL AS THE TERMINALS.
- DRAWING CONFORMS TO JEDEC MO220, EXCEPT FOR 0.4mm LEAD PITCH PACKAGE T4866-1.
- WARPAGE SHALL NOT EXCEED 0.10 mm.
- MARKING IS FOR PACKAGE ORIENTATION REFERENCE ONLY.
- NUMBER OF LEADS SHOWN FOR REFERENCE ONLY.

The MAX9706/MAX9707 Thin QFN-EP package features an exposed thermal pad on its underside. This pad lowers the package's thermal impedance by providing a direct heat conduction path from the die to the printed circuit board. The exposed thermal pad is not internally connected. Connect the exposed pad to GND.

Maxim cannot assume responsibility for use of any circuitry other than circuitry entirely embodied in a Maxim product. No circuit patent licenses are implied. Maxim reserves the right to change the circuitry and specifications without notice at any time.

Maxim Integrated Products, 120 San Gabriel Drive, Sunnyvale, CA 94086 408-737-7600 25