

# SMD Power Inductor CDRH8D43

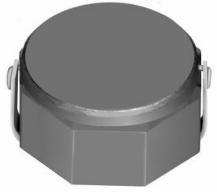
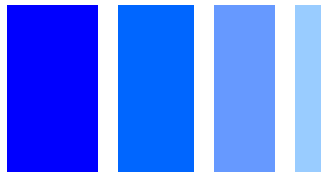

## Description

- Ferrite drum core construction.
- Magnetically shielded.
- L × W × H: 8.3 × 8.3 × 4.5 mm Max.
- Product weight: 0.93g(Ref.)
- Moisture Sensitivity Level: 1
- RoHS compliance.

## Environmental Data

- Operating temperature range: -40°C ~ +100°C (including coil's self temperature rise)
- Storage temperature range: -40°C ~ +100°C
- Solder reflow temperature: 260 °C peak.

## Packaging

- Carrier tape and reel packaging
- 13" diameter reel
- 500pcs per reel

## Applications

- Ideally used in Mobile phone, MP3, PDA , HDD, DSC/DVC, etc as DC-DC converter inductors.

## Dimension - [mm]

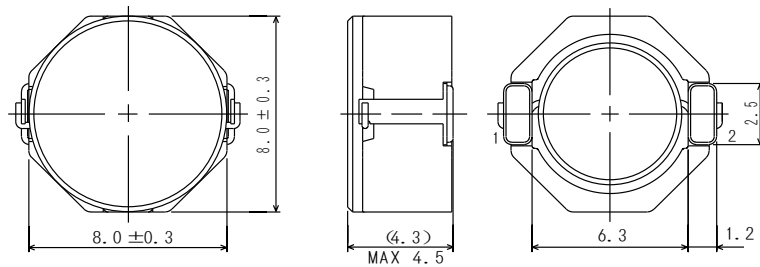

## Land pattern and Schematics - [mm]

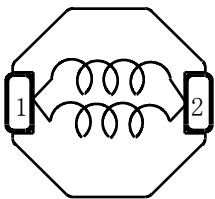
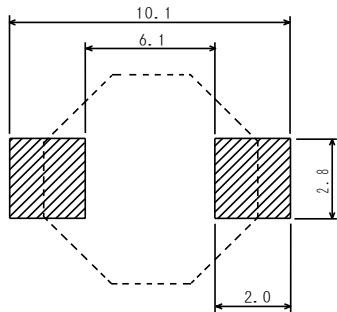

(0.68μH ~ 15μH)

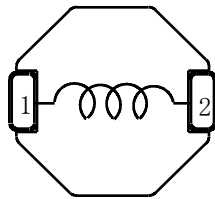

(22μH ~ 100μH)

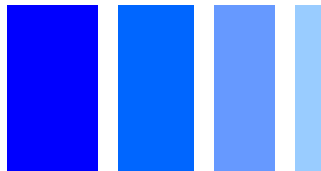

## Electrical Characteristics

Part Name	Stamp	Inductance ( $\mu\text{H}$ ) [ within ] ※1	D.C.R. ( $\text{m}\Omega$ ) Max. (Typ.) (at 20°C)	Saturation Current (A) ※2	Temperature Rise Current (A) ※3
CDRH8D43NP-R68NC	R68	$0.68 \pm 35\%$	9.5(7.0)	9.0	6.9
CDRH8D43NP-1R2NC	1R2	$1.2 \pm 35\%$	12.2(9.0)	8.0	6.2
CDRH8D43NP-2R0NC	2R0	$2.0 \pm 30\%$	14(11)	7.0	5.5
CDRH8D43NP-3R9NC	3R9	$3.9 \pm 30\%$	19(15)	5.9	4.5
CDRH8D43NP-4R7NC	4R7	$4.7 \pm 30\%$	22(17)	5.6	4.1
CDRH8D43NP-6R8NC	6R8	$6.8 \pm 30\%$	25(20)	4.4	3.9
CDRH8D43NP-100NC	100	$10 \pm 30\%$	36(29)	4.0	3.2
CDRH8D43NP-150NC	150	$15 \pm 30\%$	53(42)	2.9	2.3
CDRH8D43NP-220NC	220	$22 \pm 30\%$	75(60)	2.6	1.8
CDRH8D43NP-330NC	330	$33 \pm 30\%$	125(100)	2.2	1.4
CDRH8D43NP-470NC	470	$47 \pm 30\%$	150(120)	1.8	1.3
CDRH8D43NP-680NC	680	$68 \pm 30\%$	240(190)	1.5	1.0
CDRH8D43NP-101NC	101	$100 \pm 30\%$	360(290)	1.3	0.8

※1. Inductance measuring conditions at 100kHz.

※2. Saturation current: The DC current at which the inductance decreases to 65% of its nominal value.

※3. Temperature rise current: The DC current at which the temperature rise is  $\Delta t = 40^\circ\text{C}$ . ( $T_a = 20^\circ\text{C}$ )

# SMD Power Inductor CDRH8D43



## Saturation Current & Temperature Rise Graph

— L (20°C) — L (100°C) —  $\Delta T$

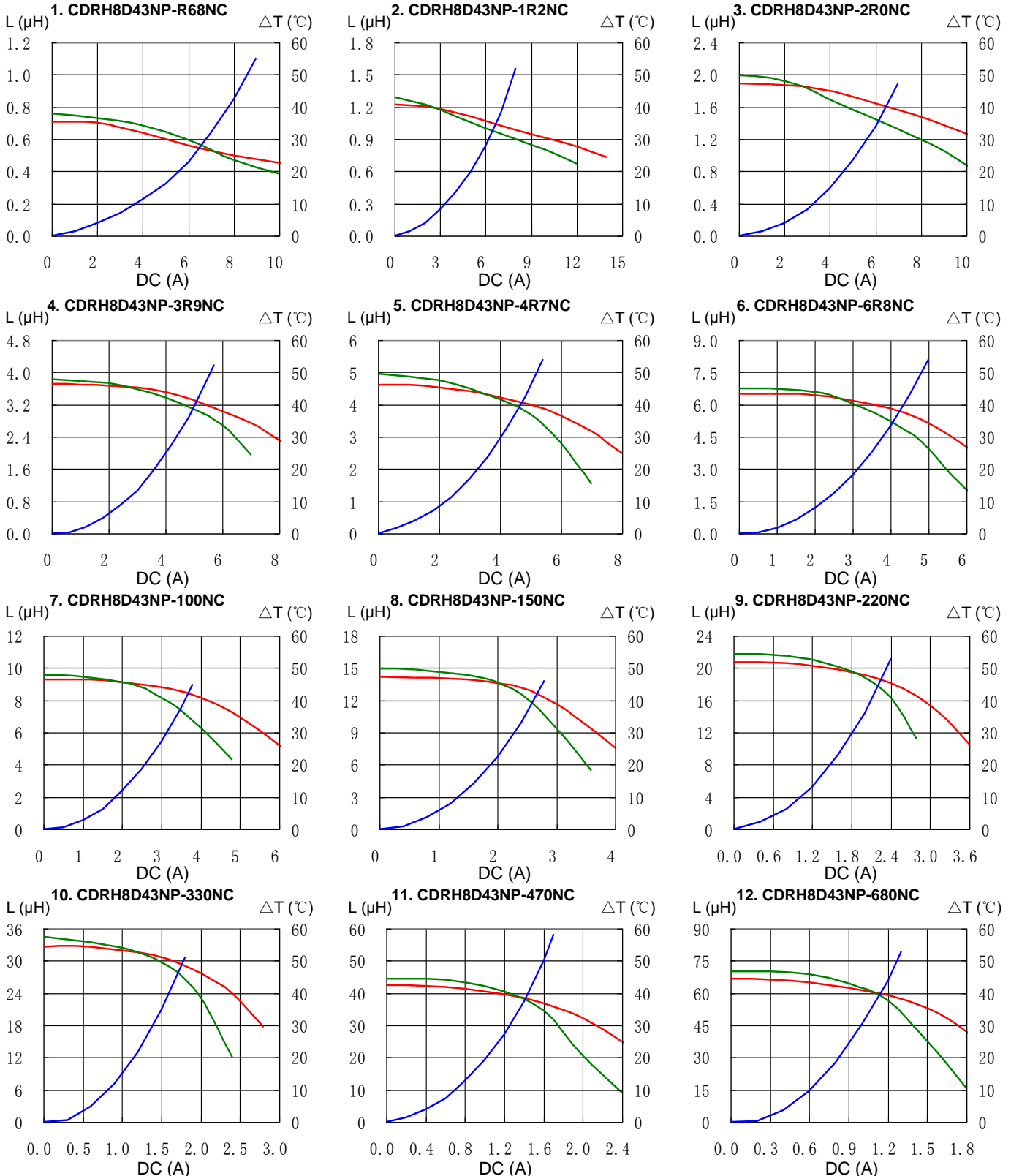

# SMD Power Inductor CDRH8D43

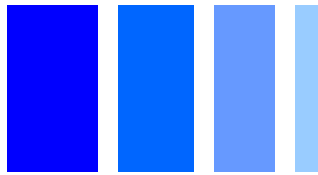

## Saturation Current & Temperature Rise Graph

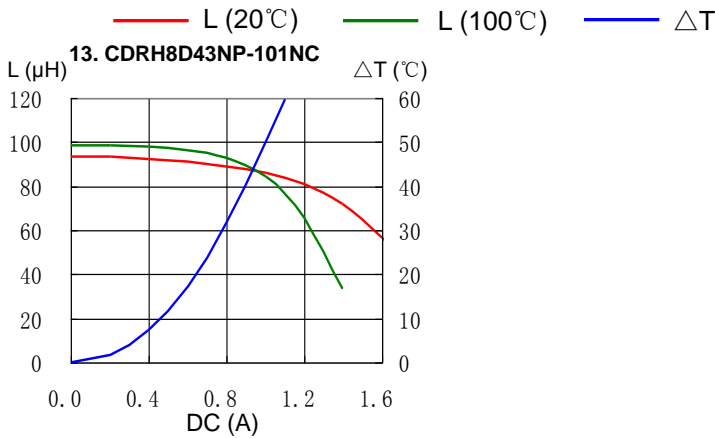

## Solder Reflow Condition

Heat Endurance

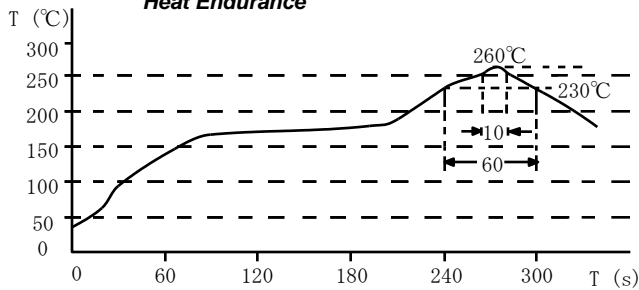

Temperature Chart

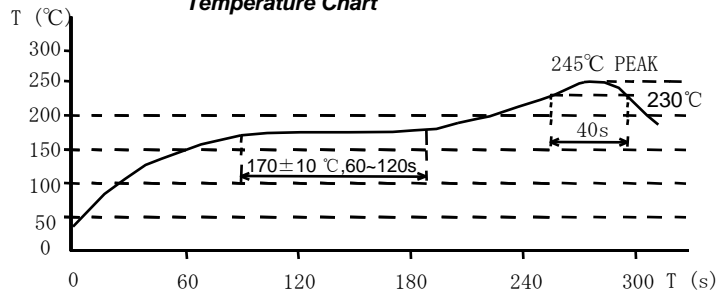

Please refer to the sales offices on our website - <http://www.sumida.com>

### Hong Kong

Tel. +852-2880-6781  
FAX. +852-2565-9600  
[sales@hk.sumida.com](mailto:sales@hk.sumida.com)

### Saitama(Japan)

Tel. +81-48-691-7300  
FAX. +81-48-691-7340  
[sales@jp.sumida.com](mailto:sales@jp.sumida.com)

### Chicago

Tel. +1-847-545-6700  
FAX. +1-847-545-6720  
[sales@us.sumida.com](mailto:sales@us.sumida.com)

### Shanghai

Tel. +86-21-5836-3299  
FAX. +86-21-5836-3266  
[shanghai.sales@cn.sumida.com](mailto:shanghai.sales@cn.sumida.com)

### Seoul

Tel. +82-2-6237-0777  
FAX. +82-2-6237-0778  
[sales@kr.sumida.com](mailto:sales@kr.sumida.com)

### Obernzell

Tel. +49-8591-937-0  
FAX. +49-8591-937-103  
[contact@eu.sumida.com](mailto:contact@eu.sumida.com)

### Shenzhen

Tel. +86-755-8291-0228  
FAX. +86-755-8291-0338  
[shenzhen.sales@cn.sumida.com](mailto:shenzhen.sales@cn.sumida.com)

### Singapore

Tel. +65-6296-3388  
FAX. +65-6841-4426  
[sales@sg.sumida.com](mailto:sales@sg.sumida.com)

### Neumarkt

Tel. +49-9181-4509-110  
FAX. +49-9181-4509-310  
[infocomp@eu.sumida.com](mailto:infocomp@eu.sumida.com)

### Taipei

Tel. +886-2-8751-2737  
FAX. +886-2-8751-2738  
[sales@tw.sumida.com](mailto:sales@tw.sumida.com)

### San Jose

Tel. +1-408-321-9660  
FAX. +1-408-321-9308  
[sales@us.sumida.com](mailto:sales@us.sumida.com)