



# NFC for embedded applications

Your critical link for the Internet of Things



# NFC—your critical link for the Internet of Things



Experts predict an explosion of connected “things” to occur over the next few years. As more things get connected, concerns over data privacy and security will escalate. Utilizing Near Field Communication (NFC) as a communication method can help address some of these concerns.

## NFC is the critical link

According to market research, soon more users will access the Internet wirelessly via mobile devices than from wired Ethernet connections. These mobile devices offer several different wireless connectivity options, each with their different strengths and capabilities. But only NFC is specifically designed and engineered

to provide zero power operation and maximize privacy, both at a very low cost.

## Privacy

NFC by design has a limited field of operation, which prevents data snooping that could occur from a distance. It also requires intent—the application of an NFC-enabled device to an NFC-enabled object—in order to read its memory. This approach is in contrast to protocols such as WiFi, which require radios to broadcast information regardless of intent. The limited field plus other features of the protocol help to ensure that data exchange only occurs with the intended party.

### Low power

When communicating between an NFC reader and an NFC transponder (tag), energy harvested from the RF field of the reader powers the tag, enabling connectivity for Internet of Things (IoT) devices without using batteries or power. This energy harvesting feature enables a number of low-power and low-cost applications.

### Low cost



























Adding a connected NFC tag to an embedded system can establish connectivity to mobile devices at much lower cost than Bluetooth or WiFi

approaches. In addition, eliminating the need for a battery in an embedded system can further lower an application’s overall bill of materials.

### Comparing wireless protocols

Designers have several choices for connectivity, all with trade-offs (see Table 1). WiFi, ZigBee, and Bluetooth all have different strengths and capabilities. None, however, were specifically defined and engineered to provide zero-power operation and maximize privacy, and do both at very low cost, as NFC does.

Table 1 Wireless connectivity tradeoffs

	 WiFi	 ZigBee (802.15.4)	 Bluetooth	 NFC
Network topology	 Star	 Mesh	 Point-to-point	 Point-to-point
Range	 30-100 m	 10-20 m	 10 m	 < 0.1 m
Discovery	 Broadcast	 Broadcast	 Broadcast	 Response to field
Power	 High	 Low	 Classic: Mid  LE/Smart: Low	 Tag: Zero  Reader: Very low
Privacy	 Low	 Mid	 Mid	 High

# NFC principles of operation

## Overview

Near Field Communication (NFC) is a short-range, wireless connectivity technology designed to be intuitive. NFC enables simplified transactions, data exchange, pairing, wireless connections, and convenience between two objects when in close proximity to one another (up to 10 cm apart). Because the communication is one-to-one and requires such close proximity, data privacy is more inherent than with other wireless approaches.

NFC has three communication modes: Read/Write, Peer-to-Peer, and Card Emulation.

## Read/Write mode

In Read/Write mode, an NFC reader/writer (or NFC-enabled mobile phone acting as a traditional contactless reader/writer) reads data from NFC-enabled smart objects and acts upon that information. With an NFC-enabled phone, for example, users can automatically connect to websites via a retrieved URL, send short message service (SMS) texts without typing, obtain coupons, etc., all with only a touch of their device to the object.

## Peer-to-Peer mode

In Peer-to-Peer mode, any NFC-enabled reader/writer can communicate to another NFC reader/writer to exchange data with the same advantages of safety, security, intuitiveness, and simplicity inherent in Read/Write mode. In Peer-to-Peer mode, one of the reader/writers behaves as a tag, creating a communication link. For example, two devices (such as smartphones) with readers/writers can communicate with each other.

## Card Emulation mode

An NFC device in Card Emulation mode can replace a contactless smartcard, enabling use of NFC-enabled devices within the existing contactless card infrastructure for operations such as ticketing, access control, transit, tollgates, and contactless payments. NXP has broad product offerings to support the secure transactions necessary for this mode.



Figure 1. The three modes of NFC communication

### NFC Read/Write mode for embedded systems

Most embedded applications that utilize NFC will use Read/Write mode for the link. In these cases, an NFC-enabled device, such as a mobile device, will provide the active reader, and the tag will be in the embedded system.

Functionally, a connected NFC tag in an embedded system behaves similarly to a dual port memory. One of the memory ports is accessed wirelessly through an NFC interface. The other port is accessed by the embedded system via an I<sup>2</sup>C interface.

Through this functionality, data can pass from an external source (e.g., an NFC-enabled mobile device) to the embedded system. Furthermore, because NFC connected tags are passive, they can be read from, or written to, by the external source even when the embedded system is powered off.

Because NFC connected tags function similarly to dual port memories, they facilitate any application that requires data transfer between an embedded system and an external system with an NFC reader/writer, such as an NFC-enabled mobile device.

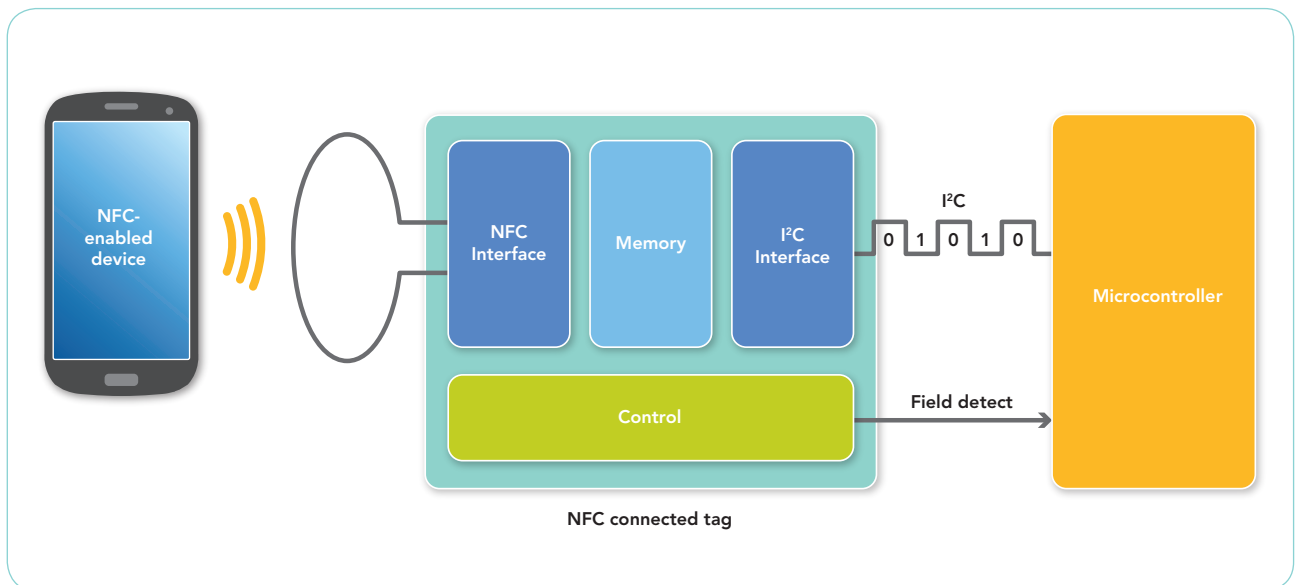

Figure 2. NFC connected tag block diagram

# Cost-effective, enhanced user experience with NFC

For any product where adding an elaborate touch display for extended product features and remote control capability would ruin the aesthetics, add unwelcome cost to the bill of materials, or just simply not fit, NXP's NTAG I<sup>2</sup>C chip provides the ideal solution. Using a dual port NTAG I<sup>2</sup>C chip to provide the conduit between an embedded system's microcontroller and a user's NFC-enabled reader/writer device (e.g., phone) allows that device to become an extended graphical display and touch screen user interface for the system.

## Benefits

- ▶ Removes the cost of a fancy touch display from a product's bill of materials, replacing it with a much more cost-effective NTAG I<sup>2</sup>C tag chip
- ▶ Eliminates the cost of a Bluetooth or WiFi interface
- ▶ Simplifies product design (eliminates need for external buttons and dials) and lowers cost
- ▶ Enhances security (unauthorized control of products not as accessible)
- ▶ Consumer intent-driven wireless connectivity addresses privacy concerns

## HOW IT WORKS

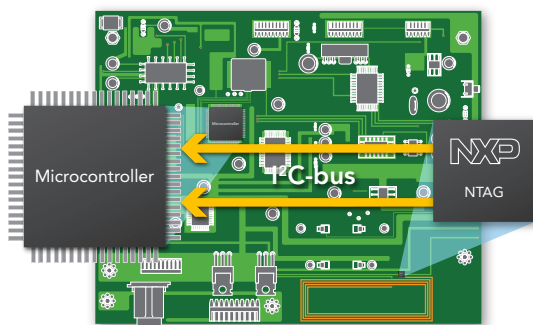

↑  
The NTAG I<sup>2</sup>C tag IC connects to the product's microcontroller via the I<sup>2</sup>C serial bus interface

↑  
The NFC tag IC can be a self-contained module or integrated into the PCB



↑  
A user's NFC-enabled mobile device connects to the product via the NFC interface, using the NTAG I<sup>2</sup>C as the communication conduit

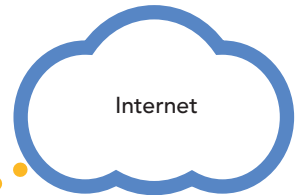

← The already available, advanced graphic display and touch screen of the NFC-enabled mobile device provides extended interface and control options to the product.

## Application examples



### Appliances (White Goods)

Home appliances, such as washing machines, are products where aesthetics are important, size is standardized, and gross margins are moderate. Users want form and function, they like special features, but desire easy operation. The NFC connected tag is a cost-effective way in which a manufacturer can create one product case to house multiple product variants. Communication with the washing machine is as simple as opening an application on an NFC-enabled mobile device, and tapping that device to the machine control panel. All extended settings become available in one convenient location.



### Fitness Tracking Wearable

Fitness tracking bracelets help users set fitness goals and track progress against their goals. By definition, wearable devices must be small, aesthetically pleasing, and easily rechargeable. Displays are limited, and direct control of small wearable devices via tiny mechanical buttons can be difficult. Adding an NFC connected tag chip to the electronics inside a fitness band provides access to a much richer user experience. Touching their phone to the band opens up a user display where users input their goals easily, view their progress, and control backup or upload to the cloud. And, the close proximity requirement of NFC communication protects the user's private data against unauthorized access by others in the vicinity.



### Smart Meter Access

As "Smart Meters" for utility usage tracking become more prevalent, utility companies don't need to read usage data directly from a meter, so the mechanical or digital readouts are primarily for the user's information. With an embedded NFC connected tag chip as part of the smart meter design, NFC communication can extend the on-meter displays, and provide additional information for an enriched user experience. (For example, users could access historical usage profiles or graphs in between monthly billing updates.)

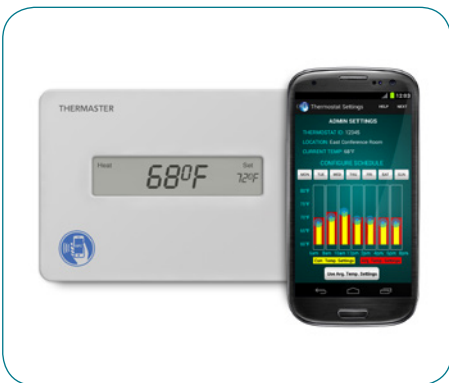

### Thermostat Control

Thermostat controller interfaces in commercial settings represent a facilities challenge. To conserve energy and support greater efficiency, most facility managers prefer to keep temperatures within a common, narrow range. Yet sometimes certain rooms are too hot or too cold for comfort. Plus, controls can be confusing, hard to see, difficult to manipulate, or caged behind a mechanical lock box. With an embedded NFC connected tag chip, the control interface becomes a sleek unit with an easy-to-read temperature display. Users tap their NFC-enabled mobile devices to the surface and use the graphical interface for temperature adjustments, daily schedule control, or other extended feature access.

### Administrative access to electronic devices

Embedding an NFC connected tag chip into electronic products facilitates controlled access. Users with an NFC-enabled mobile device initiate communication via the NFC interface. Microcontroller software limits access to those with appropriate credentials.

#### Benefits

- ▶ Removes the cost of external access control measures, such as mechanical enclosures
- ▶ Adds convenience, especially when combined with the extended graphical user interface available on any NFC-enabled mobile device
- ▶ Simplifies product design (eliminates need for external buttons and dials)
- ▶ Increases access flexibility (remotely granted access possible)
- ▶ Enhances security (unauthorized control of products not as accessible)



Figure 3. Controlled access to thermostat settings

### Self-serve maintenance

When an embedded system includes an NFC-connected tag, the system controller can use the internal, nonvolatile memory of the tag to store data such as error codes, serial and model numbers, and warranty information. Power to the electronic product is not necessary in order to retrieve data from the tag memory via an NFC-enabled mobile device. Links stored in memory can even launch instructional videos on a mobile device for enhanced consumer convenience.

#### Benefits

- ▶ Saves time and money
- ▶ Adds convenience, as consumers have greater control at their fingertips
- ▶ Reduces new product paper documentation, creating a more ecologically friendly approach
- ▶ Cloud-enabled applications on the mobile device provide context-specific information in response to the information retrieved from the tag
- ▶ Enhances security (have to be within a limited range to retrieve information)

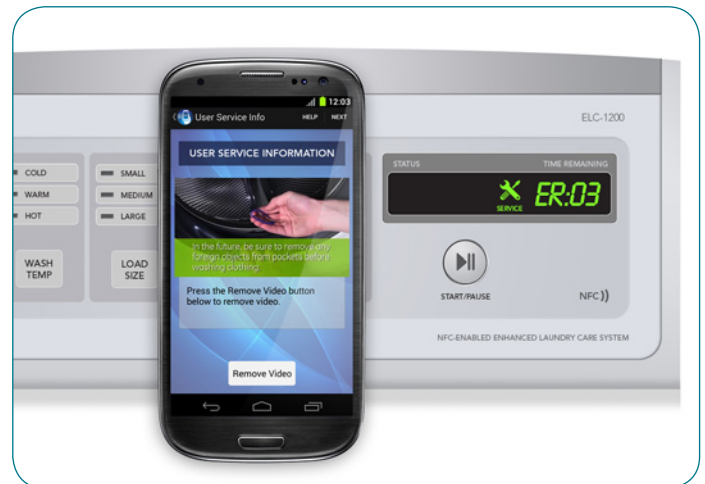

Figure 4. Appliance error code can send user to a Web site for additional information



## Firmware update

Any product requiring firmware or data updates benefits from the inclusion of an NFC connected tag chip, because it enables data download capability. The on-chip SRAM permits temporary storage of data during the transfer, enabling the tag chip to act as a modem.

### Benefits

- ▶ Adds convenience, as consumers don't need cables, disks, or other means of data transfer
- ▶ Saves bill of material costs for those products that wouldn't normally require a WiFi or Bluetooth interface for their typical operation
- ▶ Simplifies designs and improves their aesthetics, because external connectors are unnecessary
- ▶ Increases access flexibility (the contactless interface supports sealed designs)
- ▶ Enhances security (have to be within a limited proximity to download information)

## Warranty registration

Including an NFC connected tag chip in a product facilitates quick warranty registration through a consumer's NFC-enabled phone, where contact information is already available. Because the user's NFC-enabled mobile device already contains their contact information as part of their stored data, filling out a form is a one-step process. The necessary product information (such as serial number, model number, etc.) is readily available in the NFC tag memory. The paired user and product information gets stored in the product to facilitate later access, and also transfers to the cloud for the manufacturer's records via the mobile device's cellular or WiFi connection.

### Benefits

- ▶ Increases likelihood of consumers completing warranty registration, now estimated at about 25-30% return rate
- ▶ Removes cost of processing paper warranty cards
- ▶ Provides avenue to promote linked products, such as authentic consumable replenishments, creating a new revenue stream



Figure 5. An NFC-enabled device facilitates appliance firmware updates and data delivery

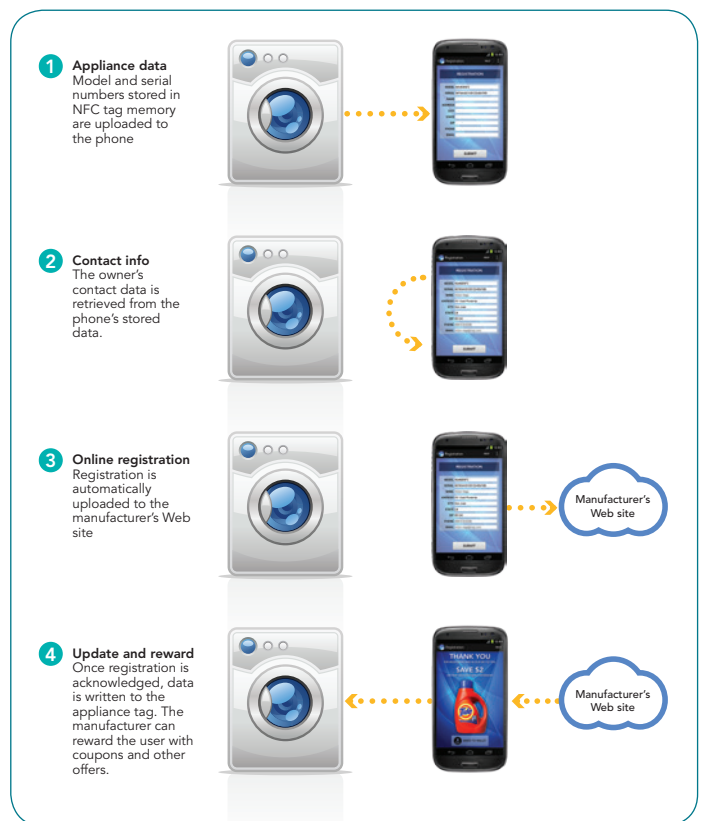

Figure 6. One-step warranty registration using an NFC-enabled device

# Wireless pairing and network commissioning

NFC makes wireless pairing and commissioning as easy as tapping an NFC reader/writer against the devices to be connected. An NFC reader/writer can operate as a network credential manager, retrieving credentials from programmed devices and writing those credentials to others to facilitate network connection. Or, an NFC-enabled device can connect itself to a network, by passing access codes to a programmed device for verification. In this case, it operates as both a network node and the network credential manager simultaneously.

## Benefits

- ▶ Proximity required by NFC offers increased security over longer range, or open credential transmission approaches
- ▶ User intent-driven approach provides consumers greater control
- ▶ One-touch approach offers convenience and time savings

## HOW IT WORKS

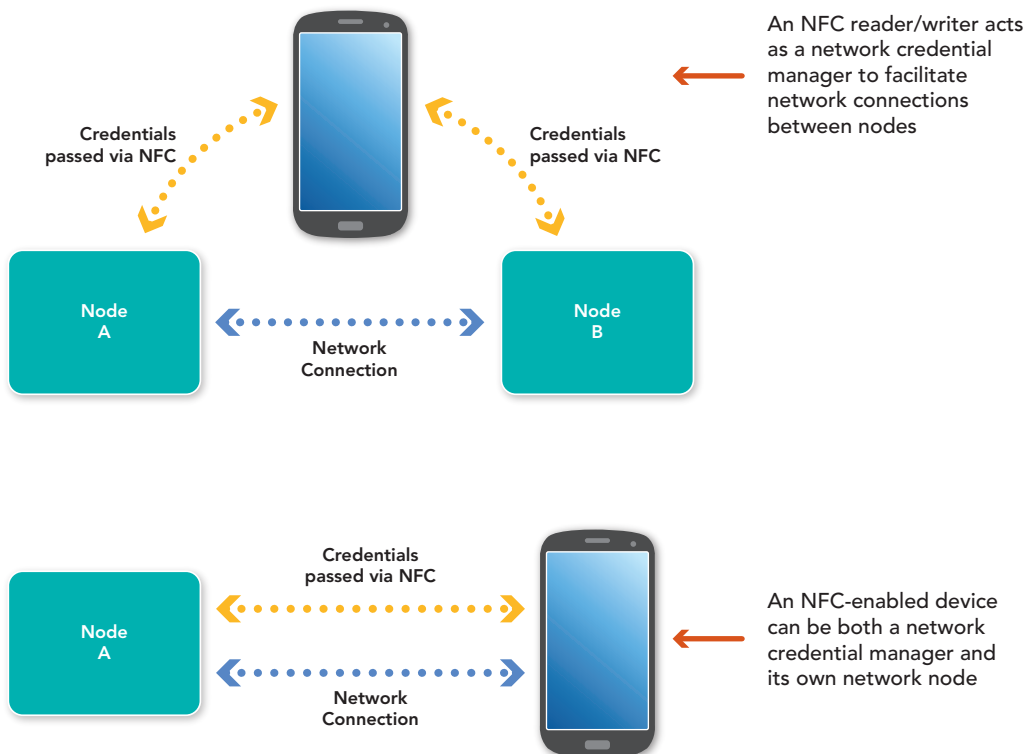

### Bluetooth pairing

Including NFC capability in Bluetooth designs brings tremendous convenience to consumers by localizing the Bluetooth passcode management function into an NFC-enabled reader/writer.

#### Benefits

- ▶ Eliminates the typical pairing steps of searching for Bluetooth devices, manually adding the device once found, and entering passcodes
- ▶ Enhances the customer experience
- ▶ Auto power up from deep sleep
- ▶ Offers increased security (NFC proximity for commissioning versus longer range wireless protocols)



Figure 7. One-tap from an NFC-enabled device simplifies Bluetooth pairing

### WiFi pairing

Rather than typing in passwords, providing credentials to enable access to a secured WiFi network is as easy as tapping an NFC-enabled device to the router. Transfer of credentials for network extenders requires only one tap against the router to retrieve, and one tap against an extender to program.

#### Benefits

- ▶ NFC-enabled devices connect by one-tap against the router
- ▶ Offers increased security (NFC proximity versus longer range wireless credential broadcast protocols)
- ▶ Provides consumer convenience



Figure 8. An NFC-enabled device passes network credentials to WiFi routers

### Home automation commissioning

Commission home automation networks more easily through NFC-enabled devices. Users tap NFC-enabled mobile phones on gateways and collect network parameters, which they then pass on to home automation items, creating smart devices.

#### Benefits

- ▶ Fast, accurate commissioning saves time
- ▶ Convenience to consumer is a key selling point



Figure 9. Tap a home automation item to quickly program it as a smart device

# Zero power configuration

An NFC tag embedded into a PCB and connected to the board electronic circuitry via a hardwired serial bus provides a permanent, contactless bridge between the product's MCU and the outside world. The passive (no power required) operation of NFC tags allows reading/writing of data from/to tag memory via the wireless interface even if the device has no power.

## Benefits

- ▶ NFC tag's nonvolatile memory stores configuration data and maintains it without power
- ▶ The NFC tag data is accessible via the wireless interface without disassembling products, or even removing them from their packaging

## HOW IT WORKS



### Product validation, customization and configuration

Data is written to the NTAG memory via the NFC communication interface whether the product is powered or not. Validation, customization, and configuration can occur during manufacturing or point-of-sale.



The NTAG memory is accessible to external reader/writers—even if the product is within a sealed box and without power

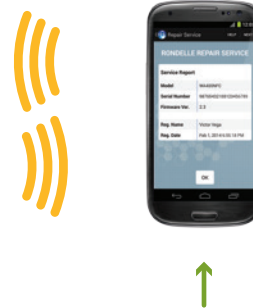

### Product servicing and return logistics

For service technicians, retrieving previously stored data provides accurate repair history and diagnostics. Return and repair centers can virtually peek inside boxed or sealed products.

## Use cases

### Product validation

Manufacturers can deactivate electronic products via the NFC interface in the factory, with activation only possible upon authentication at the point of sale. For returns, an NFC-enabled product provides a means of accessing identifying information that validates product authenticity.

#### Benefits

- ▶ Provides a cost efficient means of deterring counterfeiting, grey market diversion, and distribution channel theft
- ▶ Protects brands by decreasing chances of consumers unwittingly buying counterfeit goods
- ▶ Reduces fraudulent returns to the manufacturer

### Product personalization

Retailers can use the NFC interface to personalize a product without removing any packaging by writing configuration data to the NFC tag's memory.

#### Benefits

- ▶ Generates new revenue streams
- ▶ Differentiates from competitive offerings

### Multiple product variants from a single platform

An embedded and connected NFC tag's memory provides the ability to support zero-power product configuration. Manufacturers create a single platform, and enable or disable features by storing appropriate configuration data in NFC tag memory.

#### Benefits

- ▶ Fewer PCB versions lowers manufacturing cost
- ▶ Increases flexibility, because configuration can occur at any point in the manufacturing and distribution channel
- ▶ Reduces retail inventory by enabling last minute, in-the-box product configuration changes

### Return logistics

An NFC connected and embedded tag provides a readily accessible memory (even when the power is off) that can hold information such as the product's owner, warranty registration information, service records, etc.

#### Benefits

- ▶ More efficient product servicing
- ▶ Faster return logistics
- ▶ More effective product maintenance
- ▶ Saves time and reduces servicing costs
- ▶ Enables wireless product validation
- ▶ Provides electronic serialization and error code retrieval



# Consumable goods replenishment

When a consumer product has replenishment needs, a consumer might not know exactly which type to purchase or where to find authentic replacements. But when that product contains an NFC tag, a brief pass of their NFC-enabled device over the product can initiate a purchasing cycle for authentic products, and offer a variety of sites from which to purchase the goods. An NFC-enabled product can also optimize product operation upon detection of an authentic part.

## Application examples

- ▶ Refrigerator water filters
- ▶ Furnace filters
- ▶ Automatic coffee machine filters
- ▶ Printer ink cartridges
- ▶ Espresso machine cleaning products
- ▶ Pet products (vitamins, pest control, etc.)

- ▶ Vacuum cleaner bags and filters
- ▶ Carpet cleaner machine solution

## Benefits

- ▶ The consumer can easily retrieve the correct replenishment part information
- ▶ Retrieval of this information initiates a set of purchasing options for the consumer, and sales opportunities for authentic replacement part manufacturers, by directing the consumer to authentic, pre-approved sponsor URL links
- ▶ These vendors can also offer incentive coupons to consumers via the same interaction
- ▶ Manufacturers increase their revenue stream from consumable parts
- ▶ An NFC reader within the product can help notify consumers of expired consumables and optimize product operation when authentic parts are used

## HOW IT WORKS



# NXP's NFC connected tag portfolio

NXP offers a comprehensive portfolio of NXP tag ICs covering a broad range of use cases, such as pairing, personalization, user interface, maintenance, authentication, payment, and more.

**Table 2 NFC connected NTAG tag family features**

Feature	NTAG 213F/216F	NTAG I <sup>2</sup> C
Memory (bytes)	144/888	1K/2K
Power harvesting		✓
Bi-directional I <sup>2</sup> C interface		✓
Field detect	✓	✓
Unique ID	✓	✓
Originality signature	✓	
NFC Counter	✓	
Standard	ISO/IEC 14443A, Type 2	
RF baud rate	106 k bits/s	
Unique ID	7 bytes	
I <sup>2</sup> C speed	N/A	100/400 kHz
Packaging	HXSON4, 1.5x2x0.5 mm	XQFN8, 1.6x1.6x0.5 mm

## NTAG 21xF: NFC plus field detect tag chips

The NTAG 21xF series, which includes a field detect output trigger that can act as an electronic product wake-up interrupt, builds upon the NTAG 21x series. Typical NFC applications include data exchange, wireless connection, pairing, and proximity device communication convenience.

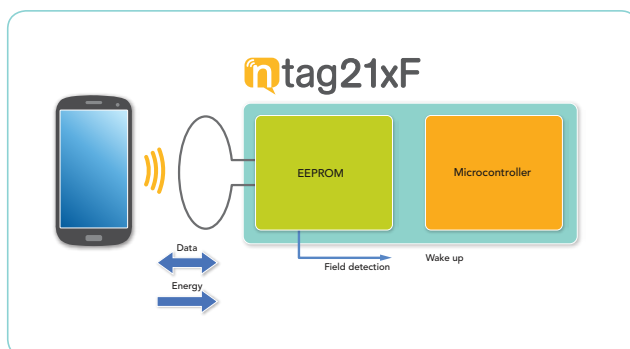

Figure 10. NTAG 21xF tag chip series includes field detect output

NXP's NTAG 21xF series supports these uses and more. The NTAG 21xF series, available in a packaged form compatible with printed circuit board assembly, provides support for gaming, goods and device authentication, Bluetooth/WiFi static pairing, connection handovers, and other embedded electronics applications.

## NTAG I<sup>2</sup>C: NFC, field detect, power harvest, and I<sup>2</sup>C serial bus

NTAG I<sup>2</sup>C tag chips have an additional I<sup>2</sup>C serial bus connection, which further enhances and expands applicable uses. NXP Semiconductors, when still part of Philips, invented the now ubiquitous I<sup>2</sup>C serial bus—a simple, yet elegant means of communicating between electronic devices with minimal physical traces.

The NFC contactless interface, combined with the I<sup>2</sup>C serial bus connected interface, enables wireless bidirectional communication between electronics and NFC-enabled devices, even when the electronic device is not powered. In order to make full use of the I<sup>2</sup>C serial bus interface, the electronic printed circuit board (PCB) usually incorporates the NFC tag. The I<sup>2</sup>C serial bus interface supports communication with the host PCB microcontroller if the NTAG I<sup>2</sup>C has an external power supply or when using the power harvesting feature.

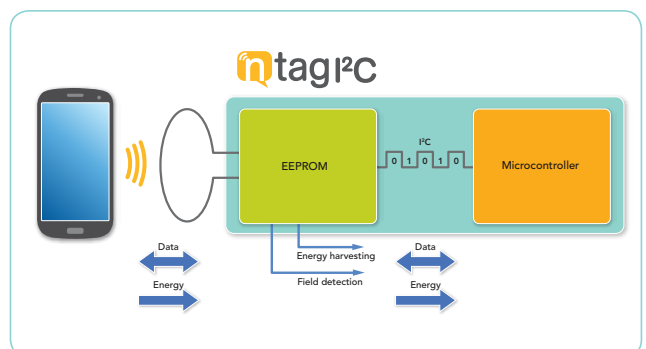

Figure 11. NTAG I<sup>2</sup>C tag chip with field detect and I<sup>2</sup>C serial bus interface

### Data transfer mode using EEPROM (passive/static mode)

When manufacturers embed the NTAG I<sup>2</sup>C tag chip into products, users can download information (e.g., manuals, error codes, even links for consumable replenishment) via the RF interface to those products even when they are not receiving power, because the NTAG I<sup>2</sup>C tag chip acts as a connection between the user's NFC-enabled mobile device and the sealed and packaged product. With power to the device off, the contactless NFC interface can still operate, receiving data that the NTAG I<sup>2</sup>C tag chip stores in nonvolatile EEPROM memory. Later, when the device has power, the microprocessor can access the previously written data via the I<sup>2</sup>C serial bus interface. Similarly, the microprocessor can write data to the EEPROM while powered for later access via the NFC interface whether or not the device has power.

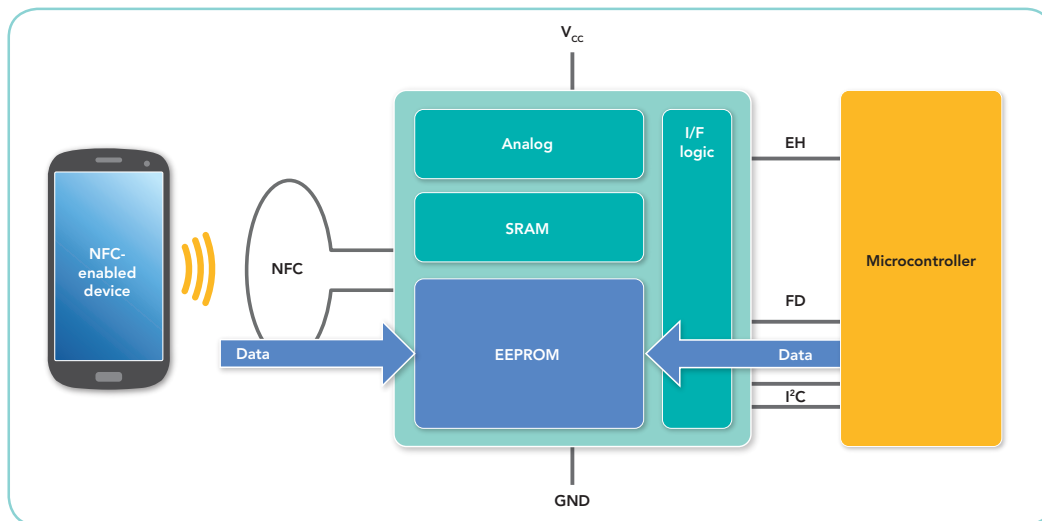

Figure 12. NTAG I<sup>2</sup>C tag chip dual interfaces support data transfer with or without power

### Pass-through mode using SRAM (device-powered mode)

For data transfer after communication has been initiated, the on-chip, 64-byte SRAM preserves EEPROM access limits by supporting a data pass-through option. In this case, data flows from the NFC interface through an SRAM buffer to the I<sup>2</sup>C serial bus interface or vice versa. The NTAG I<sup>2</sup>C tag chip operates like a modem when in this mode.

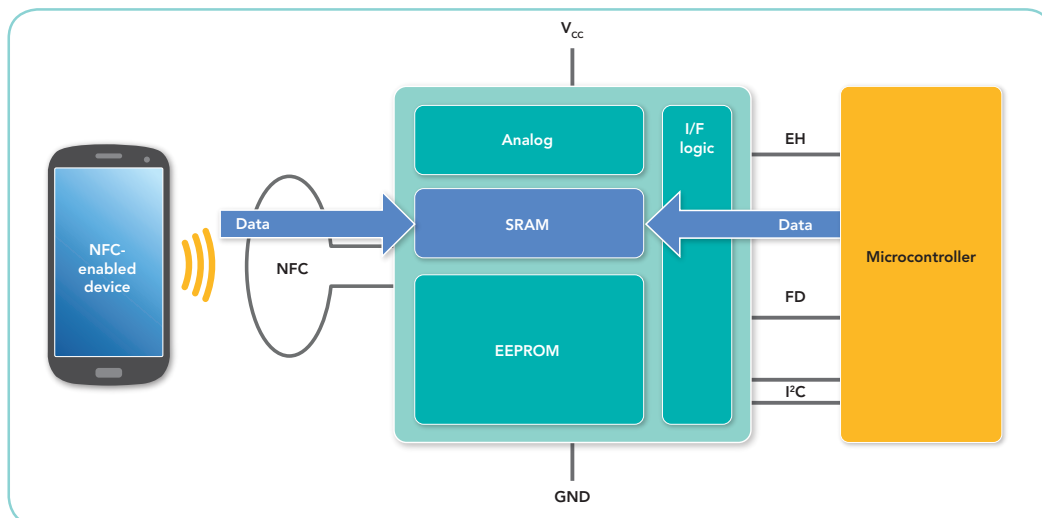

Figure 13. NTAG I<sup>2</sup>C tag chip SRAM enables data pass-through mode and acts as a modem



### Energy harvesting

The NTAG I<sup>2</sup>C tag chip's energy harvesting capability and Field Detect (FD) functions work together to help support power management. Upon application of the RF field to the antenna, the FD output asserts low, and the energy harvested by the NTAG I<sup>2</sup>C tag chip from the RF field is output ( $V_{OUT}$ ) to a Power Management Unit (PMU) (Figure 14 [1]). The PMU distributes received power to both the NTAG I<sup>2</sup>C tag chip and the microcontroller (Figure 14 [2]), which allows the I<sup>2</sup>C bus to become active (Figure 14 [3]), enabling communication. Alternatively, the power harvested by the NTAG I<sup>2</sup>C tag chip can also be applied directly as a source of power for devices requiring less energy, such as low power microcontrollers, sensors and indicators.

### Benefits

- ▶ Enables waterproofing of devices by alleviating the need for connectors
- ▶ Permits power transfer in cases where physical connection is difficult (for example, through glass)
- ▶ Eliminates the need for easily misplaced wires or cables

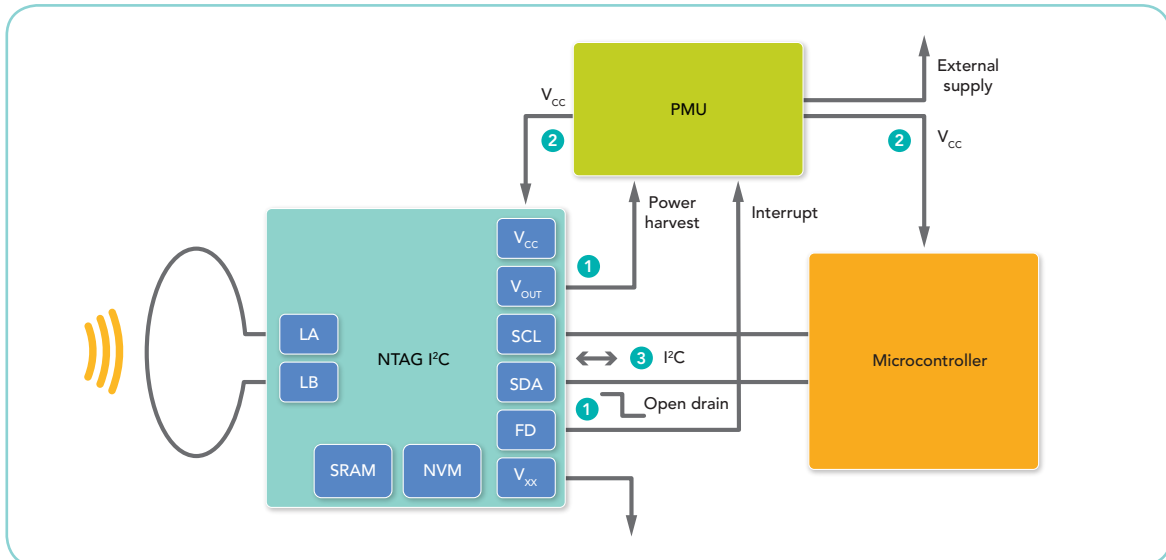

Figure 14. NTAG I<sup>2</sup>C tag chip field detect and power harvesting block diagram

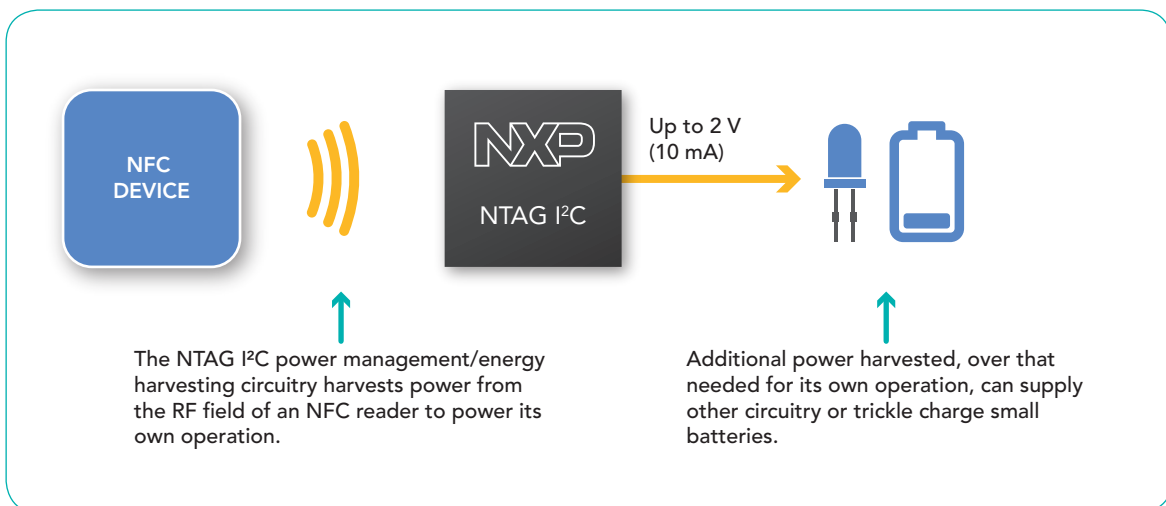

Figure 15. Unused energy from the NFC active device can power additional circuitry





# NXP's NFC Explorer Kit

To demonstrate the unique properties of the NTAG I<sup>2</sup>C tag chip, NXP developed the NFC Explorer Kit, an all-in-one demonstration/development resource for NFC connected tag chips. By including a full complement of hardware and software tools, users can not only investigate the capabilities of the chip through the various demonstrations, but also develop and test their own applications.

NXP's NFC Explorer Kit supports interactive demonstrations and enables exploration of all NTAG I<sup>2</sup>C tag chip capabilities for both the hardware and the application developer.

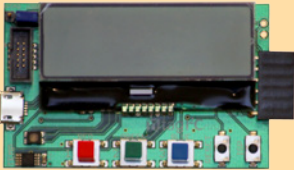
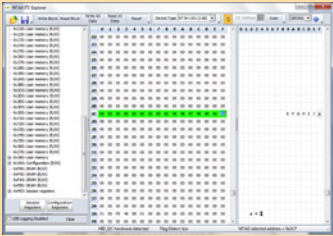
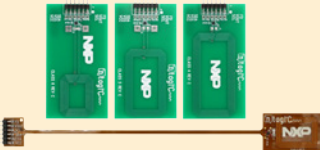
Optionally, the addition of the LPC-Link2 Debugger probe kit allows easy debugging of code ported directly into the NTAG I<sup>2</sup>C Explorer board, facilitating custom applications.

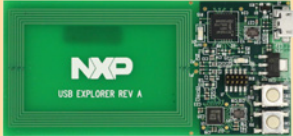
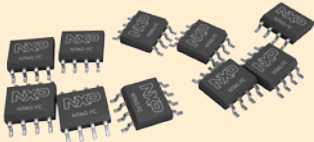
**Table 3 NFC Explorer Kit components**

<p><b>NFC Explorer Board</b> A dual purpose demonstration and development hardware board based on the NXP LPC 11U24 microcontroller, with onboard LCD display, NXP PCT2075 temperature sensor, voltage monitors, I<sup>2</sup>C serial bus connector, and JTAG debug connector to demonstrate bi-directional I<sup>2</sup>C serial bus/NFC communication, illustrate NDEF messaging, monitor energy harvesting capability, and provide a localized application development environment</p>		<p><b>Peek and Poke</b> A PC-based NTAG I<sup>2</sup>C device register and memory exploration software tool with a graphical user interface</p>	
<p><b>NFC Connected Tag Set</b> NTAG I<sup>2</sup>C tag chips mounted on a variety of different antenna types (Class 4, 5, and 6 FR4 PCB-based with separate antenna pads for custom antenna use, as well as a Class 6 Flex-board based for easier product insertion testing) and with built-in I<sup>2</sup>C serial bus interface connectors</p>		<p><b>NFC RF Detector Board</b> An RF detector with visual (LED) output to facilitate location of the optimum RF field, or to ensure that NFC has been enabled</p>	
<p><b>NTAG I<sup>2</sup>C Demo</b> Android™ NTAG I<sup>2</sup>C NFC read/write demonstration application software for NFC-enabled mobile phones</p>		<p><b>USB NFC Reader</b> PC-based PN544PC NFC reader using the NXP LPC11U24 microcontroller with associated graphical user interface and USB-micro to USB cable for those without an NFC-enabled mobile device, where one desires additional performance over the mobile device reader/writer capability, or for embedded applications</p>	
<p><b>NTAG I<sup>2</sup>C packaged samples</b></p>		<p><b>USB/micro USB cable</b></p>	

For more information about this product, please visit:  
[www.nxp-rfid.com/ntag-i2c](http://www.nxp-rfid.com/ntag-i2c)

### Optional LPC-Link2 debug probe

The LPC-Link2 debug probe is a low-cost development tool platform for the LPC MCUs (such as the LPC 11U24) including a target board with integrated debug probe plus debug ribbon cable, and supported by an Eclipse-based integrated development environment.



### Summary

This brochure only touches on some of the many applications made possible by NFC communications. NFC has been specifically designed and engineered to provide zero power operation while maximizing privacy, and to do both at very low cost.

Privacy is inherent in a protocol where consumer intent initiates communication, and read distance is limited by design. The sans power operation saves not only cost, but delivers a whole new set of application possibilities.

Designers have several choices for wireless connectivity, all with tradeoffs. Even in products where longer distance wireless communication is desirable, NFC can enhance product operation and consumer convenience.

NXP Semiconductors offers a full set of NFC products, including tag ICs, reader ICs, and demonstration/development tools. With increasingly widespread availability of NFC-enabled phones, the NXP NFC portfolio enables opportunities for manufacturers to enhance existing designs or create new product lines, opening up additional revenue streams and accessing potentially untapped consumer markets.

For more information visit [www.nxp-rfid.com](http://www.nxp-rfid.com), or to contact NXP, see [nxp-rfid.com/contact](http://nxp-rfid.com/contact)

### About NXP semiconductors

NXP Semiconductors (NASDAQ: NXPI), a global semiconductor company with operations in more than 25 countries, is a key supplier of LF, HF, NFC and UHF RFID solutions, as well as a provider of High Performance Mixed Signal products.





[www.nxp.com](http://www.nxp.com)

© 2014 NXP Semiconductors N.V.

All rights reserved. Reproduction in whole or in part is prohibited without the prior written consent of the copyright owner. The information presented in this document does not form part of any quotation or contract, is believed to be accurate and reliable and may be changed without notice. No liability will be accepted by the publisher for any consequence of its use. Publication thereof does not convey nor imply any license under patent or other industrial or intellectual property rights.

Date of release: August 2014

Document order number: 9397 750 17587

Published in the USA