

Assembly Instructions for - 37320

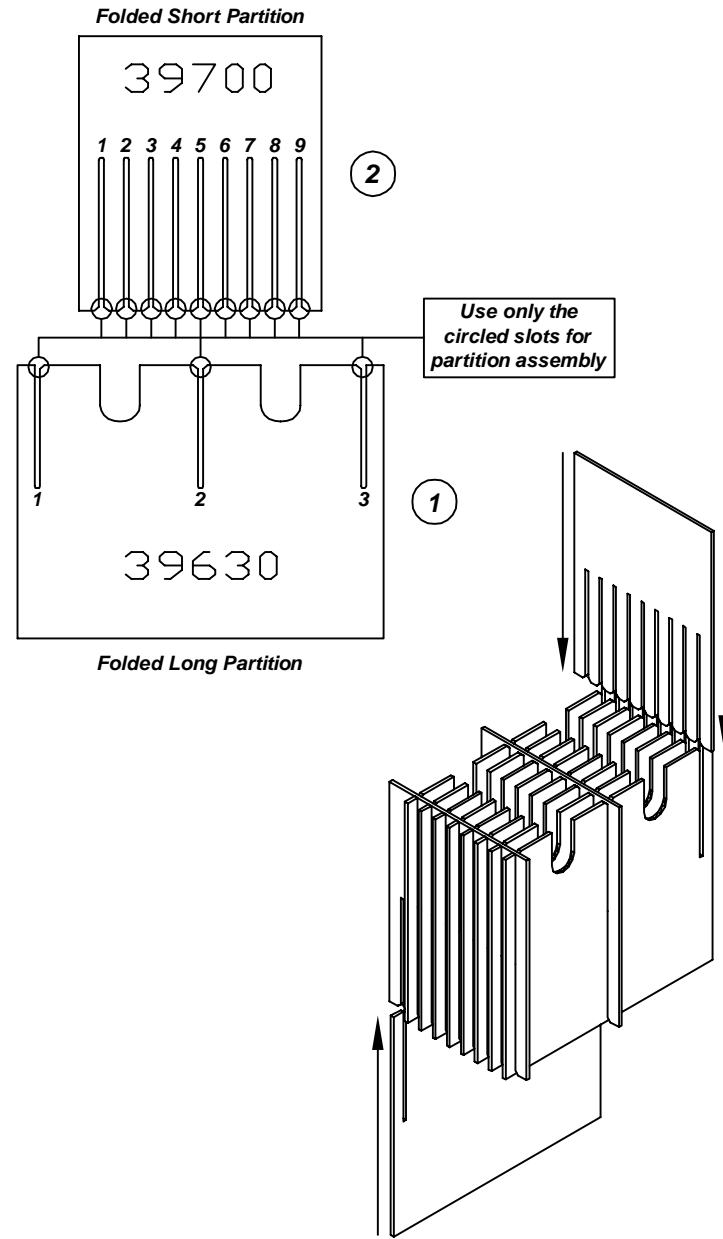
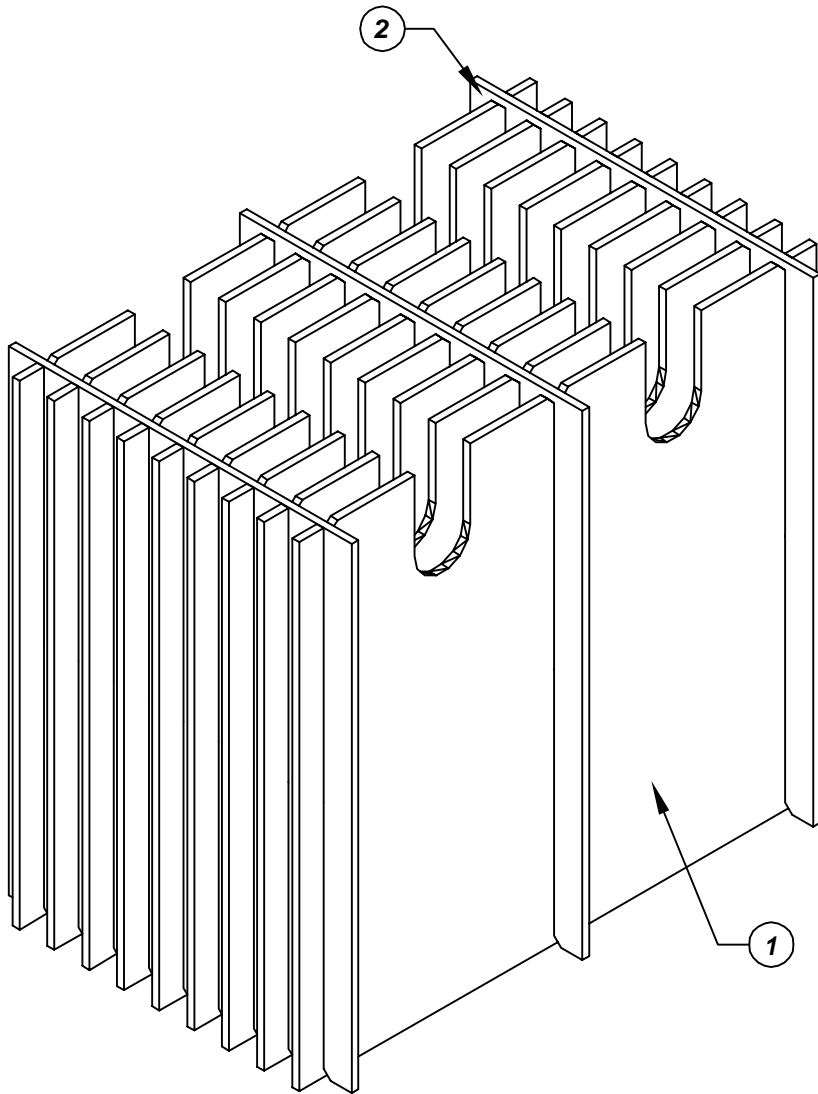

Made in America

F/N ①	Part # 39630	Dimensions: 34-1/8" x 18-3/8"	Description: 405/457-LP Long Partition	Qty: 9
F/N ②	Part # 39700	Dimensions: 34-1/4" x 12-1/4"	Description: 457-SP Short Partition	Qty: 3

Notes:
For use with the following storage container & lid:
37521 - Storage Container
37553 - Lid

PROTEKTIVE PAK
13520 MONTE VISTA AVENUE, CHINO, CA 91710
PHONE (909) 627-2578, FAX (909) 363-7331
ProtektivePak.com



DRAWING NUMBER
IPH-37320

DATE
Dec.
2007

37320 - 20 Cell Inplant Handler
Cell Size - 17-1/8" x 7-3/4" x 1"