



Siretta

Inspired Wireless M2M Technology



SNYPER-3G Spectrum

Cellular Signal and Network Analyser

User Manual

Rev 1.5

Table of Contents

	Page		
Introduction	3	About Menu	37
About Siretta	4	Performing a liveSCAN Survey	38
SNYPER-3G Spectrum Overview	5	liveSCAN Using the Supplied Omni-Directional Antenna (<i>Site Survey</i>)	38
What's in the Box	5	liveSCAN Using a Directional Antenna (<i>Basestation Location</i>)	39
Optional Accessories	5	Downloading Saved Data	40
General Description	5	SNYPER-3G Spectrum Antenna	41
Features	6	Using Other Antennas with the SNYPER-3G Spectrum	41
Specifications	7	Siretta Recommends	42
SNYPER-3G Spectrum Product Images	8	Safety Product and Care	43
SNYPER-3G Spectrum Dimensions	11	General Precautions	43
Powering the SNYPER-3G Spectrum	12	Exposure to RF Energy	43
Power On	12	Safety Recommendations	45
Charging and Battery Status	13	Conformity Assessment	46
Main Menu	14	Disclaimer	47
Power Off	15	Definitions	48
Saved Results Menu	16		
Viewing Saved Survey Results	17		
Viewing Saved Summary Results	19		
Survey Menu	22		
Viewing Current Survey	22		
Performing a Survey	24		
Viewing Survey Results	25		
Summary Menu	26		
Saving a Survey	29		
SNYPER-3G Spectrum Setup Menu	30		
Saving Setup Preferences	31		
Software Options Menu	32		
ADV Option	33		
Restoring to Factory Default	35		
Saving Option Preferences	36		

Introduction

This document is intended to explain how to use the SNYPER-3G Spectrum to survey network signals.

The SNYPER-3G Spectrum is a range of GSM and UMTS cellular signal analysers, designed for surveying wireless systems.

This document discusses the modes of operation and device states, in addition to the electrical characteristics of the device interfaces.

About Siretta

Siretta, located in Reading, United Kingdom have been manufacturing antennas, cable assemblies and cellular terminals for over 10 years. We supply our products globally to many of the world's leading organisations.

Whether you require an off the shelf or custom solution, Siretta has a wide portfolio of antenna, RF cable assemblies and terminals to fit your application.

Our extensive knowledge and experience in the wireless market allows us to support a wide range of customer applications, focusing on frequencies typically within the 75MHz - 5.8GHz range. These encompass the HF, VHF, ISM, GSM/GPRS/3G/4G and GPS frequencies as well as industrial WLAN and VHF/UHF antenna/Wi-Fi antenna solutions.

With a heavy emphasis on design, we have a team of dedicated Application Engineers and Product Managers, backed up by Field Sales Engineers, who specialise in wireless applications.

We have made significant investments in R&D facilities which boast GPS hardware development equipment and a GSM Pico Cell on site, as well as development software and a comprehensive suite of Industrial, Scientific and Medical band, and non ISM band frequency products. We have many technology partners enabling us to keep at the forefront of the communications industry and offer class leading wireless solutions.

SNYPER-3G Spectrum Overview

What's in the Box?

As standard, the SNYPER-3G Spectrum comes with the following:*

- » SNYPER-3G Spectrum signal and network analyser
- » Multi region power supply
- » Antenna
- » USB cable
- » Hard carrying case
- » Quick start guide

Optional Accessories

The SNYPER-3G Spectrum has the following accessories:

- » liveSCAN directional antenna kit

General Description

The SNYPER-3G Spectrum is a high performance cellular signal and network analyser for all 3G and 2G networks, with a host of important features for the busy engineer and installer.

The SNYPER-3G Spectrum can perform a number of different functions to determine optimum antenna placement and direction, performance of existing installations of network operator. As an example, the SNYPER-3G Spectrum can determine the strength of a particular network and the optimum direction of the antenna using the liveSCAN feature.

The SNYPER-3G Spectrum has been designed to be as logical as possible, with a simple to use menu and operation system. Provided with a large high contrast LCD display, the SNYPER-3G Spectrum ensures all the information is clearly visible, and allows the presentation of considerable data at the same time.

The liveSCAN high performance directional antenna kit (sold separately) has been specifically designed to complement the SNYPER-3G Spectrum when performing live scans.

*For replacement parts, please contact your Siretta representative or call us on +44 (0)118 976 9014

Features

The SNYPER-3G Spectrum has the following features:

- » Measures and displays received network signal strength
- » Lock onto a single provider to perform real time liveSCAN
- » liveSCAN data provided as real time graphical display
- » Typically last 50 surveys stored on SNYPER-3G Spectrum
- » USB download of last 50 surveys to a PC
- » Large easy to read LCD display
- » Robust enclosure for rugged and continuous use
- » Long life rechargeable battery gives up to 48hours on one charge
- » Up to 15 hours continuous liveSCAN use
- » Battery can last up to 4 months in standby mode
- » Supplied in a convenient hard carrying case with mains charger, USB cable, antenna and quick start guide
- » liveSCAN high performance directional antenna kits (sold separately)

Specifications

Table 1. Specifications of SNYPER-3G Spectrum

	SNYPER-3G Spectrum
2G supported bands:	850, 900, 1800, 1900MHz
3G supported bands:	900, 2100MHz
Dimensions:	141 x 76 x 36mm
Weight:	215g
Antenna dimensions:	78 x 11mm
Operating temperature range:	-20 to +75°C
Storage temperature range:	-40 to +85°C
Operating humidity range:	0 to 90% RH non-condensing
Antenna connector:	SMA male
Display:	2.4" QVGA 320 x 240 RGB TFT
Battery life:	48 hours normal use*
Battery:	2000mAh
Warm up time:	2s
Mains adapter input:	100 - 240V 50/60Hz
Mains adapter connector:	3 pin UK, 2 pin EU, US, AU
Charger output:	5V DC 2000mA
Charger connector:	USB Mini-B
Stored survey memory:	Up to 50

*Based on 20 surveys in each 24 hours with automatic power off enabled

SNYPER-3G Spectrum Product Images

Figure 1. Front view of the SNYPER-3G Spectrum



*The SNYPER-3G Spectrum SIM slot located in the enclosure base is used for enhanced network services. A SIM is only required when performing a liveSCAN on a specific network operator. The SIM has to be active, but it will not use any data during the liveSCAN survey as it is only required for network functionality.

Figure 2. Bottom view of the SNYPER-3G Spectrum



Figure 3. Top view of the SNYPER-3G Spectrum (Without antenna)

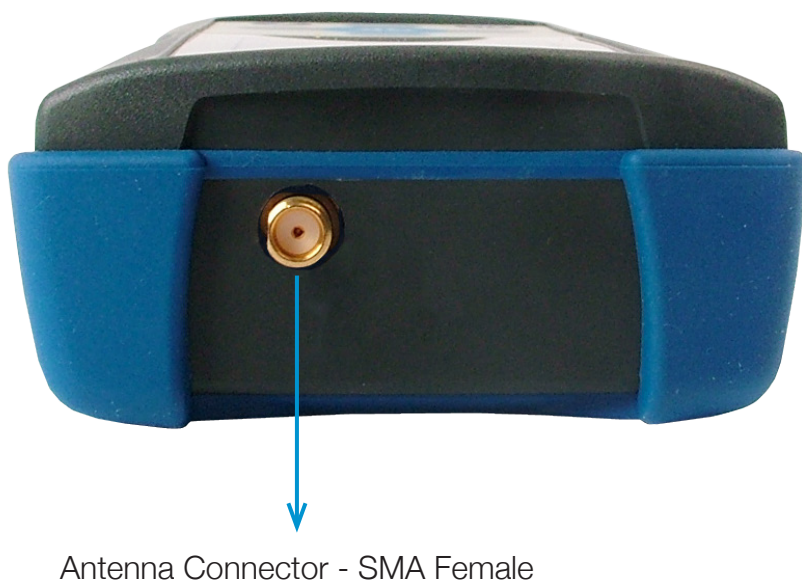

Figure 4. Rear view of the SNYPER-3G Spectrum



SNYPER-3G Spectrum Dimensions

The SNYPER-3G Spectrum dimensions are measured in mm.

Figure 5. SNYPER-3G Spectrum front view dimensions

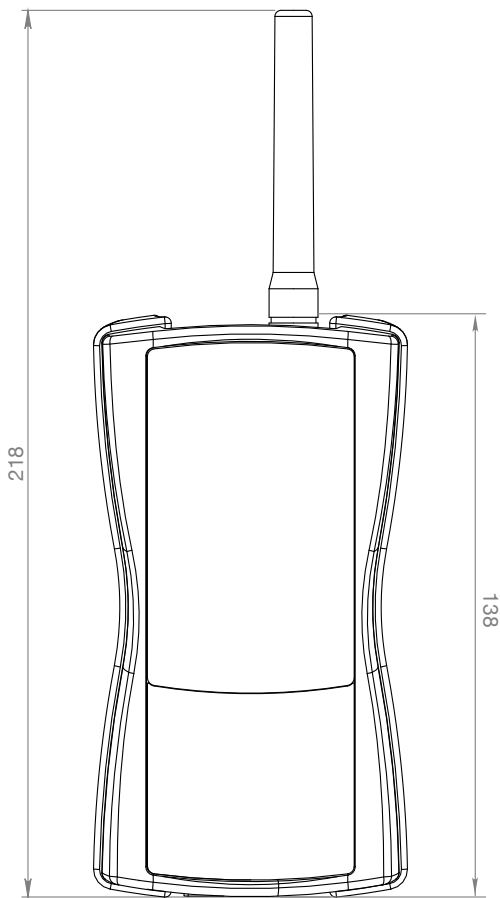

Figure 6. SNYPER-3G Spectrum side view dimensions

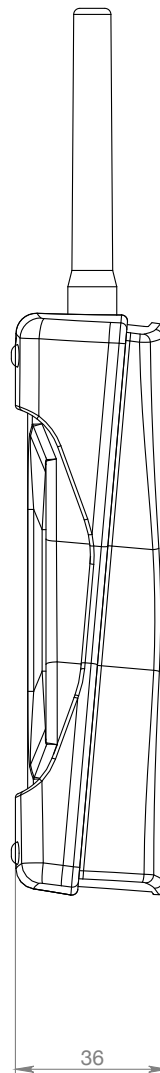
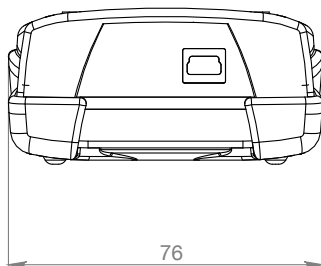

Figure 7. SNYPER-3G Spectrum bottom view dimensions



Powering the SNYPER-3G Spectrum

Power On

- » The SNYPER-3G Spectrum needs to be charged using the mains adaptor for 6 - 8 hours before initial use. The SNYPER-3G Spectrum does **not** need a SIM card to perform network and signal tests.
- » Ensure the antenna is screwed firmly into place on the SNYPER-3G Spectrum and isn't loose.
- » To power up the SNYPER-3G Spectrum press the ON/OFF button. A welcome screen will be displayed briefly (as shown below in figure 9) before the main menu is displayed (as shown over page in figure 10.)

Figure 8. ON/OFF button



Figure 9. Power on message



Charging and Battery Status

Approximately 4 - 6 hours are needed to fully charge the unit using the default fast charging mode. The SNYPER-3G Spectrum battery provides up to 15 hours continuous liveSCAN use and up to 4 months standby mode.

Figure 10. Charging and battery status

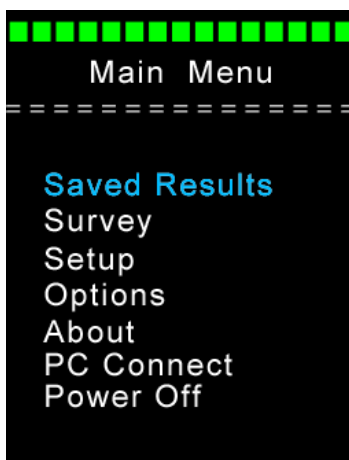

Charging and battery status bar:

During charging, the number of bars will increase and turn from red, to yellow, to green. The charge status LED will be red.

A full line of green bars indicates that the unit is fully charged.

During use, the number of bars will decrease and turn from green, to yellow, to red.

Recharging is recommended once red bars are displayed on the SNYPER-3G Spectrum battery status bar.

If the SNYPER-3G Spectrum drops below allowable low battery usage the unit will switch off and charging will be required. At power on, if the battery is below allowable low battery usage a low battery indicator will be displayed as shown below in figure 11.

NOTE - During low power charge the SNYPER-3G Spectrum will display the battery screen (as shown below in figure 12) until the SNYPER-3G Spectrum has enough power to be used.

Figure 11. Low battery screen



Figure 12. Low power charge screen



Main Menu

The SNYPER-3G Spectrum main menu has 7 menus (as shown below in figure 13), these can be selected using the UP/DOWN buttons. Once the chosen menu is highlighted, click OK. Press the BACK button to return to the main menu.

Figure 13. 'Main Menu' screen

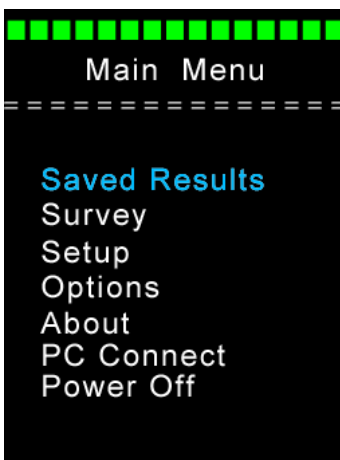

Saved Results

Saved Results: Reviews previously saved survey.

Survey

Survey: Used to perform a new survey.

Setup

Setup: Basic setups of the SNYPER-3G Spectrum.

Options

Options: User options for the SNYPER-3G Spectrum.

About

About: Displays information about the SNYPER-3G Spectrum.

PC Connect

PC Connect: Download of data to PC.

PC Connect

Power Off: Powers off the SNYPER-3G Spectrum.

Power Off

After use, remember to power off the SNYPER-3G Spectrum. The SNYPER-3G Spectrum can be powered off in the following 2 ways:

- » Selecting the 'Power Off' option from the main menu. The SNYPER-3G Spectrum will display a power off message as shown below in figure 15.

Figure 14. Select 'Power Off'

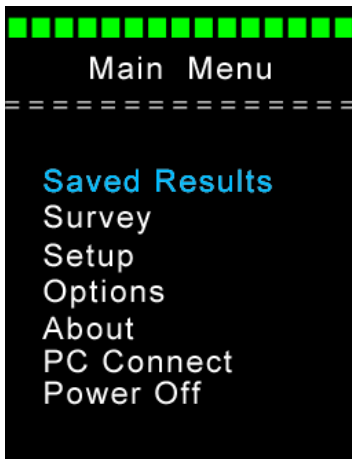

Figure 15. Power off message



- » Press and hold the ON/OFF button on the SNYPER-3G Spectrum for >2 seconds. The SNYPER will display a power off message as shown below in figure 17.

Figure 16. ON/OFF button



Figure 17. Power off message



Saved Results Menu

The 'Saved Results' menu allows you to review saved survey results on the SNYPER-3G Spectrum. The SNYPER-3G Spectrum can store up to 50 survey results.

Using the UP/DOWN buttons, select the saved results that you want to view.

Figure 18. 'Saved Results' screen



Viewing Saved Survey Results

Step 1. From the 'Saved Results' menu, select the saved results that you require to be displayed (GSM & UMTS / GSM Only / UMTS Only).

Figure 19. 'Saved Results' screen

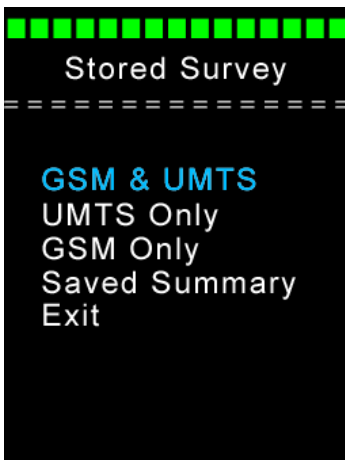

GSM & UMTS

GSM & UMTS: Displays saved GSM & UMTS survey results.

UMTS Only

UMTS Only: Displays saved UMTS survey results.

GSM Only

GSM Only: Displays saved GSM survey results.

Saved Summary

Summary: Displays a summary of signal strengths from the saved survey.

Exit

Exit: Returns to the SNYPER-3G Spectrum main menu.

Step 2. From the 'Saved Results' menu, select the saved results that you require to be displayed (GSM & UMTS / GSM Only / UMTS Only).

NOTE - To switch between all saved signals, use the LEFT/RIGHT buttons (LEFT displays stronger signal, RIGHT displays weaker signal).*

Figure 20. Strongest saved signal

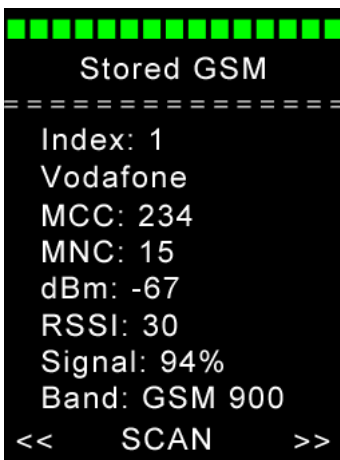
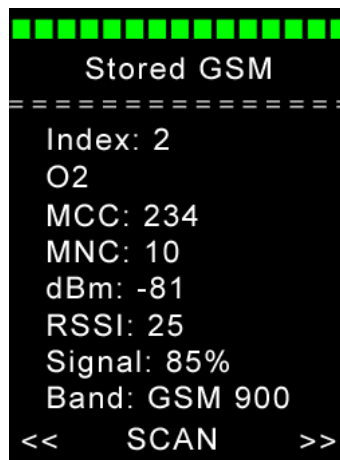

Figure 21. Next strongest saved signal



Press the back button to return to the 'Saved Results' menu.

*See section 'ADV Option' on page 33 for information about the displayed results.

Viewing Saved Summary Results

By selecting 'Summary' from the 'Current Survey' menu, a summary of all network signals detected in the survey will be displayed. Results are displayed in order of strength within signal strength bands across different screens.

To display higher or lower signal strengths received on the SNYPER-3G Spectrum, click the LEFT/ RIGHT buttons (LEFT displays higher signal strengths, RIGHT displays lower signal strength). The signal strengths are displayed in 15% steps, decreasing in signal strength from 85% to 10%.

NOTE - To display a summary of GSM or UMTS results, click the UP/DOWN buttons to scroll between GSM and UMTS network list.

The example in **table 2** below shows the following:

- » A Vodafone cell had the strongest signal sensed in the area
- » O2, T-Mobile and Orange cells were sensed at a weaker strength

Table 2. Summary of network signals

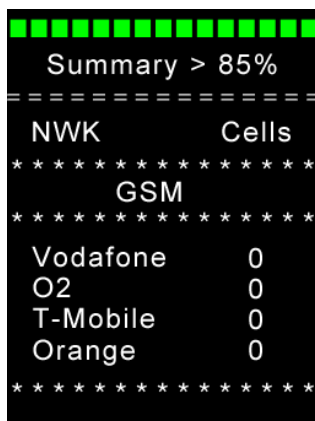

Summary > 85%	
NWK	Cells
GSM	
Vodafone	0
O2	0
T-Mobile	0
Orange	0

85% Signal Strength

The SNYPER-3G Spectrum is displaying all 2G networks that were received at 85%.

At this level, none of the networks had cells with this signal strength.

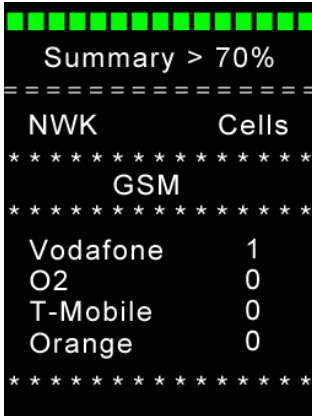

Summary > 70%	
NWK	Cells
GSM	
Vodafone	1
O2	0
T-Mobile	0
Orange	0

70% Signal Strength

The SNYPER-3G Spectrum is displaying all 2G networks that were received at 70%.

At this level, Vodafone had 1 cell being received.

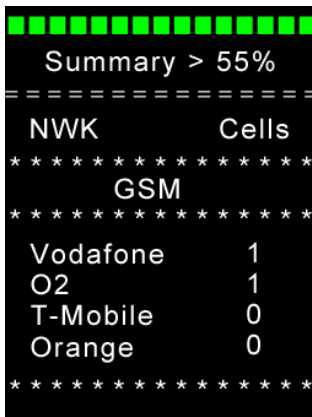

Summary > 55%	
NWK	Cells
GSM	
Vodafone	1
O2	1
T-Mobile	0
Orange	0

55% Signal Strength

The SNYPER-3G Spectrum is displaying all 2G networks that were received at 55%.

At this level, O2 had 1 cell being received.

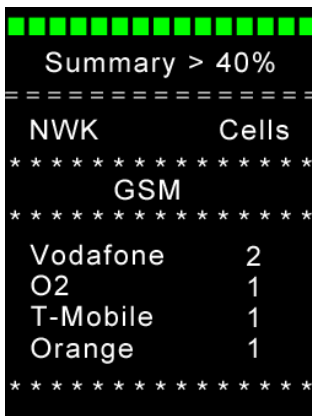

Summary > 40%	
NWK	Cells
GSM	
Vodafone	2
O2	1
T-Mobile	1
Orange	1

40% Signal Strength

The SNYPER-3G Spectrum is displaying all 2G networks that were received at 40%.

At this level, 1 additional Vodafone cell was being received at a weaker strength than the previous cell received.

There was also 1 T-Mobile cell and 1 Orange cell that were being received at this signal strength.

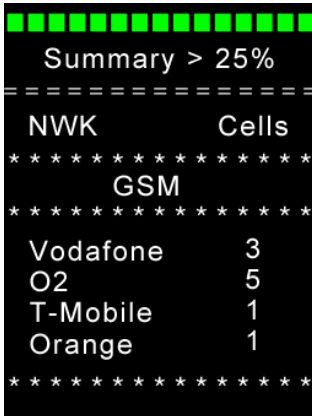

Summary > 25%

NWK	Cells

GSM	

Vodafone	3
O2	5
T-Mobile	1
Orange	1

25% Signal Strength

The SNYPER-3G Spectrum is displaying all 2G networks that were received at 25%.

At this level, 1 additional Vodafone cell and 4 additional O2 cells were being received at a weaker strength than the previous cells received.

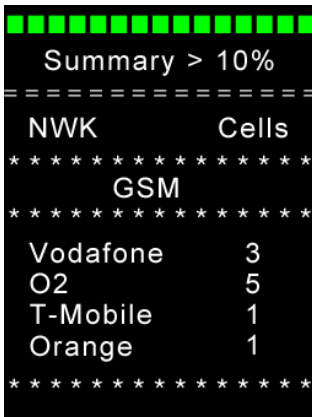

Summary > 10%

NWK	Cells

GSM	

Vodafone	3
O2	5
T-Mobile	1
Orange	1

10% Signal Strength

The SNYPER-3G Spectrum is displaying all 2G networks that were received at 10%.

At this level, there were no further cells being received by the SNYPER-3G Spectrum.

Press the back button to return to the 'Saved Results' menu.

Survey Menu

The 'Survey' menu allows you to review a current survey or perform a new survey.

Figure 22. 'Survey' screen

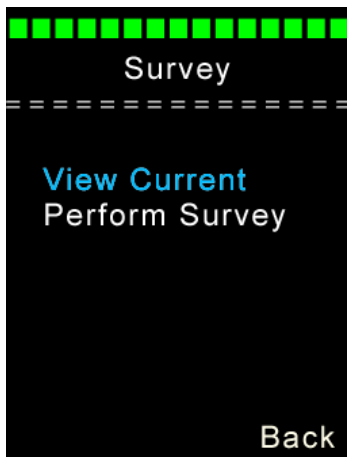

View Current

View Current: Displays most recently performed survey.

Perform Survey

Perform Survey: Performs a survey on the SNYPER-3G Spectrum.

Viewing Current Survey

Step 1. To view the most recently performed survey* on the SNYPER-3G Spectrum, select 'View Current' from the 'Survey Menu'. The 'Current Survey' screen will be displayed, as shown below in figure 23. If there are no current survey results available, the SNYPER-3G Spectrum will display a message as shown below in figure 24.

Figure 23. 'Stored Survey' screen

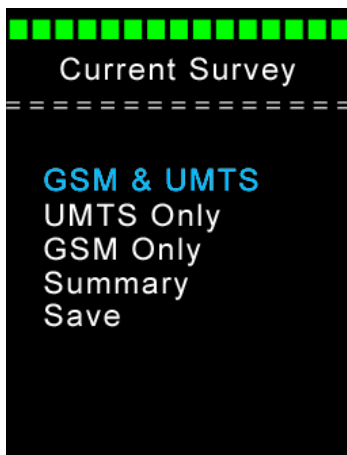

Figure 24. No current survey results available



*The most recently performed survey is available until the SNYPER-3G Spectrum is powered off.

Step 2. From the 'Current Survey' menu, select the results that you require to be displayed (GSM & UMTS / GSM Only / UMTS Only).

NOTE - To switch between all signals found in the survey, use the LEFT/RIGHT buttons (LEFT displays stronger signal, RIGHT displays weaker signal).*

Figure 25. Strongest signal found in the survey

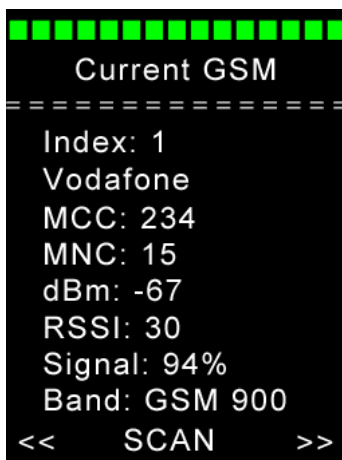
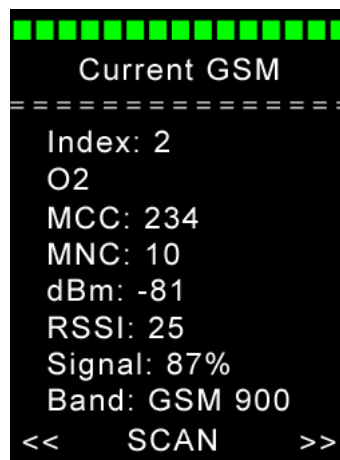

Figure 26. Next strongest signal found in the survey



Press the back button to return to the 'Current Survey' menu.

*See section 'ADV Option' on page 33 for information about the displayed results.

Performing a Survey

Step 1. Select 'Perform Survey' from the 'Survey' menu, this will automatically begin a new survey. Whilst the survey is being performed, the SNYPER-3G Spectrum will display a sequence of messages as shown below in figures 27 - 29.

Figure 27. Initialising survey



Figure 28. Performing survey

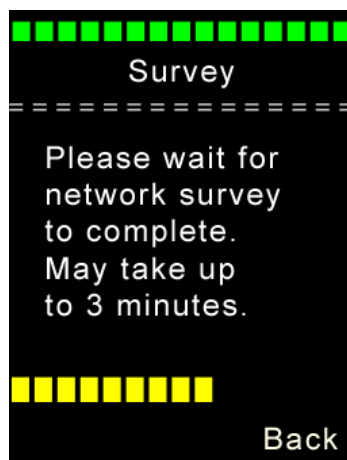
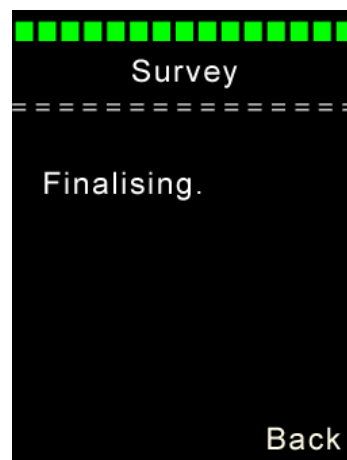
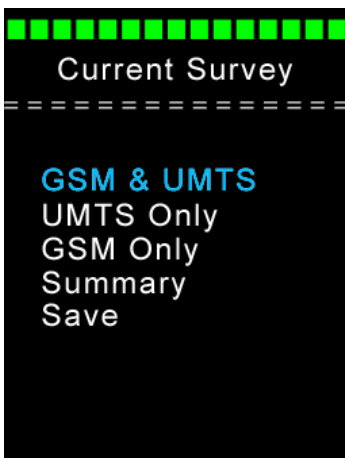

Figure 29. Finalising survey



Step 2. Once the survey is complete, the screen will display a 'Current Survey' menu as shown below in figure 30. The 'Current Survey' menu has 5 menus, these are selected using the UP/DOWN buttons. Once the chosen sub menu is highlighted, click OK.

Figure 30. 'Current Survey' screen



GSM & UMTS

GSM & UMTS: Displays GSM & UMTS survey results.

UMTS Only

UMTS Only: Displays UMTS survey results.

GSM Only

GSM Only: Displays GSM survey results.

Summary

Summary: Displays a summary of signal strengths from the survey.

Save

Save: Saves the results of the performed survey.

Viewing Survey Results

Step 1. From the 'Current Survey' menu, select the results that you require to be displayed (GSM & UMTS / GSM Only / UMTS Only).

NOTE - To switch between all signals found in the survey, use the LEFT/RIGHT buttons (LEFT displays stronger signal, RIGHT displays weaker signal).*

Figure 31. Strongest signal found in the survey

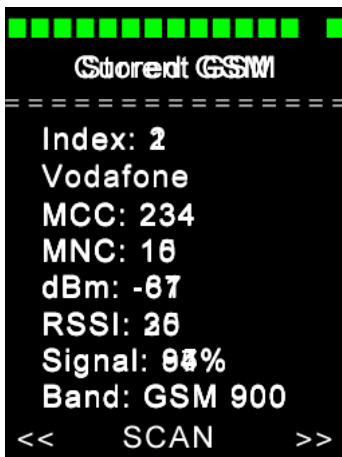
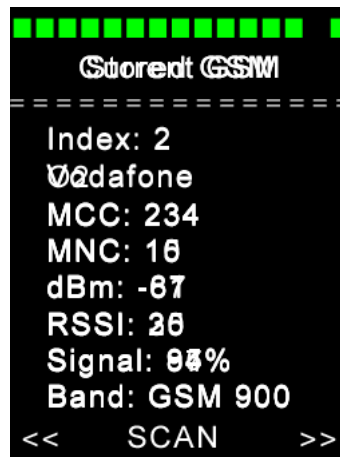

Figure 32. Next strongest signal found in the survey



Press the back button to return to the 'Current Survey' menu.

*See section 'ADV Option' on page 33 for information about the displayed results.

Summary Menu

By selecting 'Summary' from the 'Current Survey' menu, a summary of all network signals detected in the survey will be displayed. Results are displayed in order of strength within signal strength bands across different screens.

To display higher or lower signal strengths received on the SNYPER-3G Spectrum, click the LEFT/ RIGHT buttons (LEFT displays higher signal strengths, RIGHT displays lower signal strength). The signal strengths are displayed in 15% steps, decreasing in signal strength from 85% to 10%.

NOTE - To display a summary of GSM or UMTS results, click the UP/DOWN buttons to scroll between GSM and UMTS network list.

The example in **table 3** below shows the following:

- » A Vodafone cell had the strongest signal sensed in the area
- » O2, T-Mobile and Orange cells were sensed at a weaker strength

Table 3. Summary of network signals

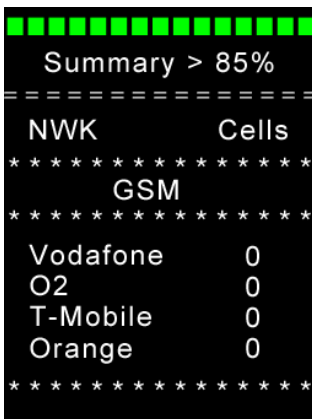

The screenshot shows a terminal-style display with a black background and white text. At the top, there is a row of 12 green squares. Below that, the text reads 'Summary > 85%' followed by a dashed line separator. The main content is a table with two columns: 'NWK' and 'Cells'. Under the 'NWK' column, the word 'GSM' is centered. Below 'GSM', the network names 'Vodafone', 'O2', 'T-Mobile', and 'Orange' are listed. The 'Cells' column shows the value '0' for each network. The table is framed by asterisks on the top and bottom rows.

NWK	Cells
GSM	
Vodafone	0
O2	0
T-Mobile	0
Orange	0

85% Signal Strength

The SNYPER-3G Spectrum is displaying all 2G networks being received at 85%.

At this level, none of the networks have cells with this signal strength.

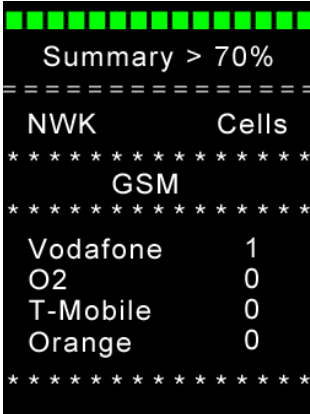

NWK	Cells
GSM	
Vodafone	1
O2	0
T-Mobile	0
Orange	0

70% Signal Strength

The SNYPER-3G Spectrum is displaying all 2G networks being received at 70%.

At this level, Vodafone shows 1 cell being received.

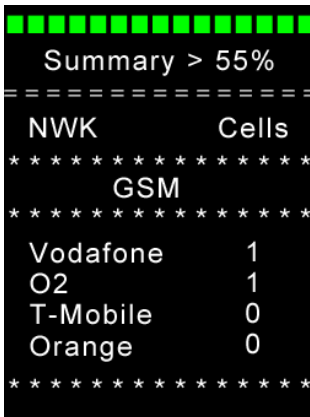

NWK	Cells
GSM	
Vodafone	1
O2	1
T-Mobile	0
Orange	0

55% Signal Strength

The SNYPER-3G Spectrum is displaying all 2G networks being received at 55%.

At this level, O2 now shows 1 cell being received.

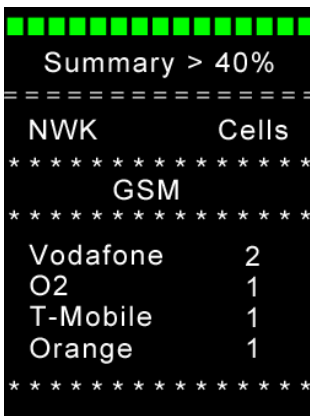

NWK	Cells
GSM	
Vodafone	2
O2	1
T-Mobile	1
Orange	1

40% Signal Strength

The SNYPER-3G Spectrum is displaying all 2G networks being received at 40%.

At this level, there is 1 additional Vodafone cell being received at a weaker strength than the previous cell received.

There is also 1 T-Mobile cell and 1 Orange cell being received at this signal strength.

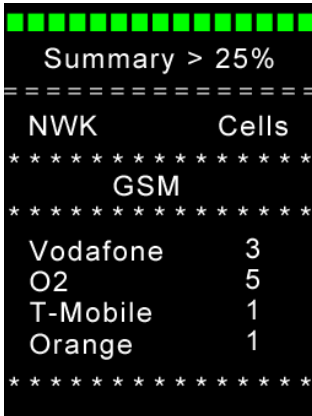

Summary > 25%

NWK	Cells
GSM	
Vodafone	3
O2	5
T-Mobile	1
Orange	1

25% Signal Strength

The SNYPER-3G Spectrum is displaying all 2G networks being received at 25%.

At this level, there is 1 additional Vodafone cell and 4 additional O2 cells being received at a weaker strength than the previous cells received.

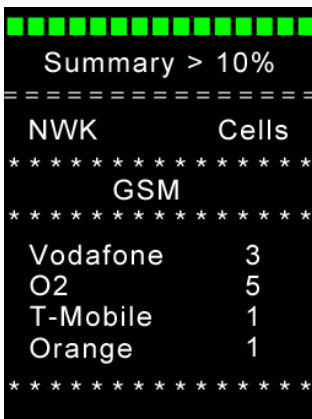

Summary > 10%

NWK	Cells
GSM	
Vodafone	3
O2	5
T-Mobile	1
Orange	1

10% Signal Strength

The SNYPER-3G Spectrum is displaying all 2G networks being received at 10%.

At this level, there are no further cells being received by the SNYPER-3G Spectrum.

Press the back button to return to the 'Current Survey' menu.

Saving a Survey

Step 1. Once you have performed a survey, you can save the results by selecting 'Save' from the 'Current Survey' menu.*

Step 2. Once the 'Save' option is highlighted, you will be prompted to select 'YES' to confirm the save, or 'NO' to cancel the save. Whilst results are being saved, a message will be displayed as shown below in **figure 33**.

Figure 33. Saving survey results to the SNYPER-3G Spectrum



Once the survey has been stored, the SNYPER-3G Spectrum will return to the main menu. To review the saved survey, see section 'Saved Results Menu' on **page 16**.

NOTE - The SNYPER-3G Spectrum can store up to 50 surveys.

*The SNYPER doesn't automatically save survey results, if you wish to save results from a survey follow steps 1 and 2 above. If you do not wish to save results from a survey, return to the main menu. Results which aren't saved will be immediately lost.

SNYPER-3G Spectrum Setup Menu

By selecting 'Setup' from the main menu, the following setup changes can be made (as shown below in figure 34). To select a sub menu use the UP/DOWN button until relevant menu is highlighted, then use the LEFT/RIGHT buttons to amend preference.

Figure 34. 'Setup' screen

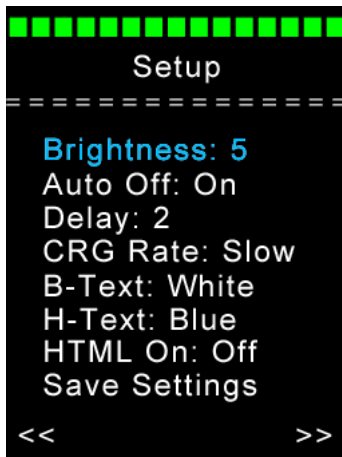

Brightness: 5

Brightness: SNYPER-3G Spectrum LCD brightness. The screen brightness has 6 settings, 0 (lowest) - 5 (highest).

Auto Off: On

Auto Off: Automatic power off of the SNYPER-3G Spectrum. The auto off has 2 settings, on or off.

Delay: 2

Delay: Time in minutes the SNYPER-3G Spectrum stays on after last button press. The delay has 5 settings, 1 minute - 5 minutes.

CRG Rate: Slow

CRG Rate: Battery charging rate of the SNYPER-3G Spectrum. The charging rate has 2 settings, slow or fast.

B-Text: White

B-Text: Colour of body text on the LCD screen. The SNYPER-3G Spectrum has 13 body text colour settings.

H-Text: Blue

H-Text: Colour of highlighted text on the LCD screen. The SNYPER-3G Spectrum has 13 highlighted text colour settings.

HTML On: Off

HTML On: Generate HTML report. The HTML on has 2 setting, on or off.

HTML On: Off

Save Settings: Saves setup menu changes. Saves any changes made to the setup menu.

Saving Setup Preferences

Step 1. Once you have amended your setup preferences, you can save the new settings by selecting 'Save Settings' from the 'Setup' menu.*

Step 2. Once the 'Save Settings' option is highlighted, you will be prompted to select 'YES' to confirm the save, or 'NO' to cancel the save. Whilst the settings are being saved, a message will be displayed as shown below in **figure 35**.

Figure 35. Saving settings to the SNYPER-3G Spectrum



Once the settings have been stored, the SNYPER-3G Spectrum will return to the main menu.

*The SNYPER-3G Spectrum doesn't automatically save setup preferences, if you wish to save new setup follow steps 1 and 2 above. If you do not wish to save new setups, return to the main menu.

Software Options Menu

By selecting 'Options' from the main menu, the following options can be selected (as shown below in figure 36). To select a sub menu use the UP/DOWN button until relevant menu is highlighted, then use the LEFT/RIGHT buttons to amend preference.

Figure 36. 'Options' screen

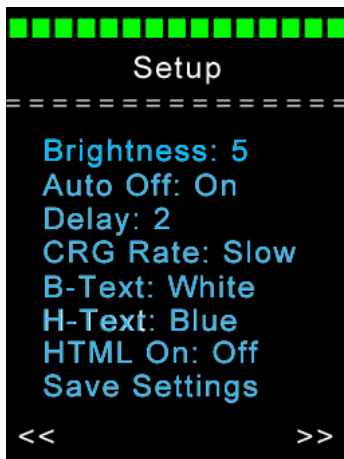

Brightness: 5

ADV: The SNYPER-3G Spectrum mode of operation. The adv has 3 settings, standard, advanced or engineer mode.*

Auto Off: On

Factory Default: Defaults **all** options to factory state.

Delay: 2

Save Settings: Saves option menu changes. Saves any changes made to the options menu.

*See section 'ADV Option' over page for more information about SNYPER-3G Spectrum modes of operation.

ADV Option

The ADV option determines the operation mode of the SNYPER-3G Spectrum when performing a survey. There are 3 options: Standard, Advanced or Engineer - each will display a different range of results once a survey has been performed. The results displayed will vary depending on whether the SNYPER is a 2G or 3G version, see **table 4 - 6** below for more information.

Standard Mode - Standard mode receives and displays a basic range of results and is the factory default operation mode of the SNYPER-3G Spectrum. When performing a survey in Standard mode the following results will be displayed:

Table 4. Standard mode

Operating Band	SNYPER-3G Spectrum
	UMTS
Index - Base station number assigned by the SNYPER-3G Spectrum	✓
Network - Name of the network provider	✓
MCC - Mobile Country Code being received	✓
MNC - Mobile Network Code being received	✓
dBm - Signal strength being received (Signal strength ranges from -51 to -115dBm, the lower the number the higher the signal strength.)	✓
RSSI - Received Signal Strength Indicator (Values range from 0 - 31, the higher the number the higher the signal strength.)	✓
Signal - Percentage signal received (Values range from 0% - 100%, the higher the number the higher the signal strength.)	✓
Band - Frequency band being received	✓
BER - Bit error rate in %	

Advanced Mode - Advanced mode receives and displays a more advanced range of results in addition to the results displayed in Standard mode. When performing a survey in Advanced mode the following results will be displayed:

Table 5. Advanced mode

Operating Band	SNYPER-3G Spectrum
	UMTS
CellID - Unique ID of the network cell being received	✓
ARFCN - Absolute Radio Frequency Channel Number being received	
UARFCN – UTRA Absolute Radio Frequency Channel Number being received	✓
BSIC - Base Station Identity Code being received	
SCR – Basestation scrambling code	✓
LAC - Location Area Code being received	✓

Advanced mode also enables the feature 'liveSCAN'. liveSCAN performs a real time network scan. For more information on how to perform a liveSCAN, see [page 38](#).

Restoring to Factory Default

Step 1. To perform a factory reset on the SNYPER-3G Spectrum, select 'Factory Default' from the 'Options' menu.

Step 2. Once the 'Factory Default' option is highlighted, you will be prompted to select 'SET' to confirm the reset, to do this press the 'OK' button.

Figure 37. Saving factory default settings to the SNYPER-3G Spectrum



Selecting the factory default option will default **ALL** of the SNYPER-3G Spectrum values to their factory setting. Once the SNYPER has been restored, it will return to the 'Main Menu'.

Saving Option Preferences

Step 1. Once you have amended the SNYPER-3G Spectrum options, you can save the new settings by selecting 'Save Settings' from the 'Options' menu.*

Step 2. Once the 'Save Settings' option is highlighted, you will be prompted to select 'YES' to confirm the save, or 'NO' to cancel the save. Whilst the settings are being saved, a message will be displayed as shown below in **figure 38**.

Figure 38. Saving settings to the SNYPER-3G Spectrum



Once the settings have been stored, the SNYPER-3G Spectrum will return to the main menu.

*The SNYPER-3G Spectrum doesn't automatically save changed options, if you wish to save new setup follow steps 1 and 2 above. If you do not wish to save new setups, return to the main menu.

About Menu

By selecting 'About' from the main menu, information about the SNYPER will be displayed (as shown below in figure 39).

Figure 39. 'About' screen

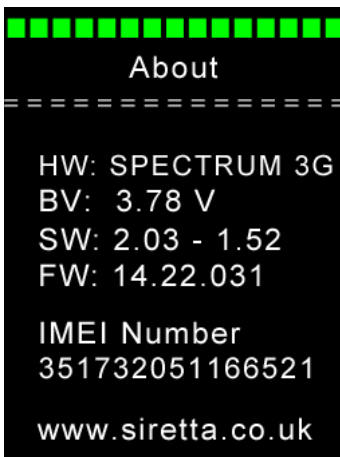

HW: SPECTRUM 3G

HW: SNYPER-3G Spectrum hardware version

The hardware version determines whether the SNYPER-3G Spectrum works on GSM or UMTS networks.

BV: 3.78 V

BV: SNYPER-3G Spectrum battery voltage

The battery voltage (measured in Volts) the SNYPER-3G Spectrum is running on.

SW: 2.03 - 1.52

SW: SNYPER-3G Spectrum software version

The current application and loader software versions running on the SNYPER-3G Spectrum.

FW: 14.22.031

FW: SNYPER-3G Spectrum firmware version

The current modem firmware software version running on the SNYPER-3G Spectrum.

IMEI Number 351732051166521

IMEI Number: SNYPER-3G Spectrum (IMEI) number

The unique IMEI number of the SNYPER-3G Spectrum.

Performing a liveSCAN Survey

The SNYPER-3G Spectrum liveSCAN feature allows you to perform a real-time scan of your chosen network. liveSCANS can be performed at your survey site immediately after a network survey has been completed.

The liveSCAN feature is intended to identify areas of strong cellular network signal strength during a site survey and to locate the position of surrounding base-stations for the chosen network.

Note: This operation requires an active SIM card to be inserted in the SNYPER-3G Spectrum.

Any SIM card can be used as the liveSCAN will be performed for all networks, regardless of the SIM card inserted.

liveSCAN Using the Supplied Omni-Directional Antenna (Site Survey)

This allows you to identify / locate areas of highest signal strength (“hotspots”) for your chosen network as you survey your site location during a site survey.

To perform a Site Survey liveSCAN, follow the steps below:

Step 1. From the ‘Options’ menu, set the SNYPER-3G Spectrum to ‘ADV: Advanced’ and ‘Save Settings’. This option enables the liveSCAN feature.

Step 2. Perform a new survey.

Step 3: Using the UP/DOWN buttons, select GSM or UMTS results and click ‘OK’.

Step 4: Select the desired network to scan using the LEFT/RIGHT buttons and press ‘OK’ to perform liveSCAN.

liveSCAN Using a Directional Antenna (Basestation Location)

This allows you to aim your directional antenna in the position which will obtain the maximum received signal strength for a given location on the specified network.

To perform a liveSCAN you will need to obtain the optional liveSCAN Antenna Kit (see Siretta Recommends on page 42).

To perform a Basestation Location liveSCAN, follow the steps below:

Step 1. From the 'Options' menu, set the SNYPER-3G Spectrum to 'ADV: Advanced' and 'Save Settings'. This option enables liveSCAN feature.

Step 2. Perform a new survey.

Step 3: Once survey has completed (as shown below in figure 40), remove the omni-directional antenna and replace with the optional liveSCAN antenna and cable. Ensure the cable is screwed firmly into place on both the SNYPER-3G Spectrum and liveSCAN antenna.

Step 4. Using the UP/DOWN buttons, select GSM or UMTS results and click 'OK'.

Step 5. Select desired network to scan using the LEFT/RIGHT buttons and press 'OK' to perform liveSCAN.

Figure 40. Survey completed

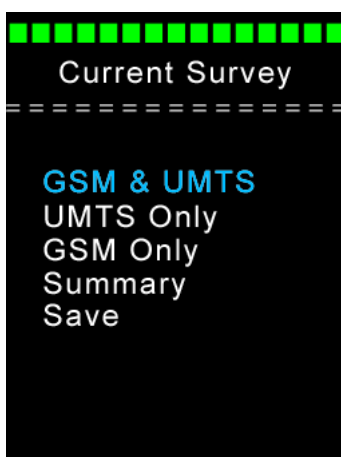
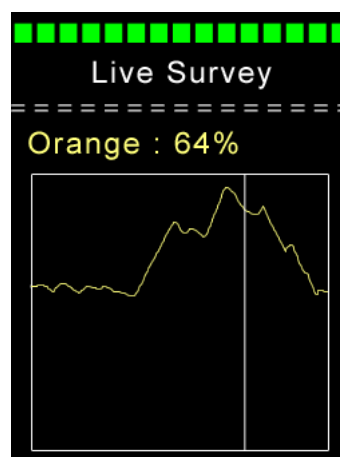

Figure 41. Performing a liveSCAN



To cancel the liveSCAN function, press and hold the BACK button to return to the previous menu.

Downloading Saved Data

The SNYPER-3G Spectrum data download feature allows you to download the last 50 saved surveys onto your PC.

The data is downloaded to your PC in excel spreadsheet format. The downloaded data will include GSM and UMTS survey and summary results.

To download data from your SNYPER-3G Spectrum, follow the steps below:

Step 1. Connect supplied USB cable to the SNYPER-3G Spectrum and PC.

Step 2. From the SNYPER-3G Spectrum 'Main Menu' select 'PC Connect' and 'Enable'. From the PC select 'Open Folder to View Files' and open saved files as required.

Figure 42. SNYPER-3G Spectrum data download

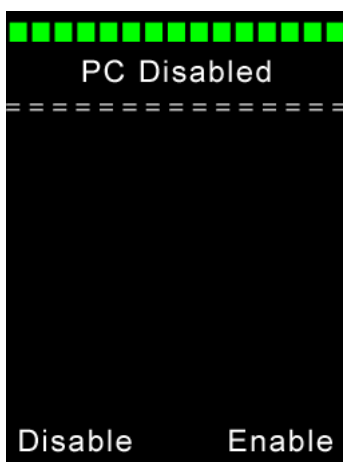
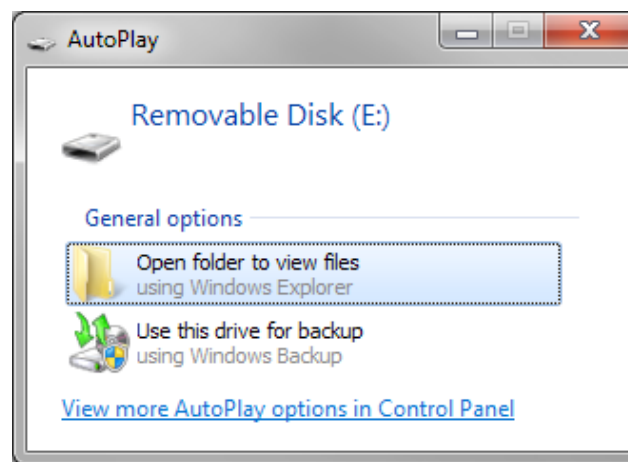

Figure 43. Downloading SNYPER-3G Spectrum data to PC



To disable the PC connection, select 'Disable' on the SNYPER-3G Spectrum and remove the USB cable.

Your SNYPER-3G Spectrum will now be back to normal operation.

SNYPER-3G Spectrum Antenna

Using Other Antennas with the SNYPER-3G Spectrum

The SNYPER-3G Spectrum can be easily used to evaluate other antennas. The evaluation of other antennas is carried out to find the strongest signal available for a particular application. The antenna with the strongest results will be used.

Evaluating other antennas:

1. Unscrew supplied antenna from the SNYPER-3G Spectrum.
2. Connect the antenna to be evaluated.
(The new antenna must have an SMA male connector to connect to the SNYPER-3G Spectrum. If the chosen antenna has a different connector, then an RF adaptor will need to be used (these are available from Siretta*).
3. With the antenna connected to the SNYPER-3G Spectrum, a survey can be performed. If evaluating multiple antennas, operator details and signal levels can be noted and compared to find the best antenna.

The SNYPER-3G Spectrum can also be easily used to evaluate directional antennas (such as Yagi). The evaluation of directional antennas is carried out to find which position of the antenna receives the strongest signal. The position with the strongest results will be used.

Evaluating directional antennas (such as Yagi):

1. Follow steps 1 and 2 as above
2. Adjust antenna's directional position towards the desired operators mast. Note the signal levels received.
3. Repeat step 3, this process should be continued until the antenna direction with the strongest signal is found.

*Please contact your Siretta representative or visit www.siretta.co.uk

Siretta Recommends

SNYPER-3G Spectrum signal analysers will require extra product to perform some of the features, these are all available from Siretta. Below are some of the products we recommend for your SNYPER-3G Spectrum:

Product	Part No.	Description
Kits		
Directional liveSCAN Antenna Kit 	60173	<p>The SNYPER-3G Spectrum liveSCAN feature allows you to perform a real-time scan of your chosen network. liveSCANS can be performed at your survey site immediately after a network survey has been completed.</p> <p>The directional liveSCAN antenna kit comes in a carry case, containing liveSCAN antenna and a 1.5m SMA Male to SMA Male cable.</p>

Safety and Product Care

General Precautions

- » Do not exceed the environmental and electrical limits as specified.
- » Avoid exposing the SNYPER-3G Spectrum to lit cigarettes, naked flames or to extreme hot or cold temperatures.
- » Never try to dismantle the SNYPER-3G Spectrum. There are no components on the SNYPER-3G Spectrum that can be serviced by the user. If you attempt to dismantle the SNYPER-3G Spectrum, you will invalidate the warranty.
- » Do not connect any incompatible component or product to the SNYPER-3G Spectrum signal analysers.

Exposure to RF Energy

There has been some public concern about possible health effects of using GSM equipment in close proximity to a person or body. Although research on health effects from RF energy has focused for many years on the current RF technology, research has begun on new radio technologies, such as GSM and UMTS. After existing research had been reviewed, and after compliance to all applicable safety standards has been tested, it has been concluded that the SNYPER-3G Spectrum analyser is fit for use.

If you are concerned about exposure to RF energy, there are a number of things you can do to minimize exposure. Obviously, limiting the duration of time near a device will reduce your exposure to RF energy. In addition, you can reduce RF exposure by operating your SNYPER-3G Spectrum efficiently by adhering to the following guidelines:

Electronic devices: Most electronic equipment, for example in hospitals and motor vehicles is shielded from RF energy. However, RF energy may affect some malfunctioning or improperly shielded electronic equipment.

Vehicle electronic equipment: Check your vehicle manufacturer's representative to determine if any on board electronic equipment is adequately shielded from external RF energy.

Medical electronic equipment: Consult the manufacturer of any personal medical devices (such as pacemakers, hearing aids, etc.) to determine if they are adequately shielded from external RF energy.

Turn your device OFF in health care facilities when any regulations posted in the area instruct you to do so. Hospitals or health care facilities may be using RF monitoring equipment.

Aircraft: Turn your device OFF before boarding any aircraft. To prevent possible interference with aircraft systems, Federal Aviation Administration (FAA) regulations require you to have permission from a crew member to use your terminal equipment whilst the plane is on the ground. To prevent interference with cellular systems, local RF regulations prohibit using your modem whilst in the air.

Blasting areas: To avoid interfering with blasting operations, turn your device OFF when in a “blasting area” or in areas posted: “turn off two-way radio“. Construction crew often uses remote control RF devices to set off explosives.

Potentially explosive atmospheres: Turn your device OFF when in any area with a potentially explosive atmosphere. It is rare, but your SNYPER or their accessories could generate sparks. Sparks in such areas could cause an explosion or fire resulting in bodily injury or even death.

Areas with a potentially explosive atmosphere are often, but not always, clearly marked. They include fuelling areas such as petrol stations, below deck on boats, fuel or chemical transfer or storage facilities and areas where the air contains chemicals or particles, such as grain, dust or metal powders. Do not transport or store flammable gas, liquid or explosives, in the compartment of your vehicle, which contains your SNYPER or accessories. Before using your terminal in a vehicle powered by liquefied petroleum gas (such as propane or butane) ensure that the vehicle complies with the relevant fire and safety regulations of the country in which the vehicle is to be used.

Safety Recommendations

PLEASE READ CAREFULLY

Be sure the use of this product is allowed in the country intended and the environment required. The use of this product may be dangerous and has to be used with caution in the following areas:

- » Where it can interfere with other electronic devices in environments such as hospitals, airports, aircrafts, etc
- » Where there is risk of explosion such as gasoline stations, oil refineries, gas works etc

It is responsibility of the user to enforce the country regulation and the specific environment regulation.

Do not disassemble the product, any mark of tampering will compromise the warranty.

Should there be any doubt, please refer to the technical documentation and the regulations in force.

Conformity Assessment

The SNYPER-3G Spectrum range of signal analysers has been designed to conform to the R&TTE Directive for use as a stand-alone product. If the analyser is used in compliance with the user guide instructions then no further evaluation is required under Article 3.2 of the R&TTE Directive and no further involvement of an R&TTE Directive Notified Body is required for the final application.

The SNYPER-3G Spectrum range of signal analysers conform to the following European Union Directives:

- » R&TTE Directive 1999/5/EC (Radio Equipment & Telecommunications Terminal Equipment)
- » LVD (Low Voltage Directive) 73/23/EEC and product safety
- » Directive 89/336/EEC for conformity for EMC

In order to satisfy the essential requisite of the R&TTE 99/5/EC directive, the SNYPER-3G Spectrum range of signal analysers are compliant with the following standards:

- » GSM (Radio Spectrum). Standard: EN 301 511 and 3GPP 51.010-1
- » EMC (Electromagnetic Compatibility). Standards: EN 301 489-1 and EN 301 489-7
- » Include stand-alone spurious emissions to Clause 8.2 of EN 301 489-1.
- » LVD (Low Voltage Directive) Standards: EN 60 950

Disclaimer

The information contained in this document is proprietary to Siretta Ltd. Siretta has made every effort to ensure that the accuracy of the information contained within this document is accurate. Siretta does not make any warranty as to the information contained within this document and does not accept any liability for any injury, loss or damage of any kind incurred by the use of this information.

Siretta does not take responsibility for any application developed using the device characterized in this document and notes that any application of this device must comply with the safety standards of the applicable country and comply with the relevant wiring rules. Siretta reserves the right to make modifications, additions and deletions to this document due to typographical errors, inaccurate information, or improvements to equipment at any time and without notice. Such changes will be incorporated into new editions of this document.

All rights reserved.

© 2015 Siretta Ltd

Definitions

Term	Definition
2G	2nd Generation Mobile Telecommunications
3G	3rd Generation Mobile Telecommunications
ARFCN	Absolute Radio Frequency Channel Number
BSIC	Base Station Identity Code
CellID	Cell Identity
dBm	Decibels per meter
DL	Downlink
GPRS	General Packet Radio Service
GSM	Global System for Mobile Communications
IMEI	International Mobile Equipment Identity
LAC	Location Area Code
LCD	Liquid Crystal Display
LED	Light Emitting Diode
MCC	Mobile Country Code
MNC	Mobile Network Code
RSSI	Received Signal Strength Indicator
SCR	Basestation Scrambling Code
SIM	Subscriber Identity Module
SMA	Sub Miniature version A
UARFCN	UTRA Absolute Radio Frequency Channel Number
UL	Uplink
UMTS	Universal Mobile Telecommunications System (Same as 3G)
USB	Universal Serial Bus

Become A Distributor

Siretta is currently growing its worldwide distributor and reseller base.

Distributors can benefit from marketing and technical support, along with the widest range of Antennas, Connectors, Cable Assemblies, Modems, Signal Testers and Routers.



sales +44 (0)118 976 9014
fax +44 (0)118 976 9020
accounts +44 (0)118 976 9069
email sales@siretta.co.uk

www.siretta.co.uk

Siretta Ltd
Basingstoke Road
Spencers Wood
Reading
Berkshire
RG7 1PW
United Kingdom

Company No. 08405712
VAT Registration No. GB163 04 0349

A member of the Olanca Group Ltd



Rev 1.5