

DATA SHEET

| | |
|------------------|-----------------|
| Part No. | MN63Y1210A |
| Package Code No. | SSOP016-P-0225E |

About this manual

■ Organization

These specifications provide important information for users of the MN63Y1210A-E1, including an overview and descriptions of functions.

■ Manual Configuration

Each section of this manual consists of a title, main text, and notes. The layout and definition of each section are shown below.

1.1 UART

This section describes the UART specification.

1.1.1 Communication Specifications

Table 1-1 shows the UART specification of this RFID.

Table 1-1 UART Communication Specification

| | |
|------------------------|---|
| Data transfer method | Asynchronous, half-duplex (Only IRQ notification allows full-duplex) |
| Data rate | 200 bps, 2400 bps, 4800 bps, 9600 bps, 19200 bps, 38400 bps |
| Character transmission | <ul style="list-style-type: none"> ·LSB-first ·Data (8 bits) ·Start bit (1bit) ·Parity bit (1bit, even) ·Stop bit (1bit) See Note below. |
| Other | No flow control signal (RTS/CTS) |

Note: In order to ensure the timing margin, when sending consecutive data from the host, use a 2-bit stop bit or set the interval between stop bit and next start bit to 1 bit or more.

Middle title

Small title

Text

Note

This is the Note.
Please read.

■ Finding Desired Information

This manual provides two methods for finding desired information quickly and easily.

1. Consult the table of contents at the front of the manual to locate desired titles.
2. Chapter names are located at the top outer corner of each page, and section titles are located at the bottom outer corner of each page.

Chapter 1 Overview

1

Chapter 2 Pin Descriptions

2

Chapter 3 Memory Map

3

Chapter 4 RF Communication Mode

4

Chapter 5 Serial Communication Mode

5

Chapter 6 Tunnel Mode

6

Chapter 7 Annex

7

Chapter 8 Electrical characteristics

8

Contents

| | |
|---|-----------|
| Chapter 1 Overview | 9 |
| 1.1 Features..... | 10 |
| 1.2 Block Diagram..... | 11 |
| 1.3 Operation Mode..... | 12 |
| Chapter 2 Pin Descriptions | 15 |
| 2.1 List of Pins..... | 16 |
| 2.2 Pin Descriptions..... | 17 |
| 2.3 Connection Example..... | 19 |
| 2.3.1 Using UART and 5 V Power..... | 19 |
| 2.3.2 Using UART and 3 V Power..... | 20 |
| 2.3.3 Using Clock Synchronous Mode and 5 V Power..... | 21 |
| 2.3.4 Using Clock Synchronous Mode and 3 V Power..... | 22 |
| Chapter 3 Memory Map | 23 |
| 3.1 Block Configuration | 24 |
| 3.2 Physical Memory Map..... | 25 |
| 3.3 System Area..... | 26 |
| 3.3.1 Parameter Specifications | 26 |
| 3.3.2 Enabling System Area | 31 |
| 3.4 Address Correspondence | 32 |
| Chapter 4 RF Communication Mode | 33 |
| 4.1 RF Communication Mode Sequence..... | 34 |
| 4.2 JISX6319-4 Specification..... | 35 |
| 4.2.1 Communication Specifications..... | 35 |
| 4.2.2 Frame Format | 35 |
| 4.2.3 State Transition Diagram..... | 36 |
| 4.2.4 Flow Chart..... | 36 |
| 4.2.5 Various Settings | 37 |
| 4.2.5.1 System Code | 37 |
| 4.2.5.2 PICC (Proximity IC Card) Identifier | 37 |
| 4.2.5.3 Response Time Descriptor..... | 37 |
| 4.2.5.4 Anticollision..... | 38 |
| 4.2.5.5 Service..... | 38 |
| 4.2.5.6 Block..... | 39 |
| 4.2.5.7 Block List..... | 40 |
| 4.2.5.8 Status Flag..... | 42 |
| 4.2.6 Command | 43 |
| 4.2.6.1 REQ..... | 44 |

| | |
|---|----|
| 4.2.6.2 READ..... | 45 |
| 4.2.6.3 WRITE..... | 47 |
| 4.2.7 NDEF..... | 49 |
| 4.2.7.1 MEMORY MAP..... | 49 |
| 4.2.7.2 Setup of System Code (SC)..... | 50 |
| 4.2.7.3 Setup of Attribute Information Block..... | 50 |
| 4.2.7.4 NDEF FILE..... | 51 |
| 4.3 ISO/IEC14443 TypeB Specification..... | 52 |
| 4.3.1 Communication Specification..... | 52 |
| 4.3.2 Frame Format..... | 52 |
| 4.3.3 Protocol Control..... | 53 |
| 4.3.4 Block Control..... | 54 |
| 4.3.5 Upper Command Format..... | 55 |
| 4.3.6 State Transition Diagram..... | 57 |
| 4.3.7 Flow Chart..... | 58 |
| 4.3.8 Various Settings..... | 59 |
| 4.3.8.1 AFI (Application Family Identifier)..... | 59 |
| 4.3.8.2 PUPI (Pseudo-Unique PICC Identifier)..... | 59 |
| 4.3.8.3 FWI (Frame Waiting Time Integer)..... | 59 |
| 4.3.8.4 File System..... | 60 |
| 4.3.8.5 Address..... | 60 |
| 4.3.8.6 Data..... | 61 |
| 4.3.8.7 Status Word..... | 61 |
| 4.3.9 Command..... | 63 |
| 4.3.9.1 REQB/WUPB..... | 64 |
| 4.3.9.2 ATTRIB..... | 66 |
| 4.3.9.3 HLTB..... | 68 |
| 4.3.9.4 SELECT..... | 69 |
| 4.3.9.5 READ..... | 70 |
| 4.3.9.6 WRITE..... | 71 |

Chapter 5 Serial Communication Mode..... 73

| | |
|---|----|
| 5.1 Serial Communication Mode Sequence..... | 74 |
| 5.2 UART..... | 75 |
| 5.2.1 Communication Specifications..... | 75 |
| 5.2.2 Frame Format..... | 75 |
| 5.2.3 Specifying Data Rate..... | 76 |
| 5.2.4 Specifying Response Wait Time..... | 76 |
| 5.2.5 Status..... | 76 |
| 5.2.6 Command..... | 77 |
| 5.2.6.1 READ..... | 78 |
| 5.2.6.2 WRITE..... | 79 |
| 5.3 Clock Synchronous Serial Communication..... | 80 |
| 5.3.1 Communication Specification..... | 80 |
| 5.3.2 Frame Format..... | 80 |
| 5.3.3 Time Chart..... | 81 |
| 5.3.4 Status..... | 81 |

| | |
|--|------------|
| 5.3.5 Command | 81 |
| Chapter 6 Tunnel Mode | 83 |
| <hr/> | |
| 6.1 Tunnel Mode Sequence | 84 |
| 6.2 Communication between Reader/Writer and RFID | 85 |
| 6.2.1 Using JISX6319-4 | 85 |
| 6.2.2 Using ISO/IEC14443 | 85 |
| 6.3 Communication between Host and RFID | 86 |
| 6.3.1 Using UART | 86 |
| 6.3.1.1 Communication Specification | 86 |
| 6.3.1.2 IRQ Notification | 86 |
| 6.3.2 Using Clock Synchronous Serial | 88 |
| 6.3.2.1 Communication Specification | 88 |
| 6.3.2.2 IRQ Notification | 88 |
| 6.3.2.3 Configuring System Area (UARTSP Setting) | 88 |
| 6.3.3 Response to QUERY Command | 89 |
| 6.3.4 Timeout | 89 |
| 6.3.4.1 Wait Time for QUERY Command | 90 |
| 6.3.4.2 Wait Time for ANSWER Command | 90 |
| 6.4 Command | 92 |
| 6.4.1 Read in Tunnel Mode | 93 |
| 6.4.2 Write in Tunnel Mode | 96 |
| Chapter 7 Annex | 99 |
| <hr/> | |
| 7.1 Exclusive Control | 100 |
| 7.2 State Transition Diagram in Operation Mode | 103 |
| 7.3 Flow Chart in Tunnel Mode | 104 |
| 7.4 Maximum Command Processing Time (UART) | 106 |
| Chapter 8 Electrical characteristics | 107 |
| <hr/> | |

1.1 Features

The MN63Y1210A is an LSI for RFID (Radio Frequency Identification), which features the following:

- Built-in 4-Kbit FeRAM non-volatile memory with fast write and low power consumption.
- RF interface compliant with JISX6319-4 (212 kbps / 424 kbps) and ISO/IEC14443 TypeB (106 kbps / 212 kbps) of the 13.56-MHz contactless IC card standards.
- Serial interface compatible with both asynchronous UART (up to 38.4 kbps) and clock synchronous (up to 1 Mbps)
- Batteryless RF communication
- Three communication modes of RF, serial, and tunnel (Tunnel mode allows communications between reader/writer and host CPU via this LSI.)
- Supply voltage range: 1.8 V to 3.6 V or 4.5 V to 5.5 V (when 5V tolerant I/O and clamp function is turned ON)
- 5-V operation (5V tolerant I/O, VDD2 pin clamp circuit built-in)

1.2 Block Diagram

Figure 1-1 shows a block diagram.

This RFID provides RF interface for contactless communication with external reader/writer, serial interface for contact communication with external host, control logic for command processing and various controls, 2-kbit transmit/receive buffer for RF communication, and 4-kbit FeRAM non-volatile memory.

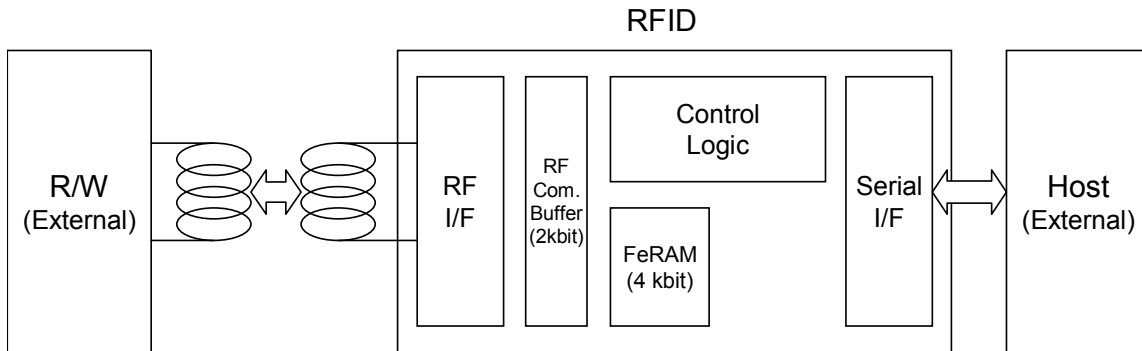

Figure 1-1 Block Diagram

1.3 Operation Mode

This RFID provides three operation modes of RF communication, serial communication, and tunnel. Figure 1-2 gives the overview of each operation mode.

■ RF communication mode

This mode is used for communication between reader/writer and RFID. Reader/writer is the master and RFID is the slave. Key commands are read and write commands to FeRAM of RFID. This mode allows batteryless operations that use only the power supplied from the antenna of reader/writer.

For more information about RF communication mode, see Chapter 4 RF Communication Mode.

■ Serial communication mode

This mode is used for communication between host and RFID. Host is the master and RFID is the slave. Key commands are read and write commands to FeRAM of RFID. This mode requires a power supply to the supply voltage pin (VDD2) of RFID.

For more information about serial communication mode, see Chapter 5 Serial Communication Mode.

■ Tunnel mode

This mode is used for communication between reader/writer and host via RFID. Reader/writer is the master and host is the slave. Key commands are read and write commands to host. This mode requires a power supply to the supply voltage pin (VDD2) of RFID.

For more information about serial communication mode, see Chapter 6 Tunnel Mode.

Additionally, for state transition diagram in each operation mode, see Section 7.2 State Transition Diagram in Operation Mode.

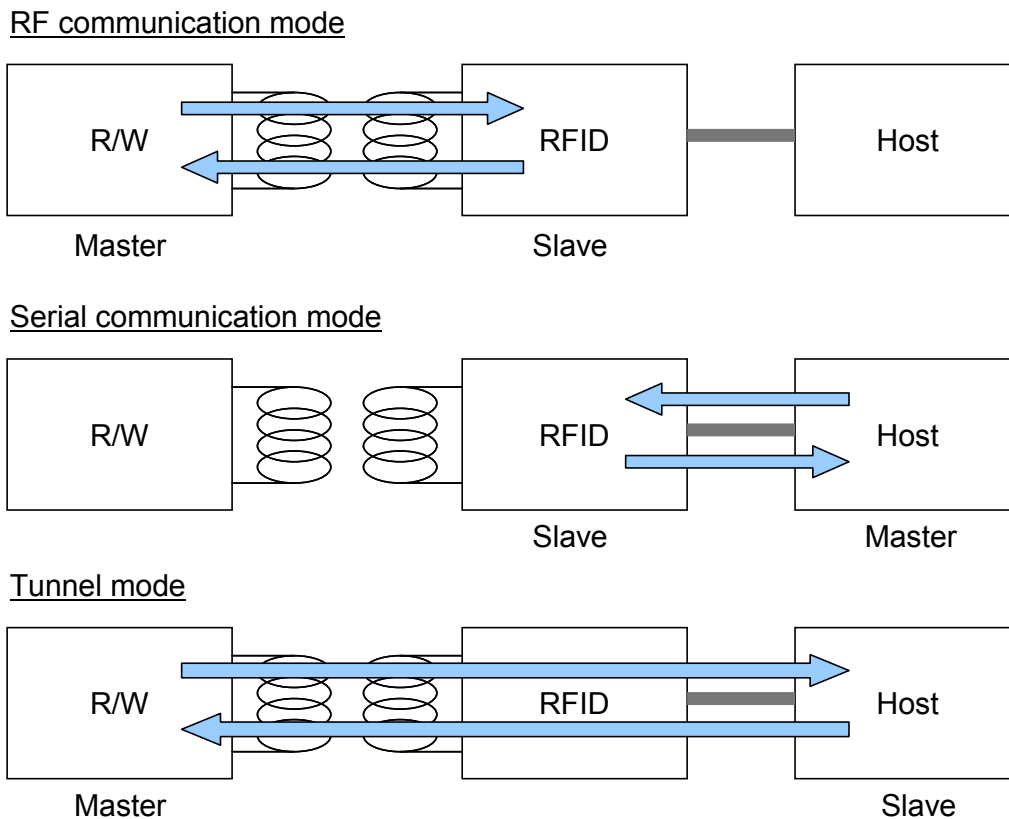

Figure 1-2 Operation Mode

Chapter 2 Pin Descriptions

2.1 List of Pins

Table 2-1 shows a list of pins of this RFID and Figure 2-1 illustrates the pin assignments of this RFID.

Table 2-1 List of Pins

| Pin No. | Name | I/O | 5V tolerant | Output type | Description |
|---------|-------|--------|-------------|-------------|--|
| 1 | NC | - | - | - | Not connected |
| 2 | VB | I/O | - | - | Connected to coil |
| 3 | VDD2 | - | - | - | Serial interface power supply |
| 4 | VDD | - | - | - | Internal digital power supply |
| 5 | VSS | - | - | - | Ground |
| 6 | VDD1 | - | - | - | Internal analog power supply |
| 7 | VA | I/O | - | - | Connected to coil |
| 8 | NC | - | - | - | Not connected |
| 9 | TEST | Input | No | - | Test control |
| 10 | NCLP | - | No | - | Clamp control |
| 11 | RX | Input | Yes | - | Data reception (UART: RX, Clock sync: SCK) |
| 12 | TX3V | I/O | No | Open Drain | Data reception for 3 V (UART: TX, Clock sync: I/O) |
| 13 | TX5V | I/O | Yes | Open Drain | Data reception for 5 V (UART: TX, Clock sync: I/O) |
| 14 | IRQ3V | Output | No | Open Drain | Interrupt request output for 3 V |
| 15 | IRQ5V | Output | Yes | Open Drain | Interrupt request output for 5 V |
| 16 | SEL | Input | No | - | Serial interface selection |

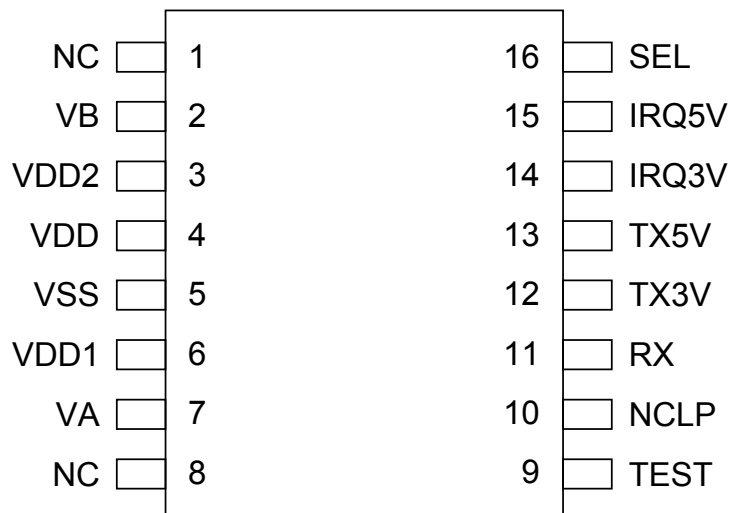

Figure 2-1 Pin Assignments (SSOP16)

2.2 Pin Descriptions

- Coil connection pins (VA, VB)

Used for connecting an antenna coil. Also connect a resonance capacitor for adjusting resonance frequency.

- Ground (VSS)

A reference power supply pin. Connect to the ground of the host CPU.

- Internal analog power supply (VDD1)

An internal analog power supply pin. Connect a capacitor (see the Product Standards for its value) between VDD1 and VSS pins as close as possible to the RFID. It is unnecessary to apply an external power to this pin.

- Internal digital power supply (VDD)

An internal digital power supply pin. Leave this pin open. Connect a capacitor (see the Product Standards for its value) between VDD and VSS pins as close as possible to the RFID. It is unnecessary to apply an external power to this pin.

- Contact power supply VDD2

A contact power supply pin. Apply a high voltage to this pin when communicating data between the host CPU and RFID. Connect a capacitor (see the Product Standards for its value) between VDD2 and VSS pins as close as possible to the RFID.

Additionally, the RFID has a built-in clamp circuit for 5-V operation. When using the circuit, apply a 5-V supply voltage to this pin through a given resistor (see the Product Standards for its value).

- Serial interface select pin (SEL)

Used for selecting serial interfaces. Set the pin to low for UART, and to high for clock synchronous. This pin is 5-V tolerant I/O.

- Data receive pin (RX) [UART: RX; Clock synchronous: SCK]

A data input pin. It is used as RX for UART, and as serial clock input SCK for clock synchronous. This pin is 5-V tolerant I/O.

- Data transmission in 3-V operation (TX3V) [UART: TX; Clock synchronous: I/O]

A data output pin. It is used as TX for UART, and as data I/O for clock synchronous. This pin is open-drain, so should be pulled up. Additionally, this pin is provided for 3-V operation. When not using, leave it open.

- Data transmission in 5-V operation (TX5V) [UART: TX; Clock synchronous: I/O]

A data output pin. It is used as TX for UART, and as data I/O for clock synchronous. This pin is open-drain, so should be pulled up. Additionally, this pin is provided for 5-V operation. When not using, leave it open.

- Interrupt request in 3-V operation (IRQ3V)

An interrupt request output pin. Receiving a command in tunnel mode from external reader/writer generates a low interrupt request signal pulse on this pin. This pin is open-drain, so should be pulled up. Additionally, this pin is provided for 3-V operation. When not using, leave it open.

- Interrupt request in 5-V operation (IRQ5V)

An interrupt request output pin. Receiving a command in tunnel mode from external reader/writer generates a low interrupt request signal pulse on this pin. This pin is open-drain, so should be pulled up. Additionally, this pin is provided for 5-V operation. When not using, leave it open.

- Test control (TEST)

Used in the test mode. Set it to low.

- Clamp control (NCLP)

This pin controls ON/OFF of the clamp circuit connected to the VDD2 pin. Set it to high (OFF) in 3-V

operation. Set it to low (ON) in 5-V operation.

2.3 Connection Example

Several connection examples are shown below.

2.3.1 Using UART and 5 V Power

Figure 2-2 gives an connection example of using UART and 5-V power.

Set SEL to low in UART operation, and set NCLP to low in 5-V operation. With a series resistor connected (see the Product Standards for its value), apply a 5-V supply voltage to VDD2.

This example shows that the host's GPIO controls the RFID's VDD2. In this case, when not using serial communication, turning VDD2 off allows the consumption current of the RFID to be turned off. In addition, it is also possible to supply a voltage to VDD2 directly from the power supply, not from the host's GPIO.

Furthermore, when the host can always receive data from the RFID's TX, an interrupt request (IRQ) is reported from the TX as well, so allowing to omit IRQ connection.

The TX5V and IRQ5V pins are open-drain output. Pull these pins up to the same voltage level as the power supply of the host.

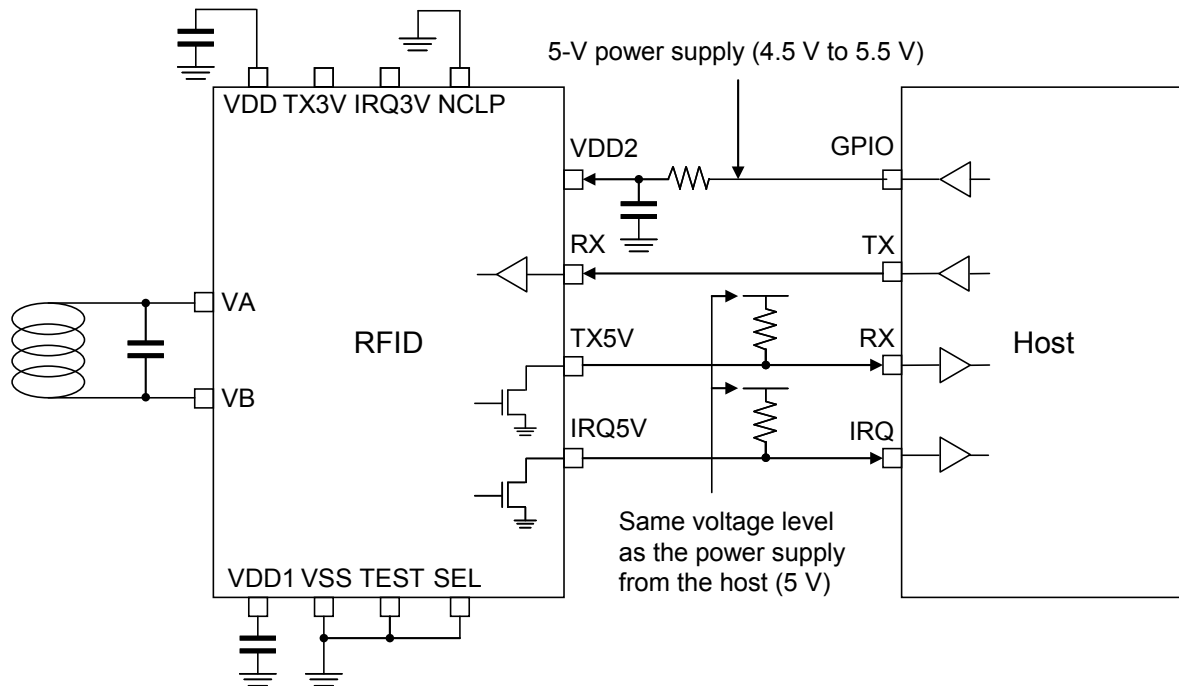

Figure 2-2 Connection Example of UART and 5 V Power Operation

2.3.2 Using UART and 3 V Power

Figure 2-3 gives an connection example of using UART and 3-V power.

Set SEL to low in UART operation, and set NCLP to high in 3-V operation.

This example shows that the host's GPIO controls the RFID's VDD2. In this case, when not using serial communication, turning VDD2 off allows the consumption current of the RFID to be turned off. In addition, it is also possible to supply a voltage to VDD2 directly from the power supply, not from the host's GPIO.

Furthermore, when the host can always receive data from the RFID's TX, an interrupt request (IRQ) is reported from the TX as well, so allowing to omit IRQ signal connection.

The TX3V and IRQ3V pins are open-drain output. Pull these pins up to the same voltage level as VDD2.

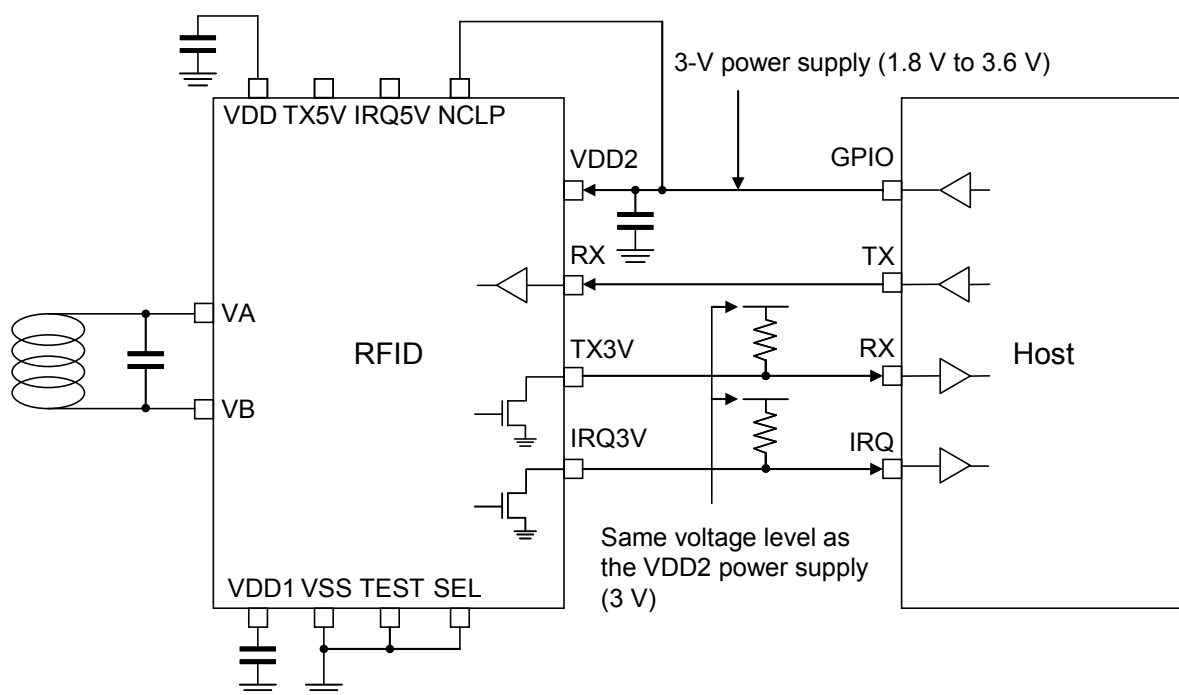

Figure 2-3 Connection Example of UART and 3 V Power Operation

2.3.3 Using Clock Synchronous Mode and 5 V Power

Figure 2-4 gives an connection example of using clock synchronous mode and 5-V power.

Set SEL to high in clock synchronous operation, and set NCLP to low in 5-V operation. With a series resistor connected (see the Product Standards for its value), apply a 5-V supply voltage to VDD2.

This example shows that the host's GPIO controls the RFID's VDD2. In this case, when not using serial communication, turning VDD2 off allows the consumption current of the RFID to be turned off. In addition, it is also possible to supply a voltage to VDD2 directly from the power supply, not from the host's GPIO.

The TX5V (I/O) and IRQ5V pins are open-drain output. Pull these pins up to the same voltage level as the power supply of the host.

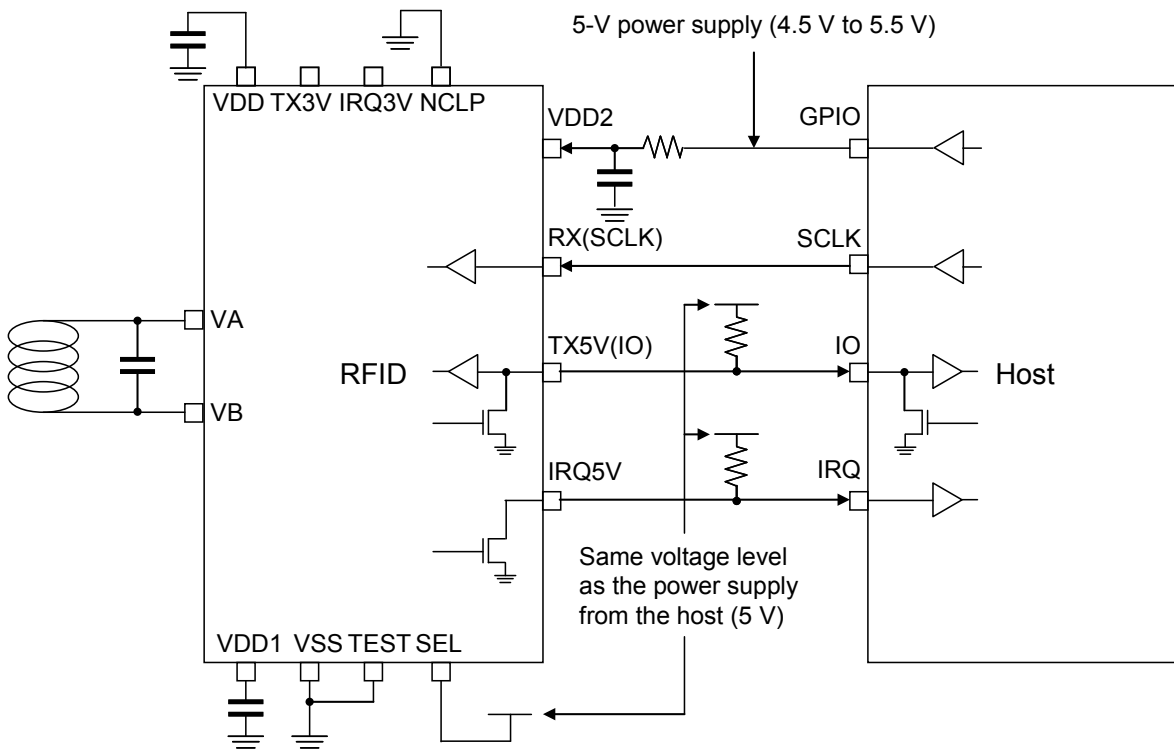

Figure 2-4 Connection Example of Clock Synchronous and 5 V Power Operation

Chapter 3 Memory Map

3.1 Block Configuration

Figure 3-1 illustrates the block configuration of 4-Kbit FeRAM.

This LSI consists of 32 FeRAM blocks. The size of a block is 16 bytes.

The memory consists of two areas: user and system areas.

The system area stores RF-communication-related parameters and memory-access-control-related data, etc.

| Block | Area | Type |
|-------|---------------|-------------|
| 0 | 16Bytes FeRAM | User area |
| 1 | 16Bytes FeRAM | |
| 2 | 16Bytes FeRAM | |
| 3 | 16Bytes FeRAM | |
| ... | ... | |
| 24 | 16Bytes FeRAM | |
| 25 | 16Bytes FeRAM | |
| 26 | 16Bytes FeRAM | |
| 27 | 16Bytes FeRAM | System area |
| 28 | 16Bytes FeRAM | |
| 29 | 16Bytes FeRAM | |
| 30 | 16Bytes FeRAM | |
| 31 | 16Bytes FeRAM | |

Figure 3-1 4-Kbit FeRAM Block Configuration

3.2 Physical Memory Map

Figure 3-2 presents the physical memory map.

| Block | Address | 0x0 | 0x1 | 0x2 | 0x3 | 0x4 | 0x5 | 0x6 | 0x7 | 0x8 | 0x9 | 0xA | 0xB | 0xC | 0xD | 0xE | 0xF |
|-------|---------|-----------|-----|-----|-----|------|-----|-----|-----|----------|-----|-----|-----|-------|-----|--------|-----|
| 0 | 0x0000 | User Area | | | | | | | | | | | | | | | |
| 1 | 0x0010 | User Area | | | | | | | | | | | | | | | |
| 2 | 0x0020 | User Area | | | | | | | | | | | | | | | |
| 3 | 0x0030 | User Area | | | | | | | | | | | | | | | |
| 4 | 0x0040 | User Area | | | | | | | | | | | | | | | |
| 5 | 0x0050 | User Area | | | | | | | | | | | | | | | |
| 6 | 0x0060 | User Area | | | | | | | | | | | | | | | |
| 7 | 0x0070 | User Area | | | | | | | | | | | | | | | |
| 8 | 0x0080 | User Area | | | | | | | | | | | | | | | |
| 9 | 0x0090 | User Area | | | | | | | | | | | | | | | |
| 10 | 0x00A0 | User Area | | | | | | | | | | | | | | | |
| 11 | 0x00B0 | User Area | | | | | | | | | | | | | | | |
| 12 | 0x00C0 | User Area | | | | | | | | | | | | | | | |
| 13 | 0x00D0 | User Area | | | | | | | | | | | | | | | |
| 14 | 0x00E0 | User Area | | | | | | | | | | | | | | | |
| 15 | 0x00F0 | User Area | | | | | | | | | | | | | | | |
| 16 | 0x0100 | User Area | | | | | | | | | | | | | | | |
| 17 | 0x0110 | User Area | | | | | | | | | | | | | | | |
| 18 | 0x0120 | User Area | | | | | | | | | | | | | | | |
| 19 | 0x0130 | User Area | | | | | | | | | | | | | | | |
| 20 | 0x0140 | User Area | | | | | | | | | | | | | | | |
| 21 | 0x0150 | User Area | | | | | | | | | | | | | | | |
| 22 | 0x0160 | User Area | | | | | | | | | | | | | | | |
| 23 | 0x0170 | User Area | | | | | | | | | | | | | | | |
| 24 | 0x0180 | User Area | | | | | | | | | | | | | | | |
| 25 | 0x0190 | User Area | | | | | | | | | | | | | | | |
| 26 | 0x01A0 | User Area | | | | | | | | | | | | | | | |
| 27 | 0x01B0 | CONFIG | | | | | | | | | | | | | | | |
| 28 | 0x01C0 | CONFIG | | | | | | | | | | | | | | | |
| 29 | 0x01D0 | CONFIG | | | | | | | | | | | | | | | |
| 30 | 0x01E0 | SC | IDM | | | | | | PMM | AFI | FWI | HW | | | | | |
| 31 | 0x01F0 | RORF | | | | ROSI | | | | SECURITY | | | | TNPRM | | CONFIG | |

Figure 3-2 Physical Memory Map

3.3 System Area

This section describes the system area.

3.3.1 Parameter Specifications

Each parameter of the system area is shown below.

All addresses and block numbers used in this section correspond to the physical address in Figure 3-2.

■ RORF (4 bytes)

RORF is an area to specify whether read/write or read-only is to be used in accessing the block by memory access commands in RF communication mode. Table 3-1 describes RORF setting, and Table 3-2 shows RORF setting bits and corresponding block numbers. By default, all values are 0. Set all reserved bits to 0.

Table 3-1 RORF Setting

| Value | Meaning |
|-------|------------|
| 0 | Read/Write |
| 1 | Read Only |

Table 3-2 RORF Setting Bits and Corresponding Block Numbers

| Address | Bit 7 | Bit 6 | Bit 5 | Bit 4 | Bit 3 | Bit 2 | Bit 1 | Bit 0 |
|---------|----------|----------|----------|----------|----------|---------|---------|---------|
| 0x01F0 | Block7 | Block6 | Block5 | Block4 | Block3 | Block2 | Block1 | Block0 |
| 0x01F1 | Block15 | Block14 | Block13 | Block12 | Block11 | Block10 | Block9 | Block8 |
| 0x01F2 | Block23 | Block22 | Block21 | Block20 | Block19 | Block18 | Block17 | Block16 |
| 0x01F3 | Reserved | Reserved | Reserved | Reserved | Reserved | Block26 | Block25 | Block24 |

■ ROSI (4 bytes)

ROSI is an area to specify whether read/write or read-only is to be used in accessing the block by memory access commands in serial communication mode. Table 3-3 describes ROSI setting, and Table 3-4 shows ROSI setting bits and corresponding block numbers. By default, all values are 0. Set all reserved bits to 0.

Table 3-3 ROSI Setting

| Value | Meaning |
|-------|------------|
| 0 | Read/Write |
| 1 | Read only |

Table 3-4 ROSI Setting Bits and Corresponding Block Numbers

| Address | Bit 7 | Bit 6 | Bit 5 | Bit 4 | Bit 3 | Bit 2 | Bit 1 | Bit 0 |
|---------|----------|----------|----------|----------|----------|---------|---------|---------|
| 0x01F4 | Block7 | Block6 | Block5 | Block4 | Block3 | Block2 | Block1 | Block0 |
| 0x01F5 | Block15 | Block14 | Block13 | Block12 | Block11 | Block10 | Block9 | Block8 |
| 0x01F6 | Block23 | Block22 | Block21 | Block20 | Block19 | Block18 | Block17 | Block16 |
| 0x01F7 | Reserved | Reserved | Reserved | Reserved | Reserved | Block26 | Block25 | Block24 |

■ SECURITY (4 bytes)

SECURITY is reserved area for future use. By default, all values are 0. Set all bits to 0.

Table 3-5 SECURITY Setting Bit and Corresponding Block Number

| Address | Bit 7 | Bit 6 | Bit 5 | Bit 4 | Bit 3 | Bit 2 | Bit 1 | Bit 0 |
|---------|----------|----------|----------|----------|----------|----------|----------|----------|
| 0x01F8 | Reserved | Reserved | Reserved | Reserved | Reserved | Reserved | Reserved | Reserved |
| 0x01F9 | Reserved | Reserved | Reserved | Reserved | Reserved | Reserved | Reserved | Reserved |
| 0x01FA | Reserved | Reserved | Reserved | Reserved | Reserved | Reserved | Reserved | Reserved |
| 0x01FB | Reserved | Reserved | Reserved | Reserved | Reserved | Reserved | Reserved | Reserved |

■ HW (2 bytes)

HW is an area to store various setting data related to the hardware of this RFID.

Table 3-6 describes the HW parameter. For the setting of the UART data rate UARTSP, see Table 3-7. For the setting of the RF communication protocol RFTYPE, Table 3-8. For the setting of IDM data selection IDMSSEL, see Table 3-9. For the setting of the IRQ output setting IRQSEL, see Table 3-10.

Table 3-6 HW Parameter

| Address | Bit 7 | Bit 6 | Bit 5 | Bit 4 | Bit 3 | Bit 2 | Bit 1 | Bit 0 |
|---------|--------|-------|-------|--------|-------|---------|--------|----------|
| 0x01EE | UARTSP | | | RFTYPE | | IDMSSEL | IRQSEL | Reserved |
| 0x01EF | UARTWT | | | | | | | |

Table 3-7 UARTSP Setting for Specifying UART Data Rate

| Bit 7 | Bit 6 | bit 5 | Meaning |
|-------|-------|-------|--|
| 0 | 0 | 0 | UART data rate: 1200 bps |
| 0 | 0 | 1 | UART data rate: 2400 bps |
| 0 | 1 | 0 | UART data rate: 4800 bps |
| 0 | 1 | 1 | UART data rate: 9600 bps (default) |
| 1 | 0 | 0 | UART data rate: 19200 bps |
| 1 | 0 | 1 | UART data rate: 38400 bps |
| 1 | 1 | 0 | Reserved (When this field is specified, a default setting is applied.) |
| 1 | 1 | 1 | Clock synchronous serial |

Note: When using a clock synchronous serial interface, set UARTSP (bits 7-5) to 111. For more information, see Section 6.3.2.3 Configuring System Area (UARTSP Setting).

Table 3-8 RFTYPE Setting for Selecting RF Communication Protocol

| Bit 4 | Bit 3 | Meaning |
|-------|-------|--|
| 0 | 0 | Use both JISX6319-4 and ISO/IEC14443 TypeB. (Automatic protocol detection) (default) |
| 0 | 1 | Use JISX6319-4 only. (ISO/IEC14443 TypeB interface disabled) |
| 1 | 0 | Use ISO/IEC14443 TypeB only. (JISX6319-4 interface disabled) |
| 1 | 1 | Reserved (When this field is specified, a default setting will be applied.) |

Table 3-9 IDMSSEL Setting for Selecting IDM Data

| Bit 2 | Meaning |
|-------|--|
| 0 | Use the fixed values (All-0) as JISX6319-4 PICC identifier or ISO/IEC14443 TypeB PICC. Values written in the system area are not used. (default) |
| 1 | Use the values written in the system area as JISX6319-4 PICC identifier or ISO/IEC14443 TypeB PICC. |

Table 3-10 IRQSEL Setting for Specifying IRQ Output

| Bit 1 | Meaning |
|-------|---|
| 0 | Does not output IRQ notification code to TX when UART serial interface is used. (default) |
| 1 | Output IRQ notification code to TX when UART serial interface is used. |

UARTWT specifies the minimum wait time until the RFID sends a response after it receives a command from the host while UART is used.

UARTWT is determined using the following formula.

$$\text{Minimum wait time} = T \times \text{UARTWT}$$

T: Typ. 128 μ s ($\pm 25\%$)

UARTWT: 0 to 255: (default: 100; Typ. approximately 12.8 ms)

Note: T includes an error of $\pm 25\%$. set the UARTWT value in consideration of the error.

Note: The minimum wait time might exceed the value specified in this setting, depending on the setting value of UARTWT and command processing.

■ TNPRM (2 bytes)

TNPRM is an area to store various setting data related to timeout.

For more information about this parameter, see Section 6.3.4 Timeout.

Table 3-11 describes the TNPRM parameter.

Table 3-11 TNPRM Parameter

| Address | Bit 7 | Bit 6 | Bit 5 | Bit 4 | Bit 3 | Bit 2 | Bit 1 | Bit 0 |
|---------|-------|-------|-------|-------|----------|-------|----------|----------|
| 0x01FC | QWT | | | | QRTRY | | Reserved | Reserved |
| 0x01FD | AWT | | | | Reserved | | | |

■ QWT

QWT specifies the maximum wait time until the RFID receives a QUERY command from the host after it sends an IRQ to the host during tunnel mode operation.

QWT is determined using the following formula.

$$\text{Maximum wait time for QUERY command} = T \times 2^{\text{QWT}}$$

T: Typ. 1024 μs (±25%)

QWT: 0 to 8 (default: 4; typ. approximately 16 ms)

When this field is set to a value other than 0 to 8, a default value will be applied.

■ QRTRY

QRTRY specifies the maximum number of retries to re-send IRQ when a timeout occurs for the maximum wait time for QUERY command while in tunnel mode operation. It ranges from 0 to 3, and its default value is 1.

When QRTRY is set to 0, the RFID responds with an error without re-sending IRQ.

■ AWT

AWT specifies the maximum wait time until the RFID receives an ANSWER command from the host after it sends a response to the QUERY command to the host during tunnel mode operation.

AWT is determined using the following formula.

$$\text{Maximum wait time for ANSWER command} = T \times 2^{\text{AWT}}$$

T: typ. 1024 μs (±25%)

AWT: 0 to 12 (default: 7; typ. approximately 131 ms)

When this field is set to a value other than 0 to 12, a default value will be applied.

Note: T includes an error of ±25%. set the QWT and AWT values in consideration of the error.

■ SC (2 bytes)

SC is used as the JISX6319-4 system code (2 bytes). For more information about system code, see 4.2.5.1 System Code.

Table 3-12 SC Parameter

| Address | 0x01E0 | 0x01E1 |
|----------------------------------|--------|--------|
| JISX6319-4 system code (2 bytes) | D0 | D1 |
| Default | 0xAA | 0xFF |

■ IDM (8 bytes)

IDM is used as JISX6319-4 PICC (Proximity IC Card) identifier (8 bytes). The PUPI (Pseudo-Unique PICC Identifier) (4 bytes) of ISO/IEC14443 TypeB is shared with the lower 4 bytes of the JISX6319-4 PICC identifier. For information about JISX6319-4 PICC identifier, see Section 4.2.5.2 PICC (Proximity IC Card) Identifier, and for information about ISO/IEC14443 TypeB PUPI, see Section 4.3.8.2 PUPI.

Table 3-13 IDM Parameter

| Address | 0x01E2 | 0x01E3 | 0x01E4 | 0x01E5 | 0x01E6 | 0x1E7 | 0x1E8 | 0x01E9 |
|---|----------|--------|--------|--------|--------|-------|-------|--------|
| JISX6319-4 PICC identifier (8 bytes) | D0 | D1 | D2 | D3 | D4 | D5 | D6 | D7 |
| Default | 0x02 | 0xFE | 0x00 | 0x00 | 0x00 | 0x00 | 0x00 | 0x00 |
| ISO/IEC14443TypeB PUPI (4 bytes) | Reserved | | | | D0 | D1 | D2 | D3 |
| Default | - | - | - | - | 0x00 | 0x00 | 0x00 | 0x00 |

Note: In order to validate the value written in the system area IDM, the HW parameter's IDMSEL must be set to 1. See Table 3-9.

■ PMM (2 bytes)

Of the JISX6319-4 response time descriptor (8 bytes), PMM is an area (2 bytes) to specify maximum wait time for the response to READ/WRITE commands. See Section 4.2.5.3 Response Time Descriptor.

Table 3-14 PMM Parameter

| Address | 0x01EA | 0x01EB |
|--|--------|--------|
| JISX6319-4 Response time descriptor (2 bytes) | D5 | D6 |
| Default | 0xFF | 0xFF |

■ AFI (1 byte)

AFI is an area to specify AFI (Application Family Identifier) of ISO/IEC14443 TypeB. See Section 4.3.8.1 AFI.

Table 3-15 AFI Parameter

| Address | 0x01EC |
|------------------------------------|--------|
| ISO/IEC14443 TypeB AFI (1 byte) | D0 |
| Default | 0x00 |

■ FWI (1 byte)

FWI is an area to specify FWI (Frame Waiting time Integer) of ISO/IEC14443 TypeB. See Section 4.3.8.3 FWI.

Table 3-16 FWI Parameter

| Address | 0x01ED |
|------------------------------------|--------|
| ISO/IEC14443 TypeB FWI (1 byte) | D0 |
| Default | 0xE0 |

■ CONFIG

See the Administrator's Manual.

3.3.2 Enabling System Area

In order to enable parameters in the system area, CFEN (see the Administrator's Manual) of the system area must be set to a valid value. If CFEN is not set to a valid value, a default value defined by each parameter will be applied.

Table 3-17 lists the setting application timings after rewriting parameters in the system area while CFEN is enabled. New parameter setting is applied to RORF, ROSI, and SECURITY immediately after rewriting, and applied to other parameters after turning power supply ON from OFF.

Table 3-17 Parameter Application Timing

| | A timing at which new parameter setting is applied after rewriting parameters when CFEN is enabled. |
|----------|---|
| RORF | Apply immediately after rewrites. |
| ROSI | Apply immediately after rewrites. |
| SECURITY | Apply immediately after rewrites. |
| HW | Apply after turning power ON from OFF following rewrites. |
| TNPRM | Apply after turning power ON from OFF following rewrites. |
| SC | Apply after turning power ON from OFF following rewrites. |
| IDM | Apply after turning power ON from OFF following rewrites. |
| PMM | Apply after turning power ON from OFF following rewrites. |
| AFI | Apply after turning power ON from OFF following rewrites. |
| FWI | Apply after turning power ON from OFF following rewrites. |
| CONFIG | See the Administrator's Manual. |

Note: Power OFF means power supplies from both VDD2 and RF interface are OFF.

3.4 Address Correspondence

Figure 3-3 presents the physical address and the corresponding address of each communication mode.

| Physical address | | Serial communication mode | RF communication mode | | |
|------------------|--------|---------------------------|-----------------------|-----|--------------|
| | | | JISX6319-4 | | ISO/IEC14443 |
| Block0 | 0x0000 | 0x0000 | Block No. 0 | D0 | 0x0000 |
| | 0x0001 | 0x0001 | | D1 | 0x0001 |
| | 0x0002 | 0x0002 | | D2 | 0x0002 |
| | 0x0003 | 0x0003 | | D3 | 0x0003 |
| | 0x0004 | 0x0004 | | D4 | 0x0004 |
| | 0x0005 | 0x0005 | | D5 | 0x0005 |
| | 0x0006 | 0x0006 | | D6 | 0x0006 |
| | 0x0007 | 0x0007 | | D7 | 0x0007 |
| | 0x0008 | 0x0008 | | D8 | 0x0008 |
| | 0x0009 | 0x0009 | | D9 | 0x0009 |
| | 0x000A | 0x000A | | Da | 0x000A |
| | 0x000B | 0x000B | | Db | 0x000B |
| | 0x000C | 0x000C | | Dc | 0x000C |
| | 0x000D | 0x000D | | Dd | 0x000D |
| | 0x000E | 0x000E | | De | 0x000E |
| | 0x000F | 0x000F | | Df | 0x000F |
| Block1 | 0x0010 | 0x0010 | Block No. 1 | D0 | 0x0010 |
| | 0x0011 | 0x0011 | | D1 | 0x0011 |
| | ... | ... | | ... | ... |
| | 0x001E | 0x001E | | De | 0x001E |
| | 0x001F | 0x001F | | Df | 0x001F |
| ... | | | | | |
| Block31 | 0x01F0 | 0x01F0 | Block No. 31 | D0 | 0x01F0 |
| | 0x01F1 | 0x01F1 | | D1 | 0x01F1 |
| | ... | ... | | ... | ... |
| | 0x01FE | 0x01FE | | De | 0x01FE |
| | 0x01FF | 0x01FF | | Df | 0x01FF |

Figure 3-3 Address Correspondence

Chapter 4 RF Communication Mode

4.1 RF Communication Mode Sequence

Figure 4-1 illustrates the sequence in RF communication mode. Each sequence is described below.

SNo.1: A reader/writer sends an RF communication mode command to the RFID.

SNo.2: Once the RFID receives the RF communication mode command described in SNo.1, it processes the command and then sends the result to the reader/writer as the response to the command.

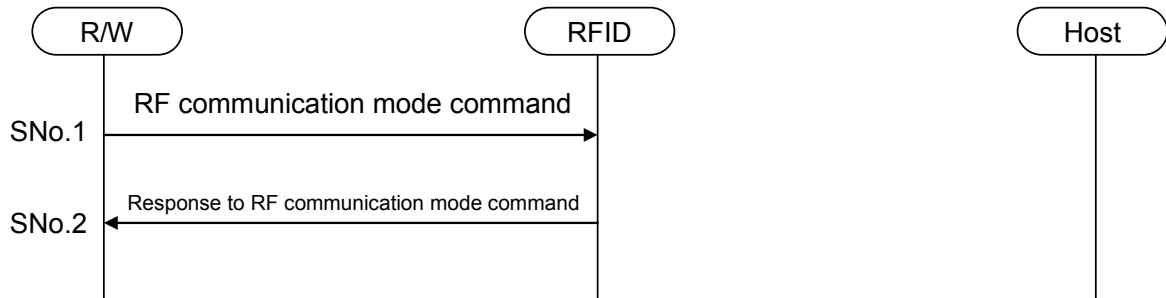

Figure 4-1 RF Communication Mode Sequence

4.2 JISX6319-4 Specification

This section describes the JISX6319-4 specification of this RFID.

4.2.1 Communication Specifications

Table 4-1 shows the JISX6319-4 specification of this RFID.

Table 4-1 JISX6319-4 Communication Specification

| | | |
|----------------------------------|----------|--|
| Carrier frequency | | 13.56 MHz |
| Modulation mode, Bit encoding | R/W→RFID | ASK10%, Manchester encoding |
| | RFID→R/W | Load modulation, Manchester encoding |
| Data rate | | 212 kbps / 424 kbps |
| Character transmission | | <ul style="list-style-type: none"> · MSB-first · Data (8 bits) · No start bit · No parity bit · No stop bit · No spare time between characters |

4.2.2 Frame Format

Figure 4-2 illustrates the JISX6319-4 frame format and Table 4-2 defines the fields.

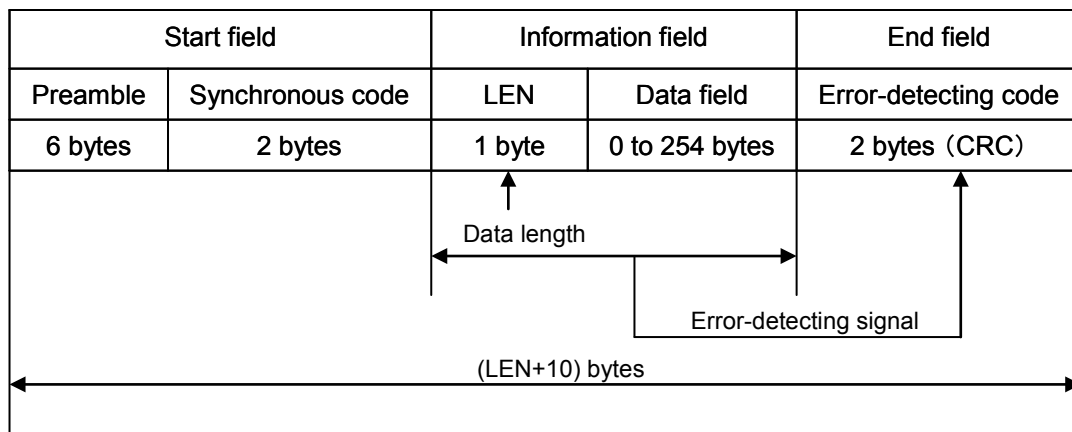

Figure 4-2 JISX6319-4 Frame Format

Table 4-2 JISX6319-4 Field Definition

| Field name | Byte length | Definition |
|----------------------|-------------|---|
| Preamble | 6 | 0x000000000000 |
| Synchronous code | 2 | 0xB24D |
| LEN | 1 | n (data field length) + 1 |
| Data field | n | Command message or Response message |
| Error-detecting code | 2 | Initial value: 0000, Generating polynomial: CRC of $X^{16}+X^{12}+X^5+1$ |

4.2.3 State Transition Diagram

Figure 4-3 shows the state transition diagram for the JIX6319-4 PICC of this RFID.

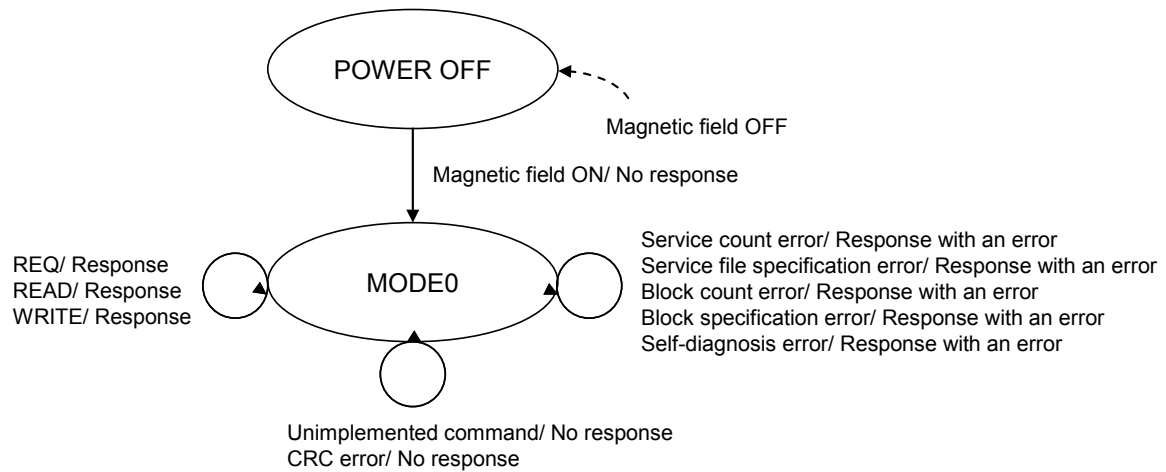

Figure 4-3 State Transition Diagram of JISX6319-4 PICC

4.2.4 Flow Chart

Figure 4-4 gives the flow chart for JIX6319-4 command processing of this RFID.

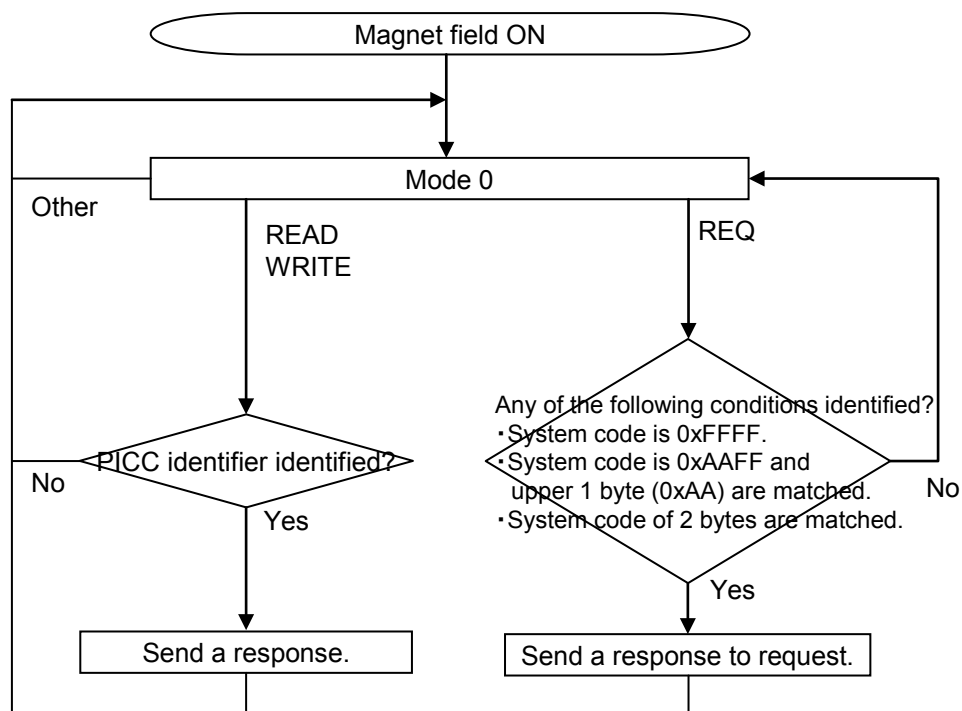

Figure 4-4 JISX6319-4 Flow Chart of Command Processing

4.2.5 Various Settings

This section describes the parameter settings and operation specifications based on JISX6319-4 for this RFID.

4.2.5.1 System Code

System code is a parameter specified by the REQ command that is used to identify the RFID. Figure 4-5 shows the system code. The system code is set by the value of the system area SC for FeRAM.

The response operation to the REQ command by system code is shown in Table 4-3.

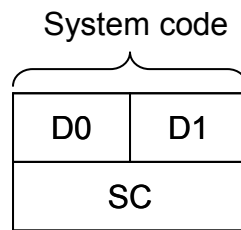

Figure 4-5 System Code

Table 4-3 Response to REQ Command by System Code

| REQ command System code setting value | RFID's response to REQ command |
|---------------------------------------|--|
| 0xFFFF | Responds regardless of the system area SC setting |
| 0xA AFF | When the value of the upper 1 byte of the SC system area is 0xAA, the RFID responds regardless of the value of the lower 1 byte. |
| Other | Responds only when the setting value of the REQ command's system code matches the value specified in the system area SC (and does not respond in other cases). |

4.2.5.2 PICC (Proximity IC Card) Identifier

The PICC (Proximity IC Card) identifier is a data used to identify RFID, and is included in the response to the REQ command. Figure 4-6 illustrates the PICC identifier's format. The PICC identifier (8 bytes) is set in the system area IDM.

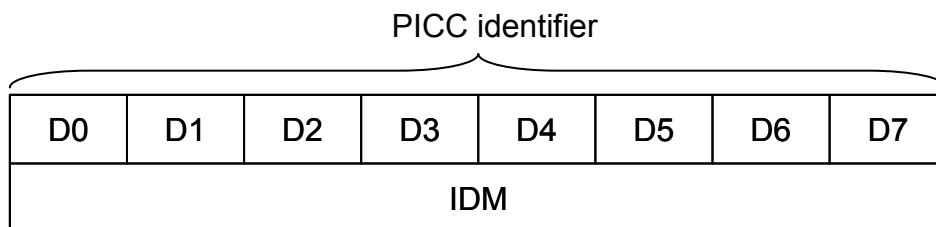

Figure 4-6 PICC Identifier Format

4.2.5.3 Response Time Descriptor

The response time descriptor is used to specify the maximum wait time until the RFID sends a response after reader/writer sends a command, and is included in the response to the REQ command. Figure 4-7 illustrates

the response time descriptor's format. In hardware, D0, D1, and D7 bytes are set to FFh and D2 to D4 bytes are set to 00h. The response time calculation parameters D5 and D6 bytes are the values of the system area. Table 4-4 shows the response time calculation parameter and corresponding command.

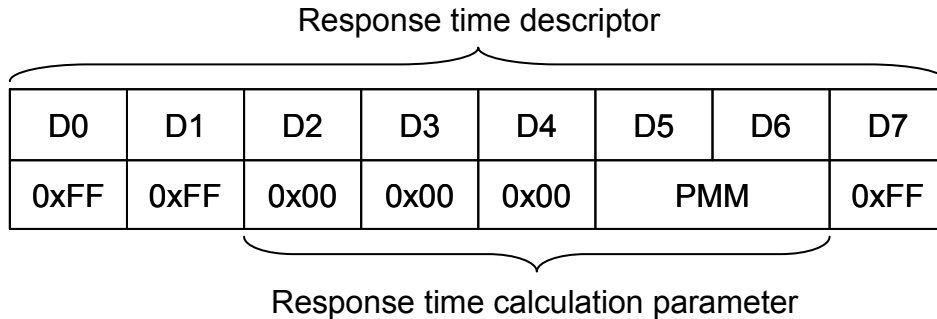

Figure 4-7 Response Time Descriptor Format

Table 4-4 Response Time Calculation Parameter and Corresponding Command

| Response time calculation parameter | Command |
|-------------------------------------|---------|
| D5 | READ |
| D6 | WRITE |

Figure 4-8 shows the response time calculation parameter's format.

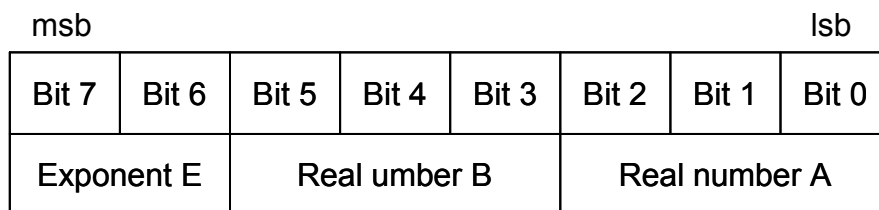

Figure 4-8 Response Time Calculation Parameter Format

The response time is calculated by the following formula:

$$\text{Response time} = T \times [(B + 1) \times n + (A + 1)] \times 4^E$$

T: $256 \times 16/f_c$ (approx. 0.302 ms)

n: No. of blocks or No. of files of command parameter.

4.2.5.4 Anticollision

JISX6319-4 uses the time slot method for anti-collision (prevention of collision). This RFID always responds according to the first slot.

4.2.5.5 Service

This RFID does not implement the concept of service based on JISX6319-4.

However, it is possible to specify multiple services using a command service list. Table 4-5 shows the available maximum number of services. When specifying multiple services in the service list, the values of service list must be set to the same value.

Table 4-5 Maximum Number of Services

| Command | Maximum No. of services |
|---------|-------------------------|
| READ | 15 |
| WRITE | 11 |

Note: The RFID responds with an error when multiple services are not set to the same service file value.

4.2.5.6 Block

JISX6319-4 uses data of 16-byte blocks. Block number is used to specify each block. Figure 4-9 shows the block element of 2 bytes and Figure 4-10 shows the block element of 3 bytes. All of bits 6 to 4 of byte D0 for access mode setting should be set to 0 in this RFID; otherwise the RFID responds with an error.

| | D0 | | | | | | | | D1 | | | | | | | |
|---------------------------|-------|-------|-------|-------|-------------|-------|-------|-------|--------------------------|-------|-------|-------|--------------|-------|-------|-------|
| | msb | | | | lsb | | | | msb | | | | lsb | | | |
| | Bit 7 | Bit 6 | Bit 5 | Bit 4 | Bit 3 | Bit 2 | Bit 1 | Bit 0 | Bit 7 | Bit 6 | Bit 5 | Bit 4 | Bit 3 | Bit 2 | Bit 1 | Bit 0 |
| Definition | - | | | | Access mode | | | | Order of service code | | | | Block number | | | |
| This RFID's setting value | 1 | 0 | 0 | 0 | Don't care | | | | Block number designation | | | | | | | |

Figure 4-9 Block Element of 2 Bytes

| | D0 | | | | | | | | D1 | | | | | | | | D2 | | | | | | | | | | | |
|---------------------------|-------|-------|-------|-------|-------------|-------|-------|-------|--------------------------|-------|-------|-------|--------------|-------|-------|-------|-------|-------|-------|-------|-------|-------|-------|-------|--------------|--|--|--|
| | msb | | | | lsb | | | | msb | | | | lsb | | | | msb | | | | lsb | | | | | | | |
| | Bit 7 | Bit 6 | Bit 5 | Bit 4 | Bit 3 | Bit 2 | Bit 1 | Bit 0 | Bit 7 | Bit 6 | Bit 5 | Bit 4 | Bit 3 | Bit 2 | Bit 1 | Bit 0 | Bit 7 | Bit 6 | Bit 5 | Bit 4 | Bit 3 | Bit 2 | Bit 1 | Bit 0 | | | | |
| Definition | - | | | | Access mode | | | | Order of service code | | | | Block number | | | | | | | | | | | | | | | |
| This RFID's setting value | 0 | 0 | 0 | 0 | Don't care | | | | Block number designation | | | | | | | | 0 | 0 | 0 | 0 | 0 | 0 | 0 | 0 | Mode setting | | | |

Figure 4-10 Block Element of 3 Bytes

This RFID uses a block number to specify tunnel mode and encrypted communication. Table 4-6 shows the mode settings for tunnel mode and encrypted communication. Bits 2 to 0 of byte D2 in 3-byte block element format are used. All of bits 7 to 3 of byte D2 should be set to 0; otherwise the RFID responds with an error.

Table 4-6 Mode Settings

| Block element format | Byte D2 of block No. | | | Meaning |
|----------------------|----------------------|-------|--|--|
| | Bit 2 | Bit 1 | Bit 0 | Communication mode |
| 2 bytes | - | - | - | RF communication mode |
| 3 bytes | 0 | 0 | 0 | Reserved (Setting this field causes an error.) |
| | 0 | 1 | 0 | |
| | 0 | 1 | 1 | |
| | 0 | 0 | 1 | Tunnel mode |
| | 1 | 0 | 0 | |
| | 1 | 1 | 0 | |
| | 1 | 1 | 1 | |
| 1 | 0 | 1 | Reserved (Setting this field causes an error.) | |

Table 4-7 shows the available maximum number of blocks. For READ command, the number is 13 in RF communication mode. The maximum number of blocks for WRITE command depends on the number of services.

Table 4-7 Maximum Number of Blocks

| Command | Communication mode | No. of services | Maximum No. of blocks |
|---------|---------------------------------------|-----------------|-----------------------|
| READ | RF communication mode | 1 to 15 | 13 |
| | Tunnel mode | 1 to 15 | 15 |
| WRITE | RF communication mode, Tunnel mode | 1 to 8 | 12 |
| | | 9 to 11 | 11 |

4.2.5.7 Block List

For tunnel mode, how to specify block list is slightly different from the JISX6319-4 specification. Figure 4-11 shows the block list referenced from this RFID.

(1) RF communication mode: The block number of block list can be set freely. The RFID references to all block numbers.

(2) Tunnel mode: The block number of block list should be set in ascending order. The RFID checks that the block number is set in ascending order and if not, it responds with an error.

Note: When specifying multiple blocks, communication mode (RF communication mode/ tunnel mode) for all blocks should be configured to the same setting; if not, the RFID responds with an error.

Note: When setting block numbers in ascending order, set to 0x00 following the block number 0xFF (and set to 0x01 following 0x00). Mode setting (bits 2 to 0 of byte D2) for all blocks should be set to the same value.

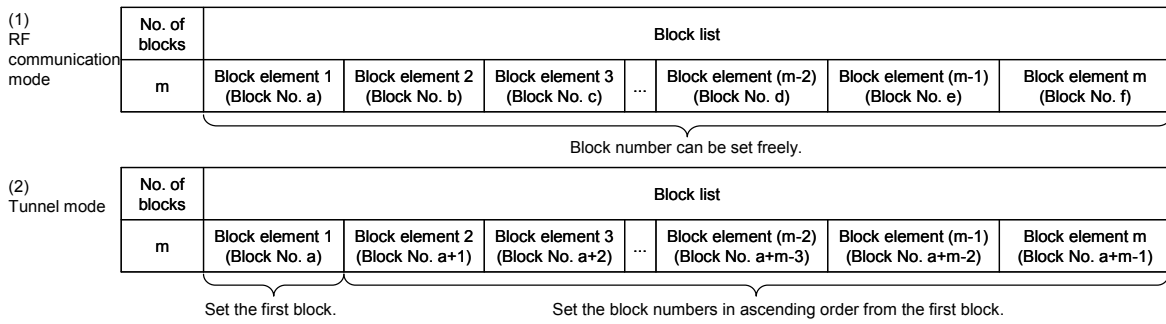

Figure 4-11 Block List Referenced from this RFID

Figure 4-12 shows the block data structure.
All block data are treated as actual data.

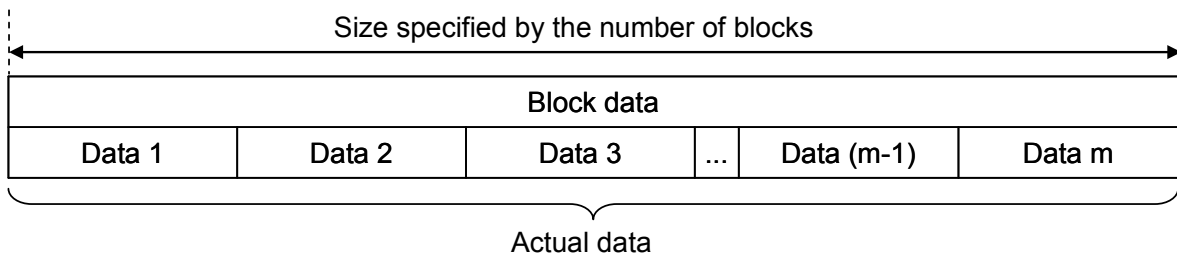

Figure 4-12 Block Data Structure

4.2.5.8 Status Flag

Table 4-8 lists the meanings of status flags.

Table 4-8 Status Flag

| Status flag 1 | Status flag 2 | Meaning | Description |
|---------------|---------------|-------------------------------------|--|
| 0x00 | 0x00 | Normal end | Terminated normally. |
| 0xFF | 0x50 | Tunnel mode error | No response from the host |
| 0xFF | 0x51 | Tunnel mode error | The host responded with an error. |
| 0xFF | 0xA1 | Service count specification error | The number of service files was out of the specification. |
| 0xFF | 0xA2 | Block count specification error (*) | The number of blocks was out of the specification. |
| 0xFF | 0xA3 | Service count specification error | Some settings for multiple service were different from the specification. |
| 0xFF | 0xA5 | Block specification error | <ul style="list-style-type: none"> · Illegal access mode setting (except All-0) · Illegal mode setting (RFU setting) · Block number was specified outside FeRAM. · Ascending order was not used to specify block numbers in tunnel mode. |
| 0xFF | 0x60 | Self-diagnosis error (*) | <ul style="list-style-type: none"> · Write access to FeRAM-Read-Only area (RORF setting) |

(*) For more information about these errors, see the Administrator's Manual.

4.2.6 Command

Table 4-9 lists the JISX6319-4 commands supported by this RFID.

Subsequent sections describe each command in detail.

Table 4-9 JISX6319-4 Command List

| Name | Code | Description |
|-------|------|--|
| REQ | 0x00 | Reader/writer identifies RFID with this command. |
| READ | 0x06 | Reads data of RFID from reader/writer or, in tunnel mode, reads data of the host from reader/writer. |
| WRITE | 0x08 | Writes data to RFID from reader/writer or, in tunnel mode, writes data to the host from reader/writer. |

4.2.6.1 REQ

■ Purpose

Reader/writer identifies RFID with this command.

■ Command message

● Format

| Command code | System code | Request code | Timeslot |
|--------------|-------------|--------------|----------|
| 1 byte | 2 bytes | 1 byte | 1 byte |

● Data field

| Field | Setting | Remarks |
|--------------|--|---|
| Command code | 0x00 | |
| System code | <ul style="list-style-type: none"> 0xFFFF: Identifies all RFIDs. 0xA AFF: Identifies RFID compliant with JISX6319-4, regardless of category. Other: The RFID corresponding to the specified system code responds. | |
| Request code | <ul style="list-style-type: none"> 0x00: No request 0x01: Additional system code request 0x02: Additional transmission protocol capability request | When values other than the values on the left column are set, the RFID treats this field as 0x00 (no request) |
| Timeslot | 0x00: One slot | This RFID always treats this field as 0x00. |

■ Response message

● Format

| Response code | PICC identifier | Response time descriptor | Request data |
|---------------|-----------------|--------------------------|--------------|
| 1 byte | 8 bytes | 8 bytes | 0 or 2 bytes |

● Data field

| Field | Output value | Remarks |
|--------------------------|---|---------|
| Response code | 0x01 | |
| PICC identifier | See 4.2.5.2 PICC (Proximity IC Card) Identifier. | |
| Response time descriptor | See 4.2.5.3 Response Time Descriptor. | |
| Request data | <ul style="list-style-type: none"> Request code 0x00: Request data 0 bytes (No additional data) Request code 0x01: Adds system code. Request code 0x02: 0x0083 (212 kbps, 424 kbps, automatic data rate detection supported) | |

4.2.6.2 READ

■ Purpose

Reads data of RFID from reader/writer or, in tunnel mode, reads data of the host from reader/writer.

■ Command message

● Format

| Command code | PICC identifier | No. of service file identifiers (k) | List of service file identifiers | No. of blocks (m) | Block list |
|--------------|-----------------|-------------------------------------|----------------------------------|-------------------|------------------|
| 1 byte | 8 bytes | 1 byte | 2×k bytes | 1 byte | 2×m or 3×m bytes |

● Data field

| Field | Setting | Remarks |
|-------------------------------------|--|--|
| Command code | 0x06 | |
| PICC identifier | PICC identifier acquired by REQ command described in Section 4.2.6.1 REQ. | |
| No. of service file identifiers (k) | Number of service files Setting range: 0x01(1) to 0x0F(15) | When the range other than the range on the left column is set, the RFID responds with an error. |
| List of service file identifiers | Don't care (Setting example: 0x0900) | When specifying multiple services, the RFID responds with an error if all service files are not set to the same value. |
| No. of blocks (m) | Number of blocks specified in block list Setting range: · RF communication mode: 0x01(1) to 0x0D(13) · Other: 0x01(1) to 0x0F(15) | When the range other than the range on the left column is set, the RFID responds with an error. |
| Block list | Block list of data to be read For information about how to set, see the following: · 4.2.5.6 Block. · 4.2.5.7 Block List. | |

■ Response message

● Format

| Response code | PICC identifier | Status flag 1 | Status flag 2 | No. of blocks (m) | Block data |
|---------------|-----------------|---------------|---------------|-------------------|------------|
| 1 byte | 8 bytes | 1 byte | 1 byte | 1 byte | 16×m byte |

● Data field

| Field | Output value | Remarks |
|-----------------|--|---------|
| Response code | 0x07 | |
| PICC identifier | See 4.2.5.2 PICC (Proximity IC Card) Identifier. | |
| Status flag 1 | See 4.2.5.8 Status Flag. | |

| | | |
|-------------------|---|---|
| Status flag 2 | See 4.2.5.8 Status Flag. | |
| No. of blocks (m) | Number of blocks specified by the command | Omitted when the status is not "Normal end" |
| Block data | See 4.2.5.7 Block List. | Omitted when the status is not "Normal end" |

4.2.6.3 WRITE

■ Purpose

Writes data to RFID from reader/writer or, in tunnel mode, writes data to the host from reader/writer.

■ Command message

● Format

| command code | PICC identifier | No. of service file identifiers (k) | List of service file identifiers | No. of blocks (m) | Block list | Block data |
|--------------|-----------------|-------------------------------------|----------------------------------|-------------------|------------------|------------|
| 1 byte | 8 bytes | 1 byte | 2×k bytes | 1 byte | 2×m or 3×m bytes | 16×m bytes |

● Data field

| Field | Setting | Remarks |
|-------------------------------------|---|--|
| Command code | 0x08 | |
| PICC identifier | PICC identifier acquired by REQ command described in Section 4.2.6.1 | |
| No. of service file identifiers (k) | Number of service files Setting range: 0x01(1) to 0x0B(11) | When the range other than the range on the left column is set, the RFID responds with an error. |
| List of service file identifiers | Don't care (Setting example: 0x0900) | When specifying multiple services, the RFID responds with an error if all service files are not set to the same value. |
| No. of blocks (m) | Number of blocks specified in block list Setting range: <ul style="list-style-type: none"> • No. of service files is 1 to 8: 0x01(1) to 0x0C(12) • No. of service files is 9 to 11: 0x01(1) to 0x0B(11) | When the range other than the range on the left column is set, the RFID responds with an error. |
| Block list | Block list of data to be written For information about how to set, see the following: <ul style="list-style-type: none"> • 4.2.5.6 Block. • 4.2.5.7 Block List. | |
| Block data | See 4.2.5.7 Block List. | |

■ Response message

● Format

| Response code | PICC identifier | Status flag 1 | Status flag 2 |
|---------------|-----------------|---------------|---------------|
| 1 byte | 8 bytes | 1 byte | 1 byte |

● Data field

| Field | Output value | Remarks |
|-----------------|--|---------|
| Response code | 0x09 | |
| PICC identifier | See 4.2.5.2 PICC (Proximity IC Card) Identifier. | |

| | | |
|---------------|--------------------------|--|
| Status flag 1 | See 4.2.5.8 Status Flag. | |
| Status flag 2 | See 4.2.5.8 Status Flag. | |

4.2.7 NDEF

This RFID is based on Type3 Tag of NFC Forum and supports data exchange of a NDEF format. Data exchange of NDEF can be performed by performing a predetermined setup to the user area of FeRAM. Please refer to the applicable written standards of NFC Forum for the details of NDEF.

4.2.7.1 MEMORY MAP

The memory map at the time of NDEF use is shown in Fig. 4-13
 Attribute Information Block is arranged to Block0.
 NDEF file is arranged from Block1 to Block26.

| Block | Address | 0x0 | 0x1 | 0x2 | 0x3 | 0x4 | 0x5 | 0x6 | 0x7 | 0x8 | 0x9 | 0xA | 0xB | 0xC | 0xD | 0xE | 0xF | |
|-------|---------|-------------------------------|-----|-----|-----|-----|-----|-----|-----|-----|-----|-----|-----|-----|-----|-----|-----|----|
| 0 | 0x0000 | Attribute Information Block | | | | | | | | | | | | | | | | |
| 1 | 0x0010 | NDEF data area (message area) | | | | | | | | | | | | | | | | |
| 2 | 0x0020 | | | | | | | | | | | | | | | | | |
| 3 | 0x0030 | | | | | | | | | | | | | | | | | |
| 4 | 0x0040 | | | | | | | | | | | | | | | | | |
| 5 | 0x0050 | | | | | | | | | | | | | | | | | |
| 6 | 0x0060 | | | | | | | | | | | | | | | | | |
| 7 | 0x0070 | | | | | | | | | | | | | | | | | |
| 8 | 0x0080 | | | | | | | | | | | | | | | | | |
| 9 | 0x0090 | | | | | | | | | | | | | | | | | |
| 10 | 0x00A0 | | | | | | | | | | | | | | | | | |
| 11 | 0x00B0 | | | | | | | | | | | | | | | | | |
| 12 | 0x00C0 | | | | | | | | | | | | | | | | | |
| 13 | 0x00D0 | | | | | | | | | | | | | | | | | |
| 14 | 0x00E0 | | | | | | | | | | | | | | | | | |
| 15 | 0x00F0 | | | | | | | | | | | | | | | | | |
| 16 | 0x0100 | | | | | | | | | | | | | | | | | |
| 17 | 0x0110 | | | | | | | | | | | | | | | | | |
| 18 | 0x0120 | | | | | | | | | | | | | | | | | |
| 19 | 0x0130 | | | | | | | | | | | | | | | | | |
| 20 | 0x0140 | | | | | | | | | | | | | | | | | |
| 21 | 0x0150 | | | | | | | | | | | | | | | | | |
| 22 | 0x0160 | | | | | | | | | | | | | | | | | |
| 23 | 0x0170 | | | | | | | | | | | | | | | | | |
| 24 | 0x0180 | | | | | | | | | | | | | | | | | |
| 25 | 0x0190 | | | | | | | | | | | | | | | | | |
| 26 | 0x01A0 | | | | | | | | | | | | | | | | | |
| 27 | 0x01B0 | System Area | | | | | | | | | | | | | | | | |
| 28 | 0x01C0 | | | | | | | | | | | | | | | | | |
| 29 | 0x01D0 | | | | | | | | | | | | | | | | | |
| 30 | 0x01E0 | | | | | | | | | | | | | | | | | SC |
| 31 | 0x01F0 | | | | | | | | | | | | | | | | | |

Fig 4-13 The memory map at the time of NDEF use. (NFC Forum Type3 Tag)

4.2.7.2 Setup of System Code (SC)

In order to use NDEF of Type3 Tag, it is necessary to set value "0x12FC." on a system code (SC).

4.2.7.3 Setup of Attribute Information Block

Attribute Information Block(AIB) is arranged to Block0.

Explanation and the example of a setting of Attribute Information Block (AIB) are shown in Table 4-10.

Table 4-10 The example of a setting of Attribute Information Block (AIB)

| Physical address | Size | Value | Contents | Supplement |
|-------------------|-------|------------|--|---|
| 0x0000 | 1Byte | 0x10 | Mapping Version | Please set up according to the NDEF standard version to apply. |
| 0x0001 | 1Byte | 0x0D | Nbr (The number of the maximum block of one read command) | Please set up 0x0F in this RFID. |
| 0x0002 | 1Byte | 0x0B | Nbw (The number of the maximum block of one write command) | Please set up 0x0B in this RFID. |
| 0x0003 ~0x0004 | 2Byte | 0x001A | Nmaxb (The number of maximum block of NDEF data which can handle this RFID) | |
| 0x0005 ~0x0008 | 4Byte | 0x00000000 | Intact area | Please set 4 bytes of 0x00 to all. |
| 0x0009 | 1Byte | 0x00 | WriteF 0x00 : Write-in completion 0x0F : Under a write-in advance | Please set "0x0F" before the writing of a NDEF message, and Please set "0x00" after all the writing of a NDEF message completed |
| 0x000A | 1Byte | 0x01 | RW-Flag 0x00 : AIB is read-only. 0x01 : Read and write are possible for AIB. | |
| 0x000B ~0x000D | 3Byte | 0x000003 | Ln (NDEF message length) | 0x000003 = 3Byte (he value to a setting example of a setting of Talbe 4-11) |
| 0x000E ~0x000F | 2Byte | 0x0046 | Checksum | The sum of data level to address 0x0000 - 0x000D |

4.2.7.4 NDEF FILE

An empty NDEF file is shown in Table 4-11 as an example of a setting of a NDEF file.

Table 4-11 The example of a setting of a NDEF file (An empty NDEF file)

| Physical address | Size | Value | Contents | Supplement |
|-------------------|-------|----------|--------------|--|
| 0x0010 ~0x0012 | 3Byte | 0xD00000 | NDEF Message | A mentioned value is a value which shows an empty message. |

4.3 ISO/IEC14443 TypeB Specification

This section describes the ISO/IEC14443 TypeB specification.

4.3.1 Communication Specification

Table 4-12 provides the communication specifications of this RFID based on ISO/IEC14443 TypeB.

Table 4-12 ISO/IEC14443 TypeB Communication Specification

| | | |
|--------------------------------|----------|---|
| Carrier frequency | | 13.56 MHz |
| Moduration mode, Bit coding | R/W→RFID | ASK10%, NRZ coding |
| | RFID→R/W | Load modulation, BPSK coding (848 kHz subcarrier) |
| Data rate | | 106 kbps / 212 kbps |
| Character transmission | | <ul style="list-style-type: none"> • LSB-first • Data (8 bits) • Start bit (1 bit) • Stop bit (1 bit) |

4.3.2 Frame Format

Figure 4-14 illustrates the ISO/IEC14443 TypeB frame format. SOF(Start Of Frame) and EOF(End Of Frame) are added to a data field. The maximum size of data field is 256 bytes in this RFID.

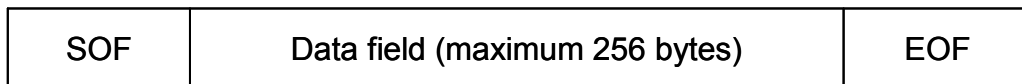

Figure 4-14 ISO/IEC14443 TypeB Frame Format

Additionally, the ISO/IEC14443-4 block format shown in Figure 4-15 is applied to the data field shown in Figure 4-14. This RFID does not support CID and NAD of the first field, so adding them is prohibited.

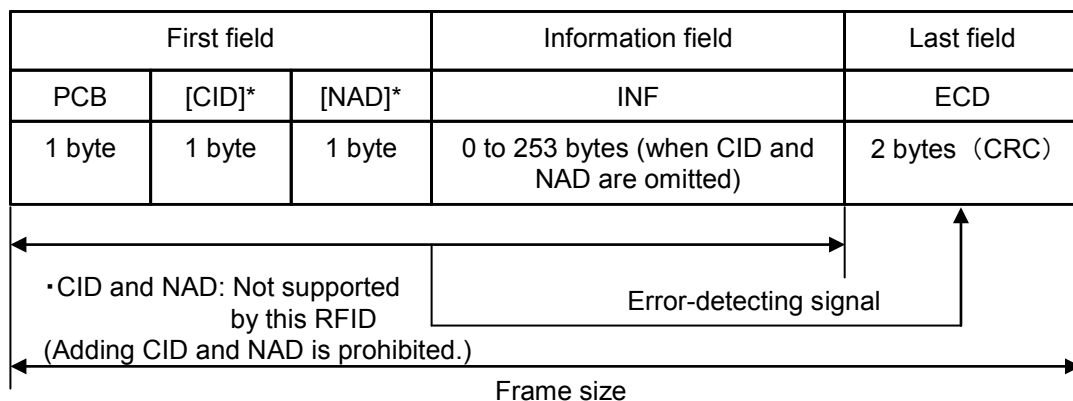

Figure 4-15 ISO/IEC14443-4 Block Format

Table 4-13 ISO/IEC14443-4 Field Definition

| Field name | Byte length | Definition |
|------------|-------------|--|
| PCB | 1 | Protocol Control Byte. See 4.3.3 Protocol Control. |
| CID | 1 | Card Identifier (optional) Used to identify RFID. (Not supported by this RFID; not added.) |
| NAD | 1 | Node Address (optional). Used to establish a logical channel. (Not supported by this RFID; not added.) |
| INF | n | Command message or response message |
| ECD | 2 | See CRC_B ISO/IEC14443-3. |

4.3.3 Protocol Control

PCB (Protocol Control Byte) shown in Figure 4-15 and Table 4-13 is provided for ISO/IEC1443-4 protocol control, and used to send information necessary for data transmission control. This protocol has 3 block types. Table 4-14 lists the definition of block type. This RFID's protocol control specification is given in Table 4-15.

Figure 4-16, Figure 4-17, and Figure 4-18 illustrate I-block, R-block, and S-block codings, respectively.

Table 4-14 Block Type

| Block name | Definition |
|------------|---|
| I-block | Used to send the information of application layer. |
| R-block | Used to send ACK (Acknowledge) or NAK (NegativeAcknowledge). R-block does not include INF field. An R-block corresponding to the last reception block will be sent. |
| S-block | Used to send a control information. The following 2 types are provided: 1. Wait time extension request (WTX) 2. DESELECT command |

Table 4-15 Protocol Control Specification

| Item | Description | By this RFID |
|-----------------------|--|--|
| CID (Card Identifier) | First field parameter of ISO/IEC14443-4 frame (optional). Used to identify RFID. | Not supported |
| NAD (Node Address) | First field parameter of ISO/IEC14443-4 frame (optional). Used to establish a logical channel. | Not supported |
| Chaining | Used to transmit/receive divided data | Supported (however, the size of divisible frame size is 64 bytes or more.) |
| ACK/NCK response | Used to send ACK (Acknowledge) or NAK (NegativeAcknowledge). | Supported |
| WTX | Used to extend the wait time for response from RFID | Not supported |
| DESELECT command | Used to deselect the RFID. | Supported |

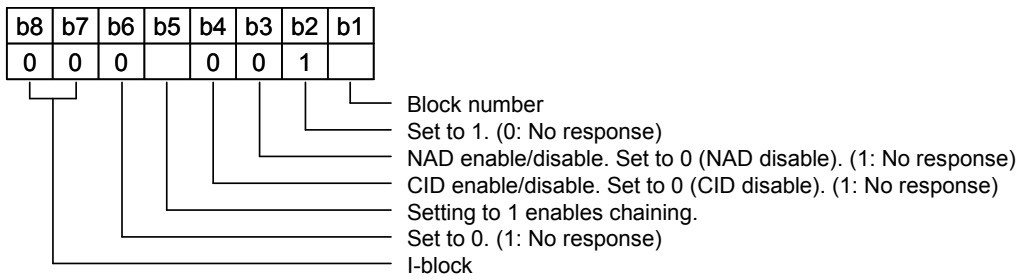

Figure 4-16 I-block Coding

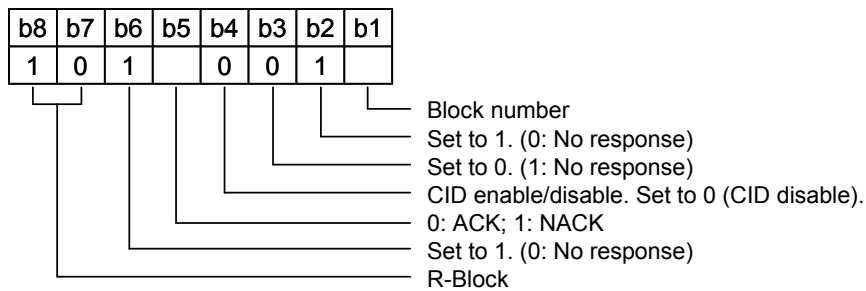

Figure 4-17 R-block Coding

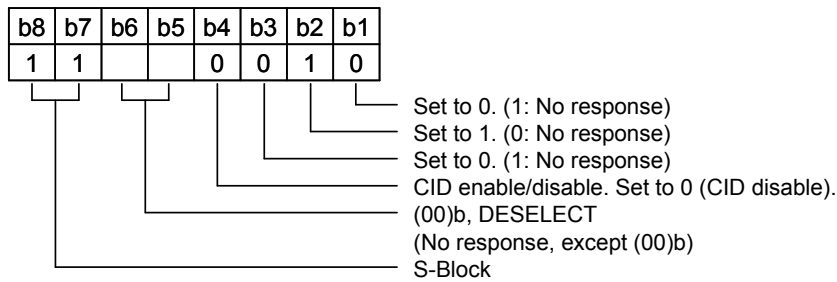

Figure 4-18 S-block Coding

4.3.4 Block Control

The block number rule for ISO/IEC1443-4 I-block is given in Table 4-16. The block control rule and whether to be supported by this RFID are shown in Table 4-17.

Table 4-16 Block Number Rule

| Applied to | No. | Rule |
|-------------------|-------|--|
| Reader/ Writer | RuleA | Set the initial value of reader/writer block number to 0 whenever activating RFID. |
| | RuleB | When I-block or R(ACK) block whose block number is equal to the current one is received, toggle the current block number before sending the block number to RFID. |
| RFID | RuleC | Set the initial value of RFID block number to 1 whenever activating RFID. |
| | RuleD | When I-block is received, toggle the current block number before sending the block. |
| | RuleE | When R(ACK) block whose block number is not equal to the current one is received, RFID toggles the current block number before sending the block. When R(NAK) is received, do not toggle the block number. |

Table 4-17 Block Control Rule

| Applied to | No. | Rule | By this RFID |
|-------------------------------|--------|--|-------------------------|
| Reader/ Writer and RFID | Rule1 | Send the first block from reader/writer. | Supported |
| | Rule2 | When I-block indicating chaining is received, send an affirmative response to the block, with R(ACK) block. | Supported |
| | Rule3 | S-block is used only for pair. Send a response to S(...)block whenever S(...)block is requested. | Only DESELECT supported |
| Reader/ Writer | Rule4 | When an illegal block is received or FWT timeout occurs, send R(NAK) block (except while RFID is in chaining or when S(DESELECT) is executed). | - |
| | Rule5 | When an illegal block is received or FWT timeout occurs while RFID is in chaining, send R(ACK) block. | - |
| | Rule6 | When R(ACK) block is received and its block number is not equal to the block number of reader/writer, re-send the last I-block. | - |
| | Rule7 | When R(ACK) block is received and its block number is equal to the block number of reader/writer, continue chaining. | - |
| | Rule8 | When a response to S(DESELECT) is not sent with no error, re-send S(DESELECT) or ignore the RFID. | - |
| RFID | Rule9 | RFID can send S(WTX) block, instead of I-block or R(ACK) block. | Not supported |
| | Rule10 | When I-block not indicating chaining is not received, send an affirmative response. | Supported |
| | Rule11 | When R(ACK) or R(NAK) block is received and its block number is equal to the block number of RFID, re-send the last I-block. | Supported |
| | Rule12 | When R(NAK) block is received and its block number is not equal to the block number of RFID, send R(ACK). | Supported |
| | Rule13 | When R(ACK) block is received and its block number is not equal to the block number of RFID and RFID is in chaining, continue chaining. | Supported |

4.3.5 Upper Command Format

The upper commands (SELECT, READ, WRITE) are compliant with the APDU (Application Protocol Data Unit) format of ISO/IEC7816-4.

Figure 4-19 shows the command APDU format. Table 4-18 shows the command APDU field definition. Figure 4-20 gives the response APDU format. Table 4-19 gives the response APDU field definition.

The command APDU format shown in Figure 4-19 and the response APDU format shown in Figure 4-20 are configured in the information field INF of the ISO/IEC14443-4 block format shown in Figure 4-15.

| CLA | INS | P1 | P2 | Lc | Data | Le |
|------------|------------------|------------|------------|----------|----------------------|----------|
| Class byte | Instruction byte | Param byte | Param byte | Lc field | Data byte (Lc bytes) | Le field |

Figure 4-19 Command APDU Format

Table 4-18 Command APDU Field Definition

| Field name | Byte length | Definition |
|------------------|-------------|--|
| Class byte | 1 | Fixed to 0x00 |
| Instruction byte | 1 | Instruction code |
| Param byte 1 | 1 | Command parameter |
| Param byte 2 | 1 | Command parameter |
| Lc field | 1 | If a data byte exists in the command APDU, set the byte length of n; if not, omit the data byte. |
| Data byte | n | Data block (can be omitted) |
| Le field | 1 | If a data byte exists in the response APDU, set the byte length; if not, omit the data byte. |

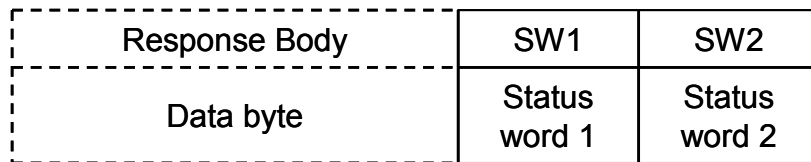

Figure 4-20 Response APDU Format

Table 4-19 Response APDU Field Definition

| Field name | Byte length | Definition |
|---------------|-------------|-----------------------------|
| Data byte | n | Data block (can be omitted) |
| Status word 1 | 1 | Status information |
| Status word 2 | 1 | Status information |

4.3.6 State Transition Diagram

Figure 4-21 provides the state transition diagram for this RFID's operation based on ISO/IEC14443 TypeB.

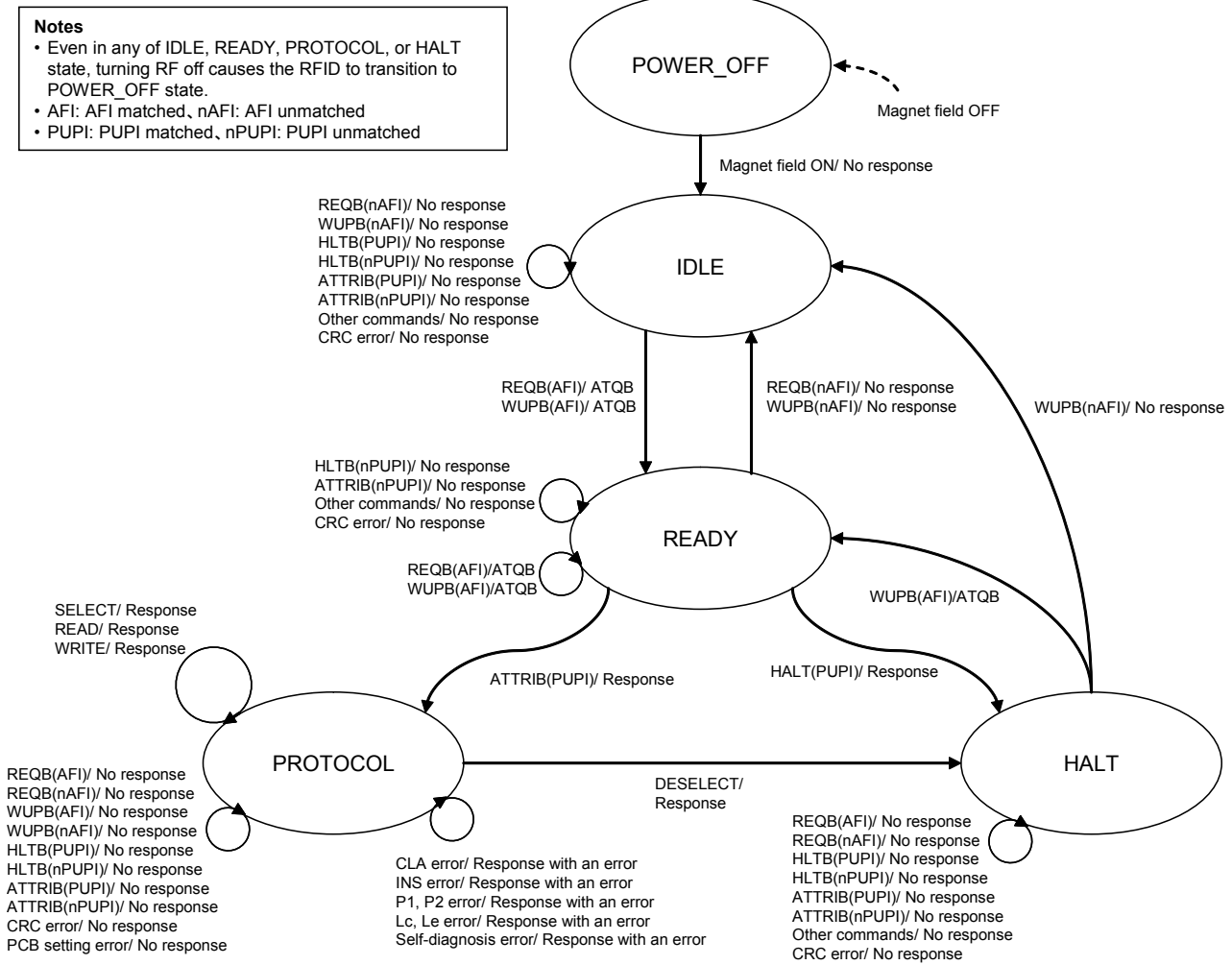

Figure 4-21 State Transition Diagram for Operation Based on ISO/IEC14443 TypeB

4.3.7 Flow Chart

Figure 4-22 illustrates the flow chart for this RFID's command processing based on ISO/IEC14443 TypeB.

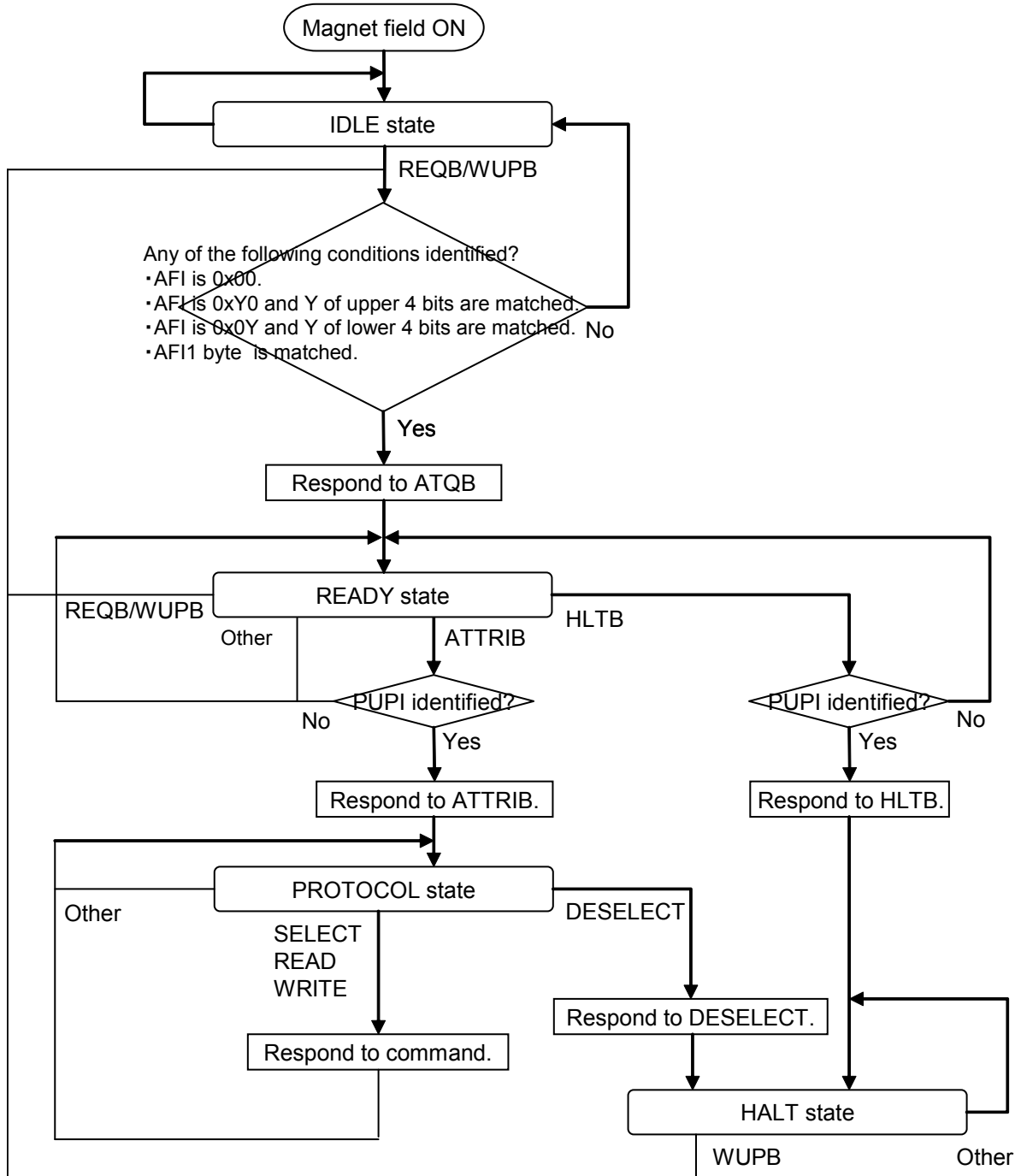

Figure 4-22 Flow Chart of Command Processing Based on ISO/IEC14443 TypeB

4.3.8 Various Settings

This section describes the parameter settings and operation specifications based on ISO/IEC14443 TypeB for this RFID.

4.3.8.1 AFI (Application Family Identifier)

Figure 4-23 shows the format of AFI (Application Family Identifier). The value of AFI is set in the system area AFI.

AFI is a parameter specified by the REQB command. The response operation to REQB command in this RFID is shown in Table 4-20. For information about the setting values for AFI, see ISO/IEC14443-3.



Figure 4-23 AFI Format

Table 4-20 REQB Command Response Operation

| REQB command AFI setting value | RFID's response to REQB command |
|-----------------------------------|--|
| 0x00 | Responds regardless of the system area AFI setting. |
| 0xY0 | Responds when the value Y of the upper 4 bits of the REQB command's AFI is matched. |
| 0x0Y | Responds when the value Y of the lower 4 bits of the REQB command's AFI is matched. |
| Other | Responds only when the setting value of the REQB command's AFI matches the value specified in the system area AFI. |

4.3.8.2 PUPI (Pseudo-Unique PICC Identifier)

Figure 4-24 shows the format of PUPI (Pseudo-Unique PICC Identifier). PUPI is an identifier of PICC (Proximity IC Card). The value of PUPI is set in the lower 4 bytes of the system area IDM.

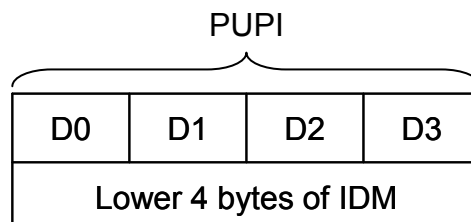

Figure 4-24 PUPI Format

4.3.8.3 FWI (Frame Waiting Time Integer)

Figure 4-25 shows the format of FWI (Frame Waiting time Integer). FWI is used to specify the maximum wait time until the PICC sends a response after receiving a command.

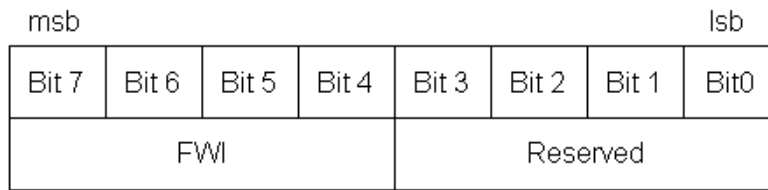

Figure 4-25 FWI Format

The maximum wait time is calculated by the following formula:

$$\text{Maximum wait time} = T \times 2^{\text{FWI}}$$

T: 256 × 16/fc (fc = 13.56 MHz, approx. 0.302 ms)

FWI: 0 to 14 (integer)

The maximum wait time ranges from approximately 0.302 ms (min.; FWI = 0) to approximately 4949 ms (max; FWI = 14).

4.3.8.4 File System

This RFID is compliant with the command specification of ISO/IEC7816-4 standards, but does not implement the file system functionality of the standards. However, in order to ensure the compatibility with communication to reader/writer, the SELECT command to select files is set to "Normal response" when specifying the given parameters. For information about how to set the parameters of the SELECT command, see 4.3.9.4 SELECT.

4.3.8.5 Address

In ISO/IEC14443 TypeB (command is compliant with ISO/IEC7816-4), the addresses of READ and WRITE commands are specified by bytes P1 and P2 of the command APDU. (See 4.3.5 Upper Command Format.)

Figure 4-26 shows the address specification format. Set bit 7 of byte P1 to 0; setting to 1 causes an error.

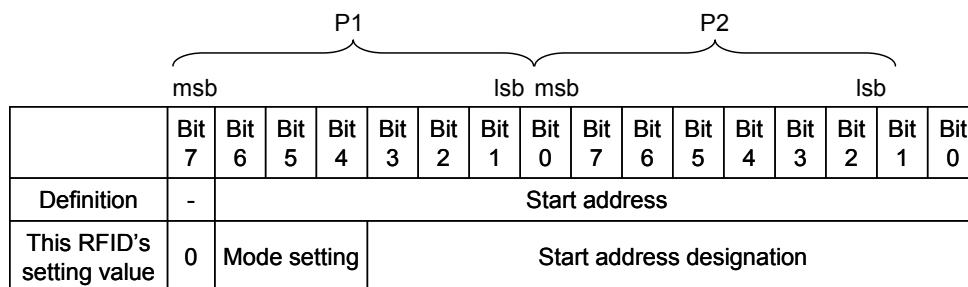

Figure 4-26 Address Specification

This RFID uses address to specify encrypted communication in tunnel mode. Table 4-21 shows mode settings including encrypted communication in tunnel mode with bits 6 to 4 of byte P1.

Table 4-21 Mode Settings

| Byte P1 | | | Meaning |
|---------|-------|-------|--|
| Bit 6 | Bit 5 | Bit 4 | Communication mode |
| 0 | 0 | 0 | RF communication mode |
| 0 | 1 | 0 | Reserved (Setting this field causes an error.) |
| 0 | 1 | 1 | |
| 0 | 0 | 1 | |
| 1 | 0 | 0 | Tunnel mode |
| 1 | 1 | 0 | Reserved (Setting this field causes an error.) |
| 1 | 1 | 1 | |
| 1 | 0 | 1 | |

In addition, Table 4-22 shows the setting unit for address.

Table 4-22 Setting Unit for Address

| |
|--|
| Setting unit for address (n: integer) |
| 1×n bytes |

4.3.8.6 Data

The structure of data block for READ and WRITE commands is shown in Figure 4-27.

All block data are treated as actual data.

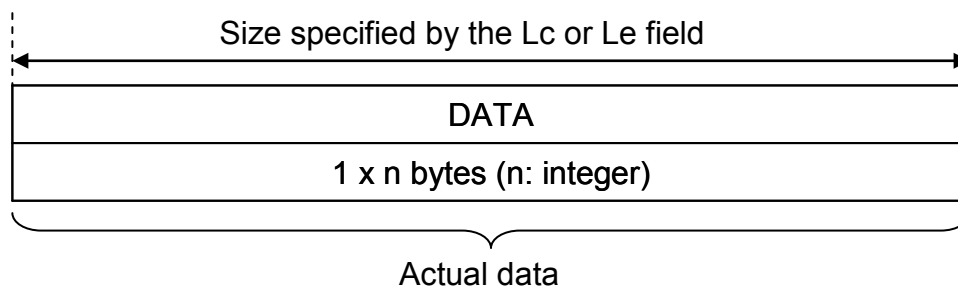

Figure 4-27 Data Block Structure

4.3.8.7 Status Word

Table 4-23 lists the meaning of statuses.

Table 4-23 Status Word

| SW1 | SW2 | Meaning | Description |
|------|------|----------------------------------|--|
| 0x90 | 0x00 | Normal end | Terminated normally. |
| 0x50 | 0x00 | Tunnel mode error | No response from the host |
| 0x51 | 0x00 | Tunnel mode error | The host responded with an error. |
| 0x67 | 0x00 | Lc/Le specification error (*) | • Lc and Le were out of the specification. |
| 0x6A | 0x86 | P1-P2 specification error | • Bit 7 of P1 was not 0. |

| | | | |
|------|------|--------------------------|--|
| | | | <ul style="list-style-type: none">Illegal mode setting (RFU setting)Specified outside FeRAM |
| 0x6D | 0x00 | INS specification error | Illegal INS setting (Specified an unimplemented command) |
| 0x6E | 0x00 | CLA specification error | Illegal CLA setting (except 0x00) |
| 0x6F | 0x00 | Self-diagnosis error (*) | <ul style="list-style-type: none">Write access to FeRAM-Read-Only area (RORF setting) |

(*) For more information about these errors, see the Administrator's Manual.

4.3.9 Command

The commands based on ISO/IEC14443 TypeB supported by this RFID fall into two types:

Commands defined in ISO/IEC14443-3, and APDU commands defined in ISO/IEC7816-4 to be sent in the ISO/IEC14443-4 format.

These commands are shown in Table 4-24 and Table 4-25.

For information about the command format, see Section 4.3.2 Frame Format and Section 4.3.5 Upper Command Format.

Additionally, protocol control such as chaining, ACK/NAK response (R-Block), and DESELECT (S-Block) are also supported. For its detail, see Section 4.3.3 Protocol Control.

Subsequent sections describe each command in detail.

Table 4-24 ISO/IEC14443-3 TypeB Command List

| Name | Code | Description |
|-----------|------|--|
| REQB/WUPB | 0x05 | Identifies the RFID. Used by reader/writer. |
| ATTRIB | 0x1D | Exchanges protocol signal information between reader/writer and RFID, and causes the RFID to transition to the state in which command processing is enabled. |
| HLTB | 0x50 | Transitions the RFID to a HALT state. Used by reader/writer. |

Table 4-25 APDU Command List

| Name | INS | Description |
|--------|------|---|
| SELECT | 0xA4 | Selects the file. (No processing is performed in this RFID.) |
| READ | 0xB0 | Reads the data of RFID from reader/writer. While in tunnel mode, reads the data of the host from reader/writer. |
| WRITE | 0xD6 | Writes a data to RFID from reader/writer. While in tunnel mode, writes a data to the host. |

4.3.9.1 REQB/WUPB

■ Purpose

Identifies the RFID. Used by reader/writer

- REQB is used when the RFID is in IDLE state.
- WUPB is used when the RFID is in HALT state. (It can be also used in IDLE state.)

■ Command message

● Format

| Command code | AFI | PARAM | CRC_B |
|--------------|--------|--------|---------|
| 1 byte | 1 byte | 1 byte | 2 bytes |

● Data field

| Field | Setting | Remarks |
|--------------|---|---|
| Command code | 0x05 | |
| AFI | 0x00: Identifies all RFIDs. 0xY0: RFID whose upper 4 bits are identified responds. 0x0Y: RFID whose lower 4 bits are identified responds. Other than 0x00: RFID corresponding to the specified system code responds. | See 4.3.8.1 AFI (Application Family Identifier). |
| PARAM | 0x00: REQB 0x08: WUPB | This RFID always operates as follows: · Ignores the setting of bits 7-5. · Recognizes the number N of Slots is 1 (always responds with ATQB) even when bits 2-0 are set to any of the values (including PFU). |
| | Bits 7-5 RFU (Set to 000b.) | |
| | Bit 4 0: Extension ATQB not supported 1: Extension ATQB supported | |
| | Bit 3 0: REQB 1: WUPB | |
| | Bit 2-0 000b: Slot count N = 1 001b: Slot count N = 2 010b: Slot count N = 4 011b: Slot count N = 8 100b: Slot count N = 16 101b: RFU 110b: RFU | |
| CRC_B | See CRC_B ISO/IEC14443-3. | |

■ Response message

● Format

| | | | | |
|---------------|---------|------------------|---------------|---------|
| Response code | PUPI | Application data | Protocol info | CRC_B |
| 1 byte | 4 bytes | 4 bytes | 3 bytes | 2 bytes |

● Data field

| Field | Output value | Remarks | |
|------------------|--|--|---|
| response code | 0x50 (ATQB) | | |
| PUPI | See 4.2.5.2 PICC (Proximity IC Card) Identifier. | | |
| Application Data | 0x00000000 | Reserved (treated as proprietary data.) | |
| Protocol Info | 1st byte: 0x91 | For more information about parameters, see ISO/IEC14443-3. | |
| | Bits 7-0 | | Data rate setting: 0x91 <ul style="list-style-type: none"> • R/W→RFID: 106K, 212K bps • RFID→R/W: 106K, 212K bps • R/W→RFID, RFID→R/W (same data rate) |
| | 2nd byte: 0x81 | | |
| | Bits 7-4 | | Maximum frame size of RFID 1000b: 256 bytes |
| | Bits 3-0 | | Protocol type: 0001b <ul style="list-style-type: none"> • RFID is ISO/IEC14443-4 compliant • Minimum reader/writer command wait time (TR2) after RFID responds: 10etu + 32/fs (fs = 848 kHz) |
| | 3rd byte: 0xX0 (X is a value of FWI.) | | |
| | Bits 7-4 | | FWI (Frame Wating time Integer) See 4.3.8.3 FWI (Frame Waiting Time Integer). |
| | Bits 3-2 | | ADC (Application Data Coding) 00b: Proprietary Application Data |
| Bits 1-0 | FO (Frame Option) 00b: NAD, CID not supported | | |
| CRC_B | See CRC_B ISO/IEC14443-3. | | |

4.3.9.2 ATTRIB

■ Purpose

Exchanges protocol signal information between reader/writer and RFID, and causes the RFID to transition to the state in which command processing is enabled.

■ Command message

● Format

| Command code | Identifier | Param1 | Param2 | Param3 | Param4 | CRC_B |
|--------------|------------|--------|--------|--------|--------|---------|
| 1 byte | 4 bytes | 1 byte | 1 byte | 1 byte | 1 byte | 2 bytes |

● Data field

| Field | Setting | Remarks | |
|--------------|--|--|---|
| Command code | 0x1D | | |
| Identifier | Sets PUPI for ATQB response. | | |
| Param1 | 0x00 | This RFID operates with: • bits 1-0 ignored • bits 7-6 set to 00b (when these bits are set to 11b) • bits 5-4 set to 00b (when these bits are set to 11b) This RFID operates with: • Minimum TR0: 64/fs • Minimum TR1: 80/fs • EOF not omitted • SOF not omitted | |
| | Bits 7-6 | | Minimum value of RFID response time to reader/writer command (TR0): (fs = 848 kHz) 00b: 64/fs (106 Kbps), 64/fs (212 Kbps) 01b: 48/fs (106 Kbps), 32/fs (212 Kbps) 10b: 16/fs (106 Kbps), 8/fs (212 Kbps) 11b: RFU |
| | Bits 5-4 | | Minimum value of the time (TR1) until RFID starts data transmission after subcarrier is generated: (fs = 848 kHz) 00b: 80/fs (106 Kbps), 80/fs (212 Kbps) 01b: 64/fs (106 Kbps), 32/fs (212 Kbps) 10b: 16/fs (106 Kbps), 8/fs (212K bps) 11b: RFU |
| | Bit 3 | | 0: Do not omit EOF. 1: Omit EOF. |
| | Bit 2 | | 0: Do not omit SOF. 1: Omit SOF. |
| | Bits 1-0 | RFU (Set to 00b.) | |
| Param2 | 0xXX (For XX, see the settings below.) | • If parameters other than those on the left (communication settings or reader/writer frame size which the RFID does not support) are set, the RFID will generate no response. • If the data rate setting differs between RFID→PCD and | |
| | Bits 7-6 | | RFID→PCD data rate 00b: 106 Kbps 01b: 212 Kbps |
| | Bits 5-4 | | PCD→PICC data rate 00b: 106 Kbps 01b: 212 Kbps |
| | Bits 3-0 | | Maximum receivable frame size of |

| | | | |
|--------|---------------------------|---|--|
| | | reader/writer 1000b: 256 bytes 0111b: 128 bytes 0110b: 96 bytes 0101b: 64 bytes | PCD→RFID, the RFID will generate no response. |
| Param3 | 0x01 | | If parameters other than those on the left are set, the RFID will generate no response. |
| | Bits 7-4 | RFU (Set to 0000b.) | |
| | Bits 3-0 | Set to the same value as that for the protocol type (4 bits) of the ATQB parameter's second byte. | |
| Param4 | 0x00 | | The RFID operates with: · bits 7-4 ignored · no response generated except when bits 3-0 are set to 0000b |
| | Bits 7-4 | RFU (Set to 0000b.) | |
| | Bits 3-0 | 0000b: RFID does not support CID. | |
| CRC_B | See CRC_B ISO/IEC14443-3. | | |

■ Response message

● Format

| | |
|---------------|---------|
| Response code | CRC_B |
| 1 byte | 2 bytes |

● Data field

| Field | Output value | | Remarks |
|---------------|---------------------------|--|--|
| response code | 1st byte: 0x10 | | For more information about parameters, see ISO/IEC14443-3. |
| | Bits 7-4 | MBLI (Maximum Buffer Length Integer) 0001b: 1x of RFID frame size (256 bytes) | |
| | Bits 3-0 | 0000b: RFID does not support CID. | |
| CRC_B | See CRC_B ISO/IEC14443-3. | | |

4.3.9.3 HLTB

- Purpose

Causes the RFID to transition to a HALT state. Used by reader/writer.

- Command message

- Format

| | | |
|--------------|------------|---------|
| Command code | Identifier | CRC_B |
| 1 byte | 4 bytes | 2 bytes |

- Data field

| Field | Setting | Remarks |
|--------------|--|---------|
| Command code | 0x50 | |
| Identifier | Sets the PUPI of the RFID to be set to a HALT state. | |
| CRC_B | See CRC_B ISO/IEC14443-3. | |

- Response message

- Format

| | |
|---------------|---------|
| Response code | CRC_B |
| 1 byte | 2 bytes |

- Data field

| Field | Output value | Remarks |
|---------------|---------------------------|---------|
| Response code | 0x00 | |
| CRC_B | See CRC_B ISO/IEC14443-3. | |

4.3.9.4 SELECT

■ Purpose

Selects the file.

This RFID responds normally when receiving this command, however, it performs no internal processing.

■ Command message

● Format

| CLA | INS | P1 | P2 | Lc | Data |
|--------|--------|--------|--------|--------|---------|
| 1 byte | 1 byte | 1 byte | 1 byte | 1 byte | 2 bytes |

● Data field

| Field | Setting | Remarks |
|-------|---|--|
| CLA | 0x00 | Responds with an error, except 0x00. |
| INS | 0xA4 | |
| P1 | 0x02: Selects EF file. | Responds with an error, except 0x02. |
| P2 | 0x0C: FCI generates no response. | Responds with an error, except 0x0C. |
| Lc | Sets the byte length of the Data block. setting range: 0x02(2) | Responds with an error, except the setting range on the left column. |
| Data | Don't care (This field is set by EF-ID.) | The RFID does not reference to this parameter. |

■ Response message

● Format

| SW1 | SW2 |
|--------|--------|
| 1 byte | 1 byte |

● Data field

| Field | Output value | Remarks |
|-------|--------------------------|---------|
| SW1 | See 4.3.8.7 Status Word. | |
| SW2 | See 4.3.8.7 Status Word. | |

4.3.9.5 READ

■ Purpose

Reads the data of RFID from reader/writer. While in tunnel mode, reads the data of the host from reader/writer.

■ Command message

● Format

| CLA | INS | P1 | P2 | Le |
|--------|--------|--------|--------|--------|
| 1 byte | 1 byte | 1 byte | 1 byte | 1 byte |

● Data field

| Field | Setting | Remarks |
|-------|---|--------------------------------------|
| CLA | 0x00 | Responds with an error, except 0x00. |
| INS | 0xB0 | |
| P1 | Sets the start address to be read. · See 4.3.8.5 Address. | |
| P2 | Sets the start address to be read. · See 4.3.8.5 Address. | |
| Le | Sets the byte length of data to be read. · Setting range: 0x01(1) to 0xFB(251) | |

■ Response message

● Format

| Data | SW1 | SW2 |
|----------------|--------|--------|
| 1 to 251 bytes | 1 byte | 1 byte |

● Data field

| Field | Output value | Remarks |
|-------|--|--|
| Data | Sets the data to be read. · See 4.3.8.6 Data. | Omitted except when status word ends normally. |
| SW1 | See 4.3.8.7 Status Word. | |
| SW2 | See 4.3.8.7 Status Word. | |

4.3.9.6 WRITE

■ Purpose

Writes a data to RFID from reader/writer. While in tunnel mode, writes a data to the host.

■ Command message

● Format

| CLA | INS | P1 | P2 | Lc | Data |
|--------|--------|--------|--------|--------|----------------|
| 1 byte | 1 byte | 1 byte | 1 byte | 1 byte | 1 to 248 bytes |

● Data field

| Field | Setting | Remarks |
|-------|--|--------------------------------------|
| CLA | 0x00 | Responds with an error, except 0x00. |
| INS | 0xD6 | |
| P1 | Sets the start address of data to be written. · 4.3.8.5 Address. | |
| P2 | Sets the start address of data to be written. · 4.3.8.5 Address. | |
| Lc | Sets the byte length of the Data block. · Setting range: 0x01(1) to 0xF8(248) | |
| Data | Sets the data to be written. · 4.3.8.6 Data. | |

■ Response message

● Format

| SW1 | SW2 |
|--------|--------|
| 1 byte | 1 byte |

● Data field

| Field | Output value | Remarks |
|-------|--------------------------|---------|
| SW1 | See 4.3.8.7 Status Word. | |
| SW2 | See 4.3.8.7 Status Word. | |

Chapter 5 Serial Communication Mode

5.1 Serial Communication Mode Sequence

Figure 5-1 illustrates the sequence in serial communication mode. Each sequence is described below.

SNo.1: The host sends a serial communication mode command to the RFID.

SNo.2: Once the RFID receives the serial communication mode command described in SNo.1, it processes the command and then sends the result to the host as the response to the command.

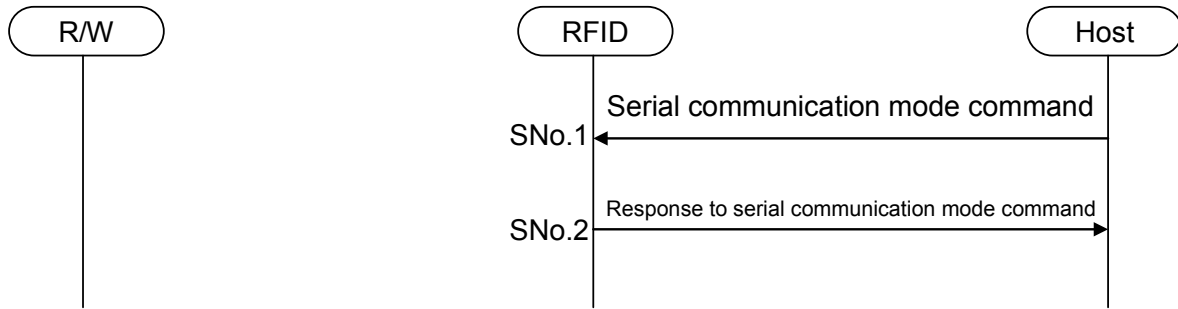

Figure 5-1 Serial Communication Mode Sequence

5.2 UART

This section describes the UART specification.

5.2.1 Communication Specifications

Table 5-1 shows the UART specification of this RFID.

Table 5-1 UART Communication Specification

| | |
|------------------------|--|
| Data transfer method | Asynchronous, half-duplex (Only IRQ notification allows full-duplex) |
| Data rate | 1200 bps, 2400 bps, 4800 bps, 9600 bps, 19200 bps, 38400 bps |
| Character transmission | <ul style="list-style-type: none"> · LSB-first · Data (8 bits) · Start bit (1bit) · Parity bit (1bit, even) · Stop bit (1bit) |
| Other | No flow control signal (RTS/CTS) |

5.2.2 Frame Format

Figure 5-2 illustrates the UART frame format, Table 5-2 defines the fields, and Table 5-3 lists the frame end conditions.

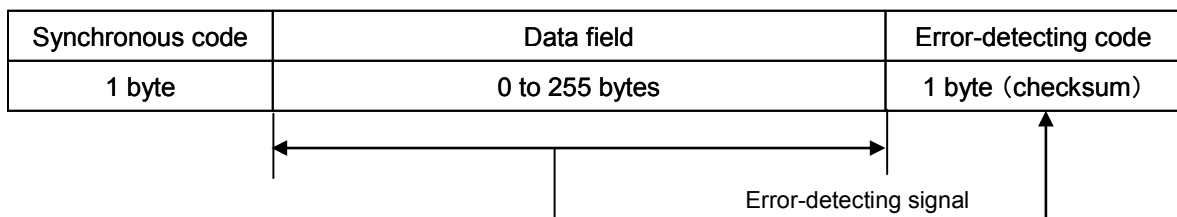

Figure 5-2 Frame Format

Table 5-2 Field Definition

| Field name | Byte length | Definition |
|----------------------|-------------|--|
| Synchronous code | 1 | 0x66 |
| Data field | n | Command message or Response message |
| Error-detecting code | 1 | 2's complement of the sum of data field's data |

Table 5-3 Frame End Conditions

| Data rate | Frame end conditions |
|--------------------|---|
| 9600 bps or less | Frame reception terminates by receiving a checksum (Note) or by receiving no data for 10 ms or more. |
| More than 9600 bps | Frame reception terminates by receiving checksum (Note) or by receiving no data for 3-character length or more. |

(Note) When the frame size can be calculated from the values of command code, data length, and status, receiving a checksum terminates frame reception. When the received command code is not defined or the frame size cannot be calculated (such as ANSWER command in IDLE mode), receiving no data for a given period terminates frame reception.

Note: The IRQ notification code in tunnel mode does not contain synchronous code and error-detecting signal (checksum). (See Section 6.3.1.2 IRQ Notification.)

Note: This RFID makes a timing correction for data rate using the synchronous code (0x66) input from the host. Specifically, it measures and corrects the period between the first falling of start bit and the third falling (starting of 8th bit of data).

5.2.3 Specifying Data Rate

The system area HW of FeRAM is used to specify data rate of UART.

For more information, see ■HW (2 bytes) in Section 3.3 System Area.

5.2.4 Specifying Response Wait Time

This RFID provides a functionality to specify the response wait time until a response is sent after a command from the host is received to a given time or more. The functionality is specified in the system area HW of FeRAM.

For more information, see ■HW (2 bytes) in Section 3.3 System Area.

5.2.5 Status

Table 5-4 lists the meaning of the response status of the RFID.

Table 5-4 RFID Response Status

| Value | Meaning | Description |
|-------|-----------------------------|---|
| 0x05 | Normal end | Terminated normally |
| 0x06 | Checksum error | Checksum, parity, stop bit error |
| 0x16 | Unimplemented command error | The command was unimplemented one. |
| 0x26 | Command parameter error (*) | <ul style="list-style-type: none"> • Address was specified outside FeRAM. • Data length was out of the specification. |
| 0x36 | Tunnel mode error | QUERY and ANSWER commands were issued in IDLE state. |
| 0x46 | Self-diagnosis error | Write access to FeRAM-Read-Only area (ROSI setting) |
| 0x07 | BUSY | RFID command processing in progress |

(*) For more information about these errors, see the Administrator's Manual.

5.2.6 Command

Table 5-5 lists the serial communication mode commands supported by this RFID.

Subsequent sections describe each command in detail.

Table 5-5 Command List in Serial Communication Mode

| Name | Code | Description |
|-------|------|--------------------------------------|
| READ | 0x08 | Reads an RFID data from the host. |
| WRITE | 0x18 | Writes a data to RFID from the host. |

5.2.6.1 READ

■ Purpose

Reads an RFID data from the host.

■ Command message

● Format

| Command code | Start address | Data length n |
|--------------|---------------|---------------|
| 1 byte | 2 bytes | 1 byte |

● Data field

| Field | Setting | Remarks |
|---------------|--|-------------------------------------|
| Command code | 0x08 | |
| Start address | Address at which to start reads | · Byte units · Big endian format |
| Data length n | Size of data to be read · Setting range: 0x01(1) to 0xFE(254) | Byte units |

■ Response message

● Format

| Status | Data |
|--------|----------------|
| 1 byte | 1 to 254 bytes |

● Data field

| Field | Output value | Remarks |
|--------|-------------------|-----------------|
| Status | See 5.2.5 Status. | |
| Data | Data to be read | See Note below. |

Note: If the status of a response message from RFID is not normal (error or busy), data will be omitted.

5.2.6.2 WRITE

- Purpose

Writes a data to RFID from the host.

- Command message

- Format

| Command code | Start address | Data length n | Data |
|--------------|---------------|---------------|----------------|
| 1 byte | 2 bytes | 1 byte | 1 to 251 bytes |

- Data field

| Field | Setting | Remarks |
|---------------|---|---|
| Command code | 0x18 | |
| Start address | Address at which to start writes | <ul style="list-style-type: none"> · Byte units · Big endian format |
| Data length n | Size of data to be written · Setting range: 0x01(1) to 0xFB(251) | Byte units |
| Data | Data to be written | |

- Response message

- Format

| |
|--------|
| Status |
| 1 byte |

- Data field

| Field | Output value | Remarks |
|--------|-------------------|---------|
| Status | See 5.2.5 Status. | |

5.3 Clock Synchronous Serial Communication

This section describes the specification of clock synchronous serial communication.

5.3.1 Communication Specification

Table 5-6 shows this RFID's clock synchronous serial communication specification.

Table 5-6 Clock Synchronous Serial Communication Specification

| | |
|------------------------|--|
| Data transfer method | Clock synchronous, half-duplex |
| Data rate | Up to 1 Mbps |
| I/O timing | <ul style="list-style-type: none"> • Data input at the rising edge of clock • Data output at the falling edge of clock |
| Character transmission | <ul style="list-style-type: none"> • MSB-first • Data (8 bits) • No start bit • No parity bit • No stop bit |

5.3.2 Frame Format

Figure 5-3 illustrates the frame format for clock synchronous serial communication. Table 5-7 shows the field definition.

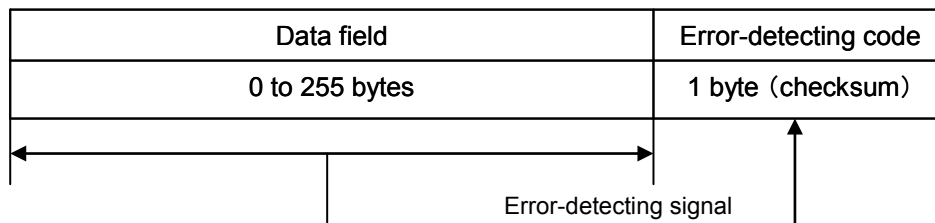

Figure 5-3 Frame Format

Table 5-7 Field Definition

| Name | Byte length | Definition |
|----------------------|-------------|--|
| Data field | n | Command message or Response message |
| Error-detecting code | 1 | 2's complement of the sum of data field's data |

Table 5-8 Frame End Condition

| Receive command | Frame end condition |
|---|--|
| Frame size calculation enable | Frame reception ends when checksum is received. |
| Frame size calculation disable (See Note.) | Frame reception ends when 256-byte data is received. |

(Note) Frame size calculation is disabled in the following cases: (1) Command code is not defined. (2) An ANSWER command is issued in IDLE or TUNNEL_MODE1 state (see Figure 7-4).

Note: When the receive command in Table 5-8 is set to "Frame size calculation disable," in order to meet the frame end condition, dummy data must be added (input) to the existing data so that the sum of those data is just 256 bytes.

Note: This LSI starts serial communication processing, when clock is input to the SCK pin. In the case that the number of clock inputs to the SCK pin is less than 1 Byte within $12\text{ms} \pm 25\%$ since the start of serial communication processing, timeout occurs and the communication status is initialized.

5.3.3 Time Chart

Figure 5-4 shows the time chart when clock synchronous serial is used.

t0: The host inputs a clock to the SCK pin and a command data to I/O pins. Pull the IRQ pin up to high.

t1: The host stops the clock input to the SCK pin after inputting command data. The RFID executes command processing internally.

t2: Once the internal command processing is completed, the RFID outputs low to the IRQ pin to send a response.

t3: The host detects the low output of the IRQ pin and inputs a clock to the SCK pin. The RFID outputs a response data in sync with the clock input. The RFID stops low output to the IRQ pin once the clock input starts.

The host stops the clock after the response data reception is completed.

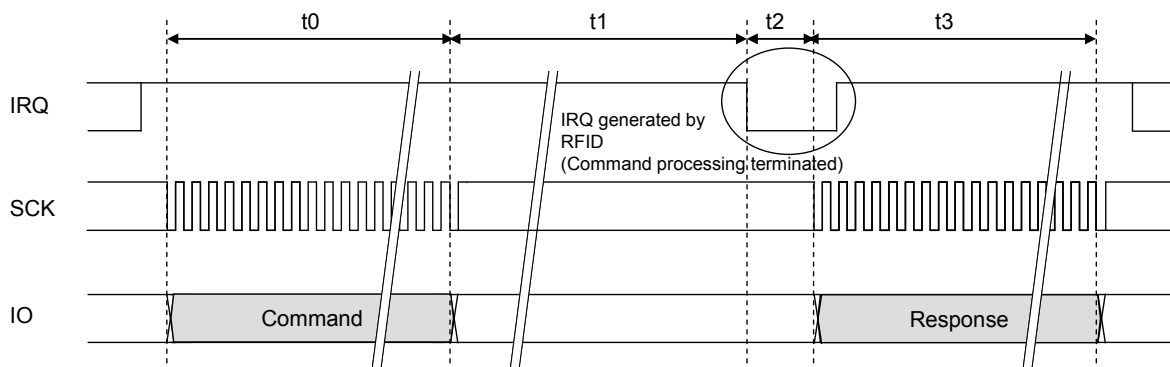

Figure 5-4 Time Chart

5.3.4 Status

The specification of status is the same as that of UART. See Section 5.2.5 Status.

5.3.5 Command

The specification of command is the same as UART. See Section 5.2.6 Command.

6.1 Tunnel Mode Sequence

This section describes the sequence of tunnel mode, which is shown in Figure 6-1.

SNo.1: Reader/writer sends a tunnel mode command to RFID.

SNo.2: RFID receives the tunnel mode command and issues an interrupt request (IRQ) to the host.

SNo.3: If VDD2 is not applied, the host applies VDD2.

SNo.4: The host sends a QUERY command (inquiry) to RFID.

SNo.5: RFID sends a response to the QUERY command to the host. The response includes data of the tunnel mode command in step SNo.1.

SNo.6: The host sends an ANSWER command (notification of the result) to RFID. The command includes data to be sent to reader/writer.

SNo.7: RFID receives the ANSWER command and sends a response (processing result; Normal end or Error) to the command to the host.

SNo.8: After sending the response to the ANSWER command in step SNo.7, RFID sends the data of the ANSWER command to reader/writer as a tunnel mode response.

For more information about tunnel mode operation, see Section 7.2 State Transition Diagram in Operation Mode, Section 7.3 Flow Chart in Tunnel Mode, or other related section. Flow Chart in

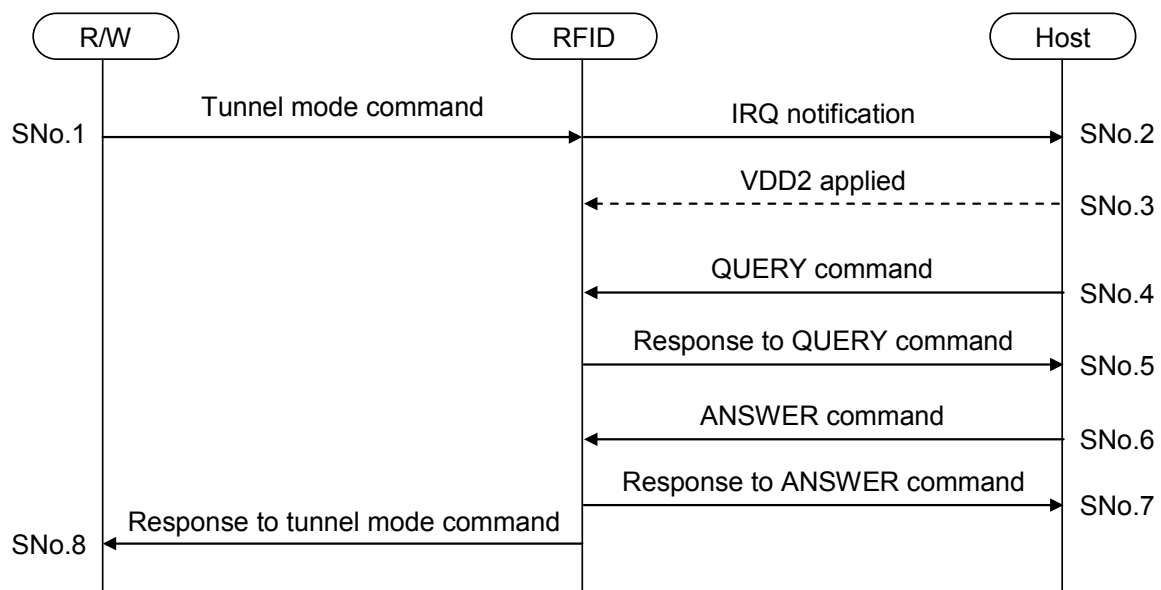

Figure 6-1 Tunnel Mode Sequence

6.2 Communication between Reader/Writer and RFID

This section describes the communication between Reader/Writer and RFID in tunnel mode, based on JISX6319-4 and ISO/IEC14443 TypeB.

6.2.1 Using JISX6319-4

READ and WRITE commands, same as those of RF communication mode, are used.

Use the given bits corresponding to the block number to set the tunnel mode commands. For more information, see Section 4.2.5.6 Block.

For information on how to set block list and block data, see Section 4.2.5.7 Block List.

6.2.2 Using ISO/IEC14443

READ and WRITE commands, same as those of RF communication mode, are used.

Use the given bits of address (P1, P2) to set the tunnel mode commands. For more information, see Section 4.3.8.5 Address.

For information on how to set data, see Section 4.3.8.6 Data.

6.3 Communication between Host and RFID

This section describes the UART communication between the host and RFID in tunnel mode.

6.3.1 .Using UART

The specification when using UART is described below.

6.3.1.1 Communication Specification

The specification for UART communication is the same as that for serial communication mode. See Section 5.2 UART.

QUERY and ANSWER commands are provided only for tunnel mode. For more information about commands, see Section 6.4 Command.

6.3.1.2 IRQ Notification

Once this RFID receives a tunnel mode command from reader/writer, it send an IRQ to the host.

When UART is used, IRQ is output from the IRQ pin. It is also possible to output it from the TX pin by setting the system area HW parameter IRQSEL. For more information about IRQSEL, see ■HW (2 bytes) in Section 3.3 System Area.

Figure 6-2 shows the IRQ waveform when IRQ is not sent from the TX pin (IRQSEL = 0).

IRQ signal is a pulse of 1.28 ms \pm 25%. When the host receives an IRQ and detects that the supply voltage VDD2 is not applied, it applies VDD2 and sends a QUERY command to the RFID. The RFID can receive RX of UART at the falling edge of IRQ.

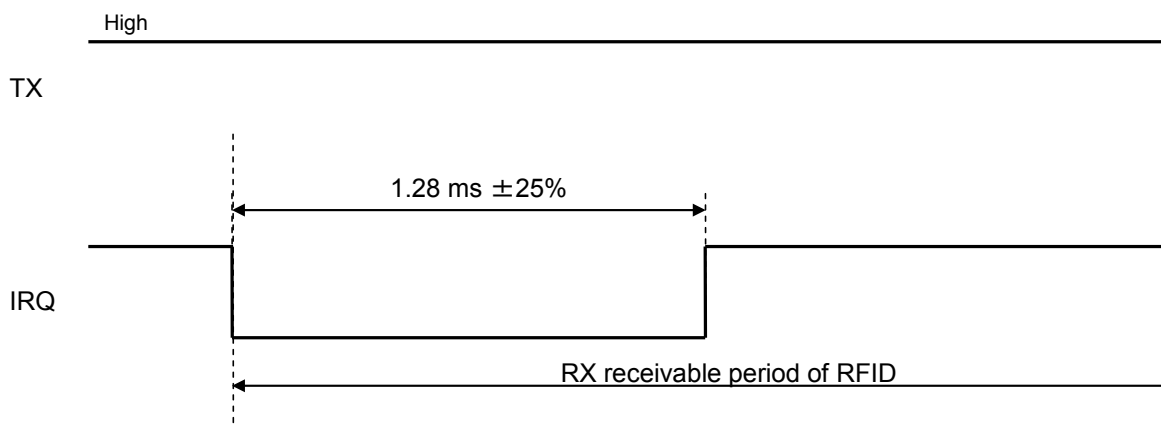

Figure 6-2 UART Signal Waveform When Sending IRQ (IRQSEL = 0)

Next, for IRQ notification from the TX pin (IRQSEL = 1), Figure 6-3 shows IRQ waveform and Table 6-1 shows IRQ code. The RFID's TX pin outputs the notification code 0xFE and IRQ pin outputs a low pulse of 1.28 ms \pm 25% from the timing of bit 2 of TX. The IRQ code of TX does not contain checksum.

When the host receives an IRQ and detects that the supply voltage VDD2 is not applied, it applies VDD2 and sends a QUERY command to the RFID. At this time, the RFID can receive RX (full-duplex communication enabled) immediately after TX and IRQ transition to low. Full-duplex communication is enabled only for IRQ notification.

In addition, if the RFID does not receive a QUERY command from the host even when the maximum wait time for QUERY command specified in the system area QWT elapses after the IRQ pin outputs low, it detects a timeout. For more information, see Section 7.3 Flow Chart in Tunnel Mode. Flow Chart in

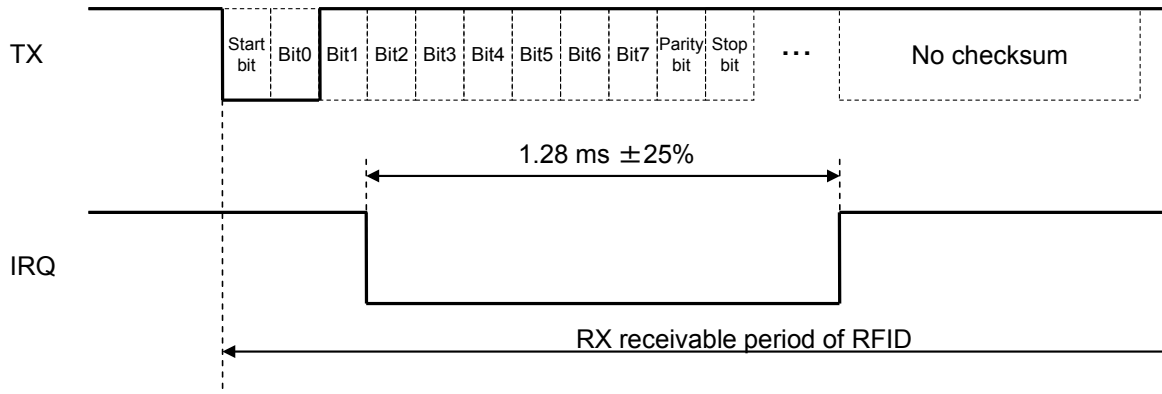

Figure 6-3 UART Signal Waveform When sending IRQ (IRQSEL = 1)

Table 6-1 IRQ Notification Code

| | |
|--------------|--------|
| Size | 1 byte |
| Output value | 0xFE |

6.3.2 Using Clock Synchronous Serial

The specification when using clock synchronous serial is described below.

6.3.2.1 Communication Specification

The specification for clock synchronous serial communication is the same as that for serial communication mode. See Section 5.3 Clock Synchronous Serial Communication.

QUERY and ANSWER commands are provided only for tunnel mode. For more information about commands, see Section 6.4 Command.

6.3.2.2 IRQ Notification

Once this RFID receives a tunnel mode command from reader/writer, it send an IRQ to the host.

When clock synchronous serial interface is used, IRQ is output only from the IRQ pin.

Figure 6-4 shows the IRQ waveform for clock synchronous serial.

The RFID outputs low to the IRQ pin. When the host detects IRQ = L and detects that the supply voltage VDD2 is not applied, it applies VDD2 and then inputs a clock to the SCK pin and at the same time sends a QUERY command to the RFID. Once the RFID detects that a clock is input to the SCK pin, it stops low output to the IRQ pin.

In addition, if the RFID does not receive a QUERY command from the host even when the maximum wait time for QUERY command specified in the system area QWT elapses after the IRQ pin outputs low, it detects a timeout. For clock synchronous, retry of sending IRQ is not performed. For more information, see Section 7.3 Flow Chart in Tunnel Mode.

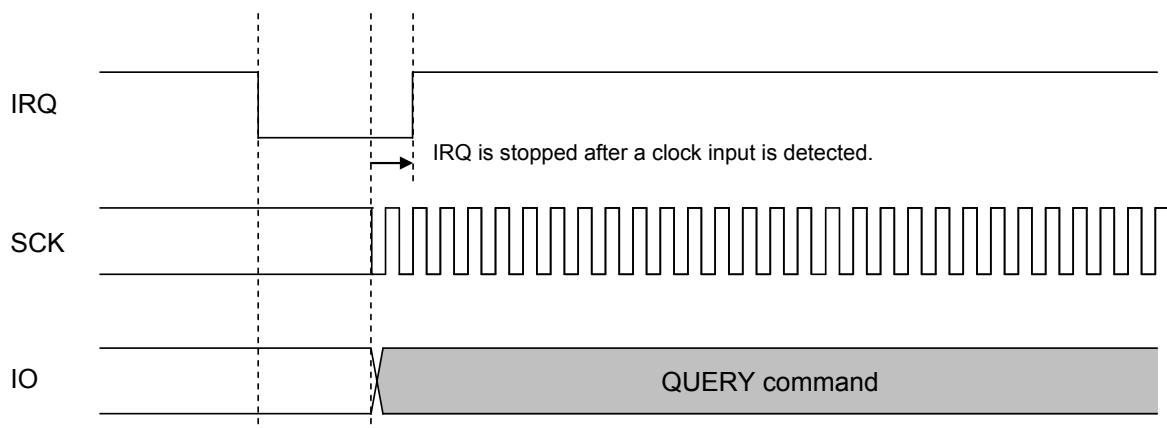

Figure 6-4 Clock Synchronous Serial IRQ Waveform

6.3.2.3 Configuring System Area (UARTSP Setting)

For IRQ notification in tunnel mode command reception, in order to support the case that VDD2 is not applied (SEL pin is disabled), set bits 7, 6, and 5 of the system area HW (2 bytes) parameter UARTSP to 111 when using clock synchronous.

Table 6-2 QUERY Response Mode

| VDD2 state | Serial interface selection (UART or Clock synchronous) |
|-------------|--|
| Applied | Use the SEL pin. |
| Not applied | Use the UARTSP setting. |

6.3.3 Response to QUERY Command

When a response to QUERY command in tunnel mode is sent, the RFID reports the content of the command from reader/writer to the host.

The address setting for response to QUERY is shown in Figure 6-5.

Bit 7 of upper byte is fixed to 0. Bits 6 and 4 indicate mode.

Table 6-3 shows the meaning of mode of upper byte bits 5 and 4. This bit indicates whether the communication in tunnel mode is plaintext (unencrypted) or encrypted (private or family key).

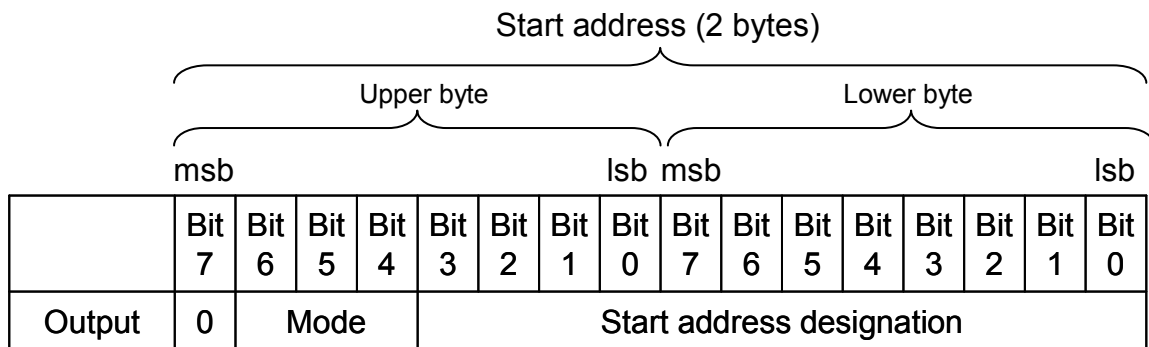

Figure 6-5 Address Setting for Response to QUERY Command

Table 6-3 QUERY Response Mode

| Upper byte | | | Meaning |
|------------|-------|-------|-------------|
| Bit 6 | Bit 5 | Bit 4 | |
| 1 | 0 | 0 | Tunnel mode |
| Others | | | Reserved |

6.3.4 Timeout

In tunnel mode command processing for communication between host and RFID, a timeout processing is applied if the host sends no response to QUERY and ANSWER commands.

Figure 6-6 shows the wait time for commands in tunnel mode.

Subsequent section describes the wait time for QUERY and ANSWER commands.

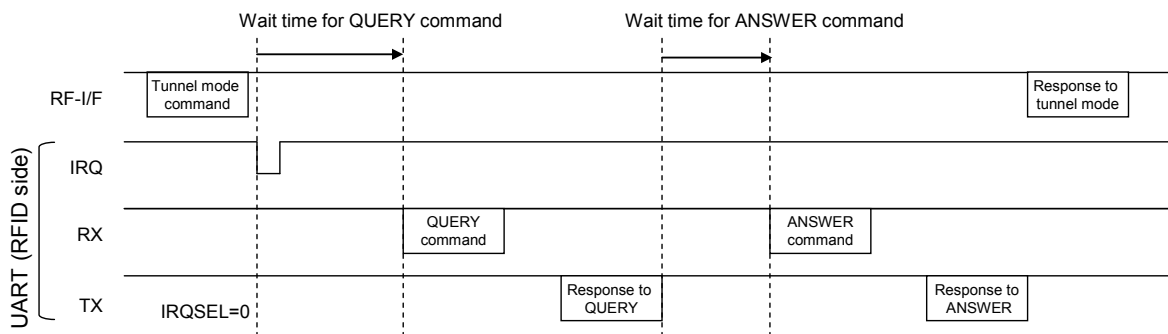

Figure 6-6 Wait Time for Commands

Note: In timeout measurement processing for UART, the start of command is detected at the start of data field, not the start of synchronous code.

6.3.4.1 Wait Time for QUERY Command

The time sequence (QRTRY = 1) for timeout of waiting QUERY command (no response from the host) is shown in Figure 6-7. The measurement of timeout starts when the state of IRQ pin changes to low from high. When UART is used, a timeout time is the longer of QWT setting time or UARTWT setting time.

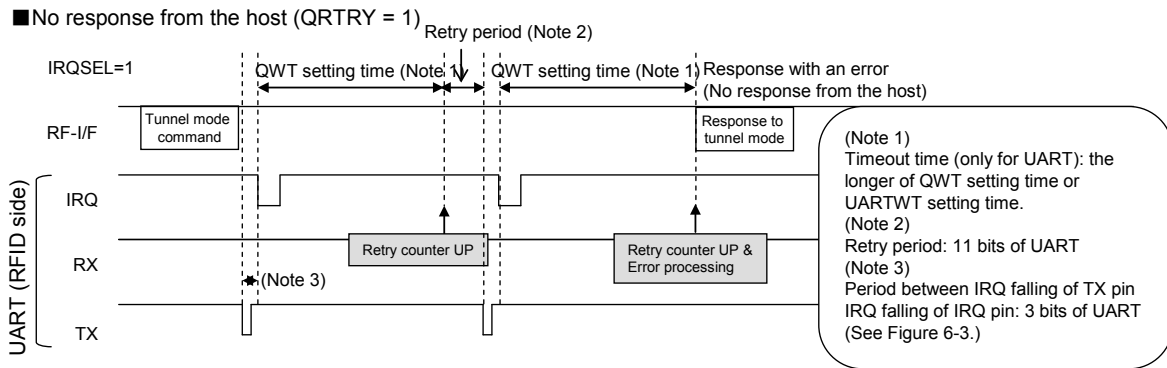

Figure 6-7 Timeout of Waiting for QUERY Command (No Response from the Host)

Next, the time sequence when the RFID receives a command other than QUERY from the host while it waits a QUERY command is shown in Figure 6-8. In this case, the retry counter increases by receiving a command other than QUERY.

For more information, see Section 7.3 Flow Chart in Tunnel Mode. Flow Chart in

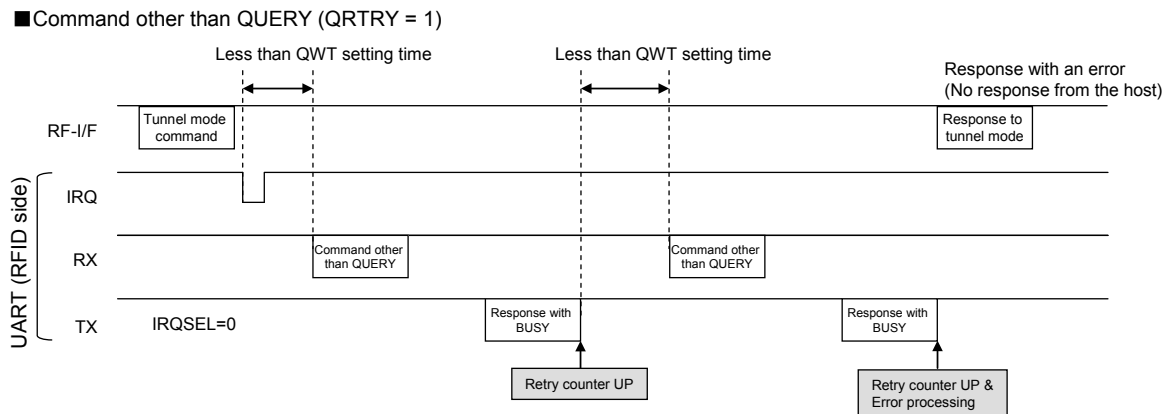

Figure 6-8 Timeout of Waiting for QUERY Command (Command Other Than QUERY)

6.3.4.2 Wait Time for ANSWER Command

The time sequence when the RFID receives no response from the host while it waits an ANSWER command is shown in Figure 6-9. The measurement of timeout starts immediately after the first response (to normal

QUERY command) is sent.

■ No response from the host

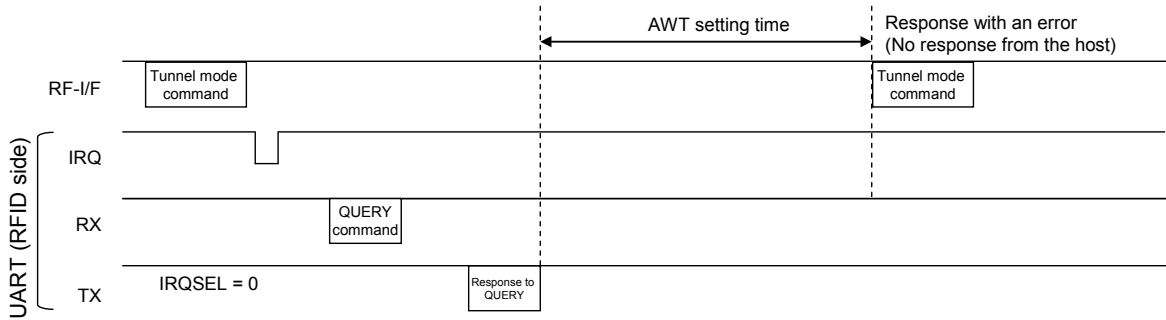

Figure 6-9 Timeout of Waiting for ANSWER Command (No Response from the Host)

Next, the time sequence when the RFID receives a command other than ANSWER from the host while it waits an ANSWER command is shown in Figure 6-10. Note that the timeout measurement time does not include the time from serial communication command issue to the response to the command.

■ Command other than ANSWER

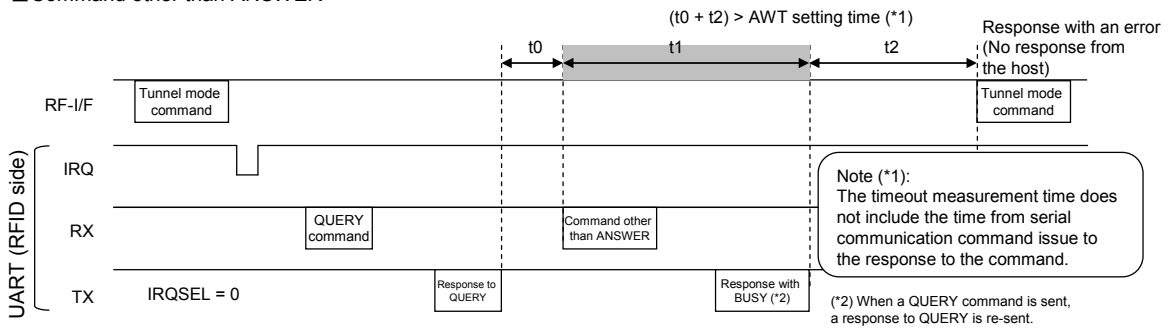

Figure 6-10 Timeout of Waiting for ANSWER Command (Command Other than ANSWER)

6.4 Command

The tunnel mode commands supported by this RFID fall into two types:

RF-interface-side commands between reader/writer and RFID and serial-interface-side commands between the host and RFID.

These commands are shown in Table 6-4 and Table 6-5.

Subsequent sections describe each command in detail.

Table 6-4 RF Interface Command List in Tunnel Mode

| Name | Code | | Description |
|-------|------------|--------------------|--|
| | JISX6319-4 | ISO/IEC 14443TypeB | |
| READ | 0x06 | 0xB0 | Reads data of the host from reader/writer. (Command code is the same as that for RF communication mode) |
| WRITE | 0x08 | 0xD6 | Writes data to the host from reader/writer. (Command code is the same as that for RF communication mode) |

Table 6-5 Serial-Communication-Side Commands List in Tunnel Mode

| Name | Code | Description |
|---------------------|------|---|
| QUERY | 0x28 | The host inquires about the content of tunnel mode command to RFID. |
| ANSWER (normal end) | 0xF8 | The host reports the processing result (normal end) of tunnel mode command to RFID. |
| ANSWER (error) | 0xE8 | The host reports the processing result (error) of tunnel mode command to RFID. |

6.4.1 Read in Tunnel Mode

■ Purpose

Reads data of the host from reader/writer via RFID.

1. Read Command in Tunnel Mode (Reader/Writer to RFID)

■ JIX6319-4

● Format

| Command code | PICC identifier | No. of service file identifiers (k) | List of service file identifiers | No. of blocks (m) | Block list |
|--------------|-----------------|-------------------------------------|----------------------------------|-------------------|------------------|
| 1 byte | 8 bytes | 1 byte | 2×k byte | 1 byte | 2×m or 3×m bytes |

● Data field

| Field | Setting | Remarks |
|-------------------------------------|--|--|
| Command code | 0x06 | |
| PICC identifier | PICC identifier acquired by REQ command described in Section 4.2.6.1 REQ. | |
| No. of service file identifiers (k) | Number of service files Setting range: 0x01(1) to 0x0F(15) | When the range other than the range on the left column is set, the RFID responds with an error. |
| List of service file identifiers | Don't care (Setting example: 0x0900) | When specifying multiple services, the RFID responds with an error if all service files are not set to the same value. |
| No. of blocks (m) | Number of blocks specified in block list Setting range: · RF communication mode: 0x01(1) to 0x0D(13) · Other communication: 0x01(1) to 0x0F(15) | When the range other than the range on the left column is set, the RFID responds with an error. |
| Block list | Block list of data to be read For information about how to set, see the following: · See 4.2.5.6 Block. · See 4.2.5.7 Block List. | |

■ ISO/IEC14443 TypeB

● Format

| CLA | INS | P1 | P2 | Le |
|--------|--------|--------|--------|--------|
| 1 byte | 1 byte | 1 byte | 1 byte | 1 byte |

● Data field

| Field | Setting | Remarks |
|-------|---------|--------------------------------------|
| CLA | 0x00 | Responds with an error, except 0x00. |
| INS | 0xB0 | |

| | | |
|----|---|--|
| P1 | Start address of data to be read · See 4.3.8.5 Address. | |
| P2 | Start address of data to be read · See 4.3.8.5 Address. | |
| Le | Byte length of data to be read · Setting range: 0x01(1) to 0xFB(251) | |

2. QUERY Command (Host to RFID)

- Format

| |
|--------------|
| Command code |
| 1 byte |

- Data field

| Field | Setting | Remarks |
|--------------|---------|---------|
| Command code | 0x28 | |

3. QUERY Response (RFID to Host)

- Format

| | | |
|---------------|---------------|---------------|
| Response code | Start address | Data length n |
| 1 byte | 2 bytes | 1 byte |

- Data field

| Field | Setting | Remarks |
|---------------|---------------------------------|-------------------------------------|
| Response code | 0x08 | |
| Start address | Address at which to start reads | · Byte units · Big endian format |
| Data length n | Size of data to be read | Byte units |

4. ANSWER Command (Host to RFID)

- Format

| | |
|--------------|---------|
| Command code | Data |
| 1 byte | n bytes |

- Data field

| Field | Output value | Remarks |
|--------------|--|-----------------|
| Command code | 0xF8: Normal end 0xE8: Error | |
| Data | Data of the range specified by the response to the QUERY command | See Note below. |

Note: If the status of the ANSWER command is "error", omit the data.

5. ANSWER Response (RFID to Host)

- Format

| |
|--------|
| Status |
| 1 byte |

- Data field

| Field | Output value | Remarks |
|--------|-------------------|---------|
| Status | See 5.2.5 Status. | |

6. Read Response in Tunnel Mode (RFID to R/W)

- JIX6319-4

- Format

| Response code | PICC identifier | Status flag 1 | Status flag 2 | No. of blocks (m) | Block data |
|---------------|-----------------|---------------|---------------|-------------------|------------|
| 1 byte | 8 bytes | 1 byte | 1 byte | 1 byte | 16×m bytes |

- Data field

| Field | Output value | Remarks |
|-------------------|---|---|
| Response code | 0x07 | |
| PICC identifier | See 4.2.5.2 PICC (Proximity IC Card) Identifier. | |
| Status flag 1 | See 4.2.5.8 Status Flag. | |
| Status flag 2 | See 4.2.5.8 Status Flag. | |
| No. of blocks (m) | Number of blocks specified by the tunnel mode read command | Omitted when the status is not "Normal end" |
| Block data | Data specified by the ANSWER command · See 4.2.5.7 Block List. | Omitted when the status is not "Normal end" |

- ISO/IEC14443 TypeB

- Format

| Data | SW1 | SW2 |
|----------------|--------|--------|
| 1 to 251 bytes | 1 byte | 1 byte |

- Data field

| Field | Output value | Remarks |
|-------|--------------------------------|--|
| Data | Read data See 4.3.8.6 Data. | Omitted when the status word is not "Normal end" |
| SW1 | See 4.3.8.7 Status Word. | |
| SW2 | See 4.3.8.7 Status Word. | |

6.4.2 Write in Tunnel Mode

■ Purpose

Writes a data to the host from reader/writer, via RFID.

1. Write Command in Tunnel Mode (R/W to RFID)

■ JIX6319-4

● Format

| Command code | PICC identifier | No. of service file identifiers (k) | List of service file identifier | No. of blocks (m) | Block list | Block data |
|--------------|-----------------|-------------------------------------|---------------------------------|-------------------|------------------|------------|
| 1 byte | 8 bytes | 1 byte | 2×k bytes | 1 byte | 2×m or 3×m bytes | 16×m bytes |

● Data field

| Field | Setting | Remarks |
|-------------------------------------|---|--|
| Command code | 0x08 | |
| PICC identifier | PICC identifier acquired by REQ command described in Section 4.2.6.1 REQ. | |
| No. of service file identifiers (k) | Number of service files Setting range: 0x01(1) to 0x0B(11) | When the range other than the range on the left column is set, the RFID responds with an error. |
| List of service file identifier | Don't care (Setting example: 0x0900) | When specifying multiple services, the RFID responds with an error if all service files are not set to the same value. |
| No. of blocks (m) | Number of blocks specified by block list Setting range: · 1 to 8 service files: 0x01(1) to 0x0C(12) · 9 to 11 service files: 0x01(1) to 0x0B(11) | When the range other than the range on the left column is set, the RFID responds with an error. |
| Block list | Block list of data to be written For information about how to set, see the following: · See 4.2.5.6 Block. · See 4.2.5.7 Block List. | |
| Block data | See 4.2.5.7 Block List. | |

■ ISO/IEC14443 TypeB

■ Format

| CLA | INS | P1 | P2 | Lc | Data |
|--------|--------|--------|--------|--------|----------------|
| 1 byte | 1 byte | 1 byte | 1 byte | 1 byte | 1 to 248 bytes |

■ Data field

| Field | Setting | Remarks |
|-------|---------|-------------------------------------|
| CLA | 0x00 | Responds with an error, except 0x00 |

| | | |
|------|--|--|
| INS | 0xD6 | |
| P1 | Start address of data to be written · See 4.3.8.5 Address. | |
| P2 | Start address of data to be written · See 4.3.8.5 Address. | |
| Lc | Byte length of Data block · Setting range: 0x01(1) to 0xF8(248) | |
| Data | Write data · See 4.3.8.6 Data. | |

2. QUERY Command (Host to RFID)

- Format

| |
|--------------|
| Command code |
| 1 byte |

- Data field

| Field | Setting | Remarks |
|--------------|---------|---------|
| Command code | 0x28 | |

3. QUERY Response (RFID to Host)

- Format

| | | | |
|---------------|---------------|---------------|---------|
| Response code | Start address | Data length n | Data |
| 1 byte | 2 bytes | 1 byte | n bytes |

- Data field

| Field | Setting | Remarks |
|---------------|--------------------------------|-------------------------------------|
| Response code | 0x18 | |
| Start address | Address at which writes start | · Byte units · Big endian format |
| Data length n | Size of data to be written | Byte units |
| Data | Data to be written to the host | |

4. ANSWER Command (Host to RFID)

- Format

| |
|--------------|
| Command code |
| 1 byte |

- Data field

| Field | Output value | Remarks |
|--------------|---------------------------------|---------|
| Command code | 0xF8: Normal end 0xE8: Error | |

5. ANSWER Response (RFID to Host)

- Format

| |
|--------|
| Status |
| 1 byte |

- Data field

| Field | Output value | Remarks |
|--------|-------------------|---------|
| Status | See 5.2.5 Status. | |

6. Write Response in Tunnel Mode (RFID to R/W)

- JIX6319-4

- Format

| Response code | PICC identifier | Status flag 1 | Status flag 2 |
|---------------|-----------------|---------------|---------------|
| 1 byte | 8 bytes | 1 byte | 1 byte |

- Data field

| Field | Output value | Remarks |
|-----------------|--|---------|
| Response code | 0x09 | |
| PICC identifier | See 4.2.5.2 PICC (Proximity IC Card) Identifier. | |
| Status flag 1 | See 4.2.5.8 Status Flag. | |
| Status flag 2 | See 4.2.5.8 Status Flag. | |

- ISO/IEC14443 TypeB

- Format

| SW1 | SW2 |
|--------|--------|
| 1 byte | 1 byte |

- Data field

| Field | Output value | Remarks |
|-------|--------------------------|---------|
| SW1 | See 4.3.8.7 Status Word. | |
| SW2 | See 4.3.8.7 Status Word. | |

7.1 Exclusive Control

While in operation mode, this RFID performs an exclusive control not to receive other commands.

Figure 7-1 shows the exclusive control period. The period is from the start of an operation mode command to the end of the response to the command. In tunnel mode, the period is from the start of the tunnel mode command from reader/writer (see SNo.1 in Figure 6-1 Tunnel Mode Sequence) to the end of the response to the command from RFID to reader/writer (see SNo.8 in Figure 6-1 Tunnel Mode Sequence).

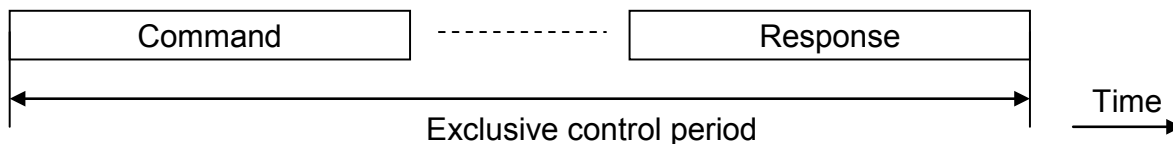

Figure 7-1 Exclusive Control Period

Table 7-1 shows the operations in exclusive control period for each operation mode. Illegular cases that are not generated normally are indicated with parenthesis.

If a command from the host is parity or checksum error, the RFID responds with an error (error code: 0x06), not with BUSY. It responds with BUSY for unimplemented command.

In tunnel mode, the RFID operation differs between before and after IRQ output following the reception of a tunnel mode command from reader/writer.

Table 7-1 Operation during Exclusive Control (Irregular Case in Parenthesis)

| Current operation mode | Receive command | | Operation to a receive command | |
|---------------------------|-----------------------------|--------|--------------------------------|---|
| | Operation mode | From | | |
| RF communication mode | (RF communication mode) | (R/W) | (No response) | |
| | Serial communication mode | Host | Responds with BUSY | Responds with 0x06 for Parity or Checksum error |
| | (Tunnel mode) | (R/W) | (No response) | |
| | Tunnel mode | (Host) | (Responds with BUSY) | Responds with 0x06 for Parity or Checksum error |
| serial communication mode | RF communication mode | R/W | No response | |
| | (Serial communication mode) | (Host) | (No response) | |
| | Tunnel mode | R/W | No response | |
| | (Tunnel mode) | (Host) | (No response) | |
| Tunnel mode | (RF communication mode) | (R/W) | (No response) | |
| | Serial communication mode | Host | Responds with BUSY (See Note.) | Responds with 0x06 for Parity or Checksum error |
| | (Tunnel mode) | (R/W) | (No response) | |
| | Tunnel mode | Host | See 6.1 Tunnel Mode Sequence. | |

(Note) In tunnel mode, this RFID sends no response to the serial communication command for the period between QUERY command reception and response to the command or the period between ANSWER command reception and response to the command. (This operation is the same as the exclusive control operation in serial communication mode.)

Figure 7-2 shows the detail of exclusive control in tunnel mode when UART serial interface is used.

When the RFID receives a command from the host during tunnel mode command reception and before IRQ output, it sends a response with BUSY and then outputs IRQ after the wait time specified by the UARTWT setting elapses.

When the RFID receives a command (other than QUERY) from the host after IRQ output, it responds with BUSY to the command.

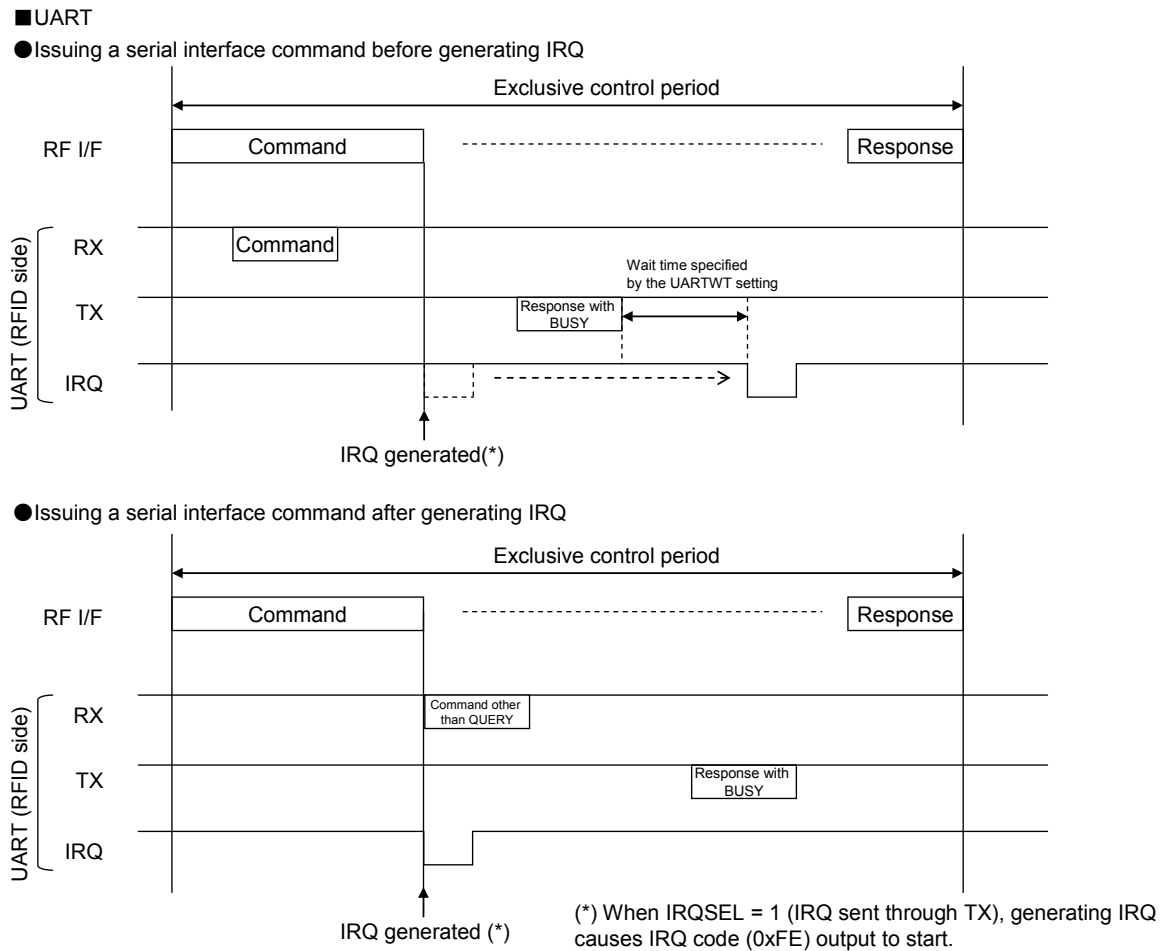

Figure 7-2 Exclusive Control in Tunnel Mode (UART)

Figure 7-3 shows the detail of exclusive control in tunnel mode when clock synchronous serial interface is used.

When the RFID receives a command from the host during tunnel mode command reception and before IRQ output, it sends a response with BUSY and then outputs IRQ again approximately 1 μ s after the response is terminated.

When the RFID receives a command (other than QUERY) from the host after IRQ output that reports a tunnel mode command is received, it responds with BUSY to the command.

■ Clock synchronous

● Issuing a serial interface command before generating IRQ that reports a tunnel mode command is received

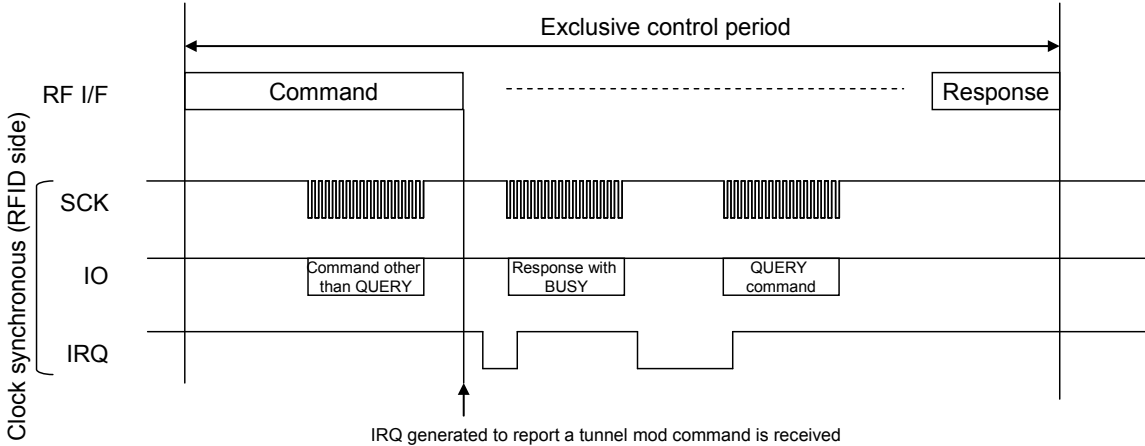

● Issuing a serial interface command after generating IRQ that reports a tunnel mode command is received

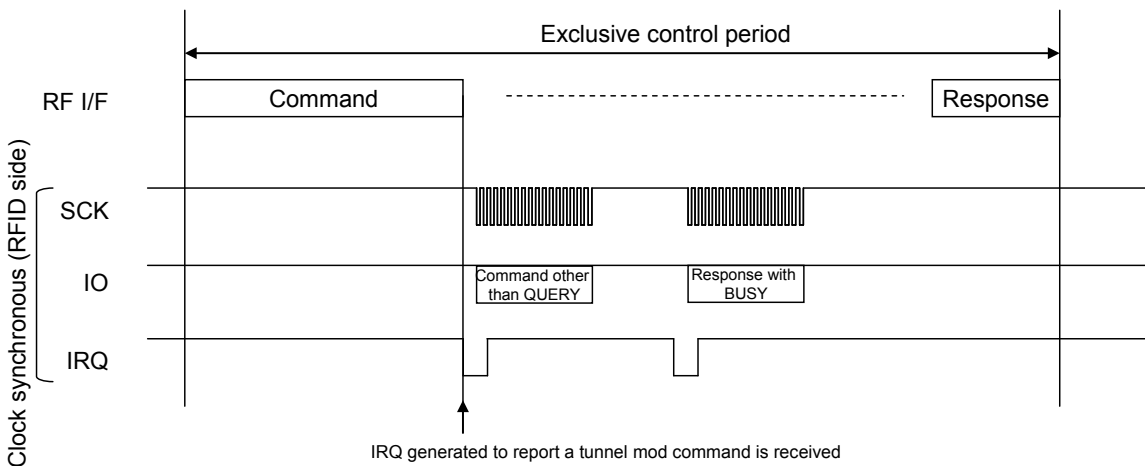

Figure 7-3 Exclusive Control in Tunnel Mode (Clock Synchronous)

7.2 State Transition Diagram in Operation Mode

Figure 7-4 shows the state transition diagram of this RFID in operation mode.

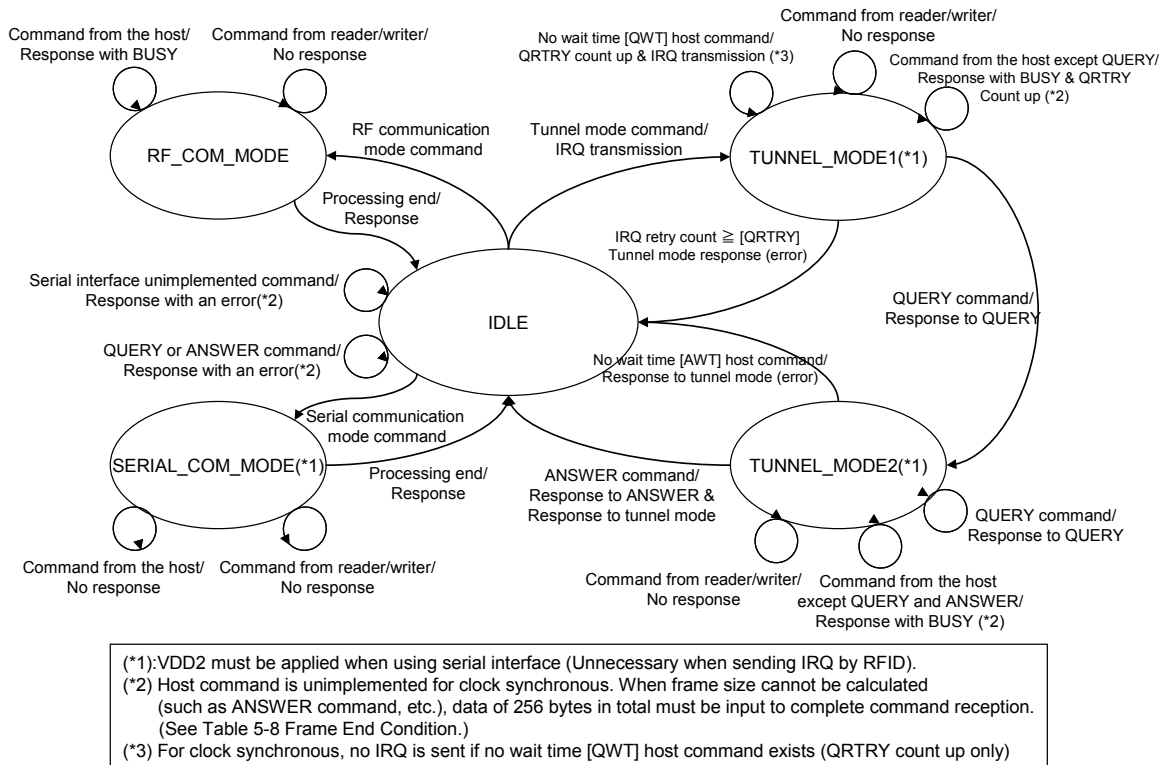
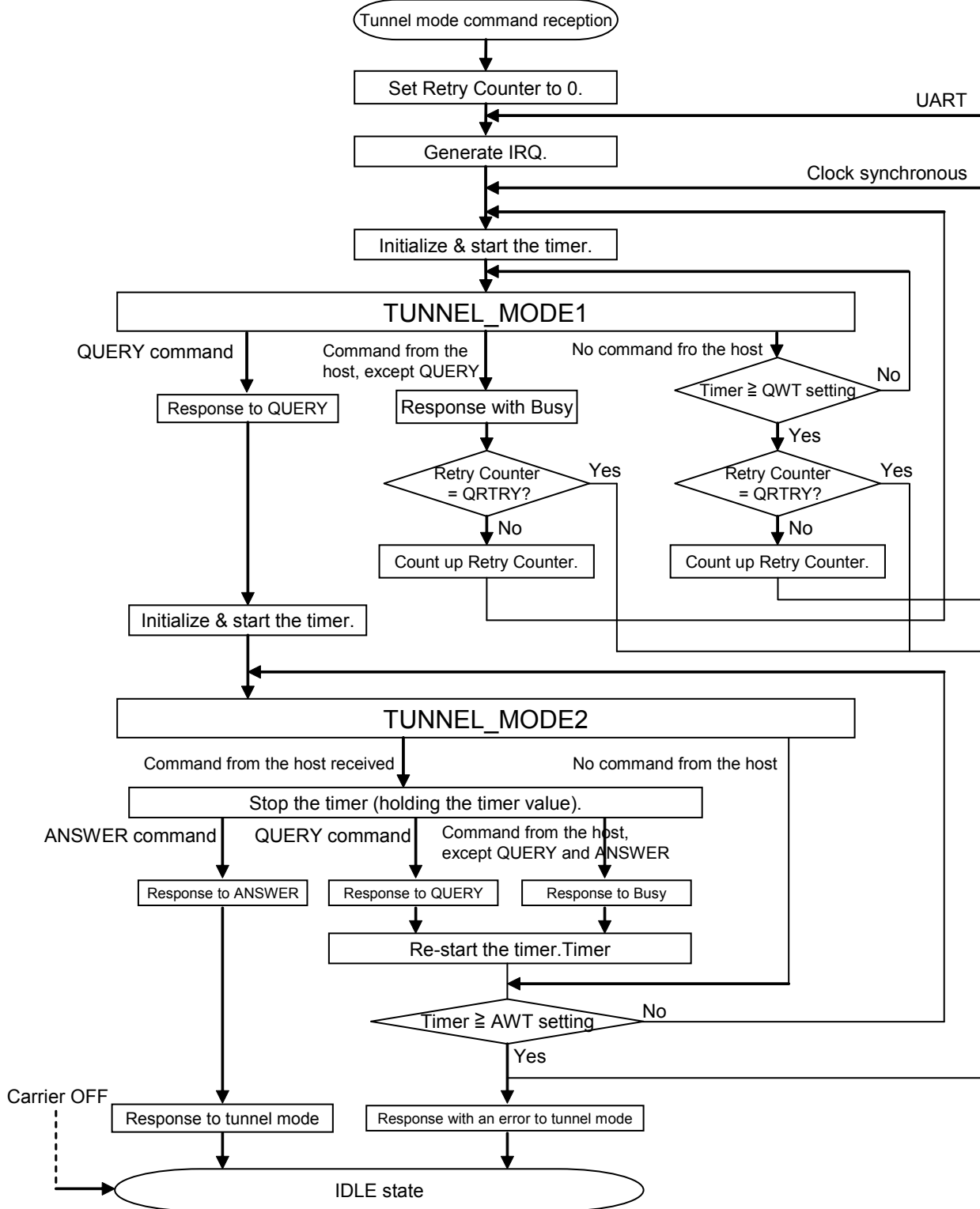

Figure 7-4 State Transition Diagram in Operation Mode

7.3 Flow Chart in Tunnel Mode

Figure 7-5 illustrates a flow chart for tunnel mode. When no command is sent from the host in the TUNNEL_MODE1 state, the RFID re-sends an IRQ for UART but does not re-send for clock synchronous.



Regardless of the state after tunnel mode reception, a Carrier OFF causes the RFID to transition to IDLE state.

Figure 7-5 Flow Chart in Tunnel Mode

Figure 7-6 illustrates the sequence of receiving commands other than QUERY in TUNNEL_MODE1. For unimplemented commands, a wait time of the frame end condition is further added. This specification is applied to UART only.

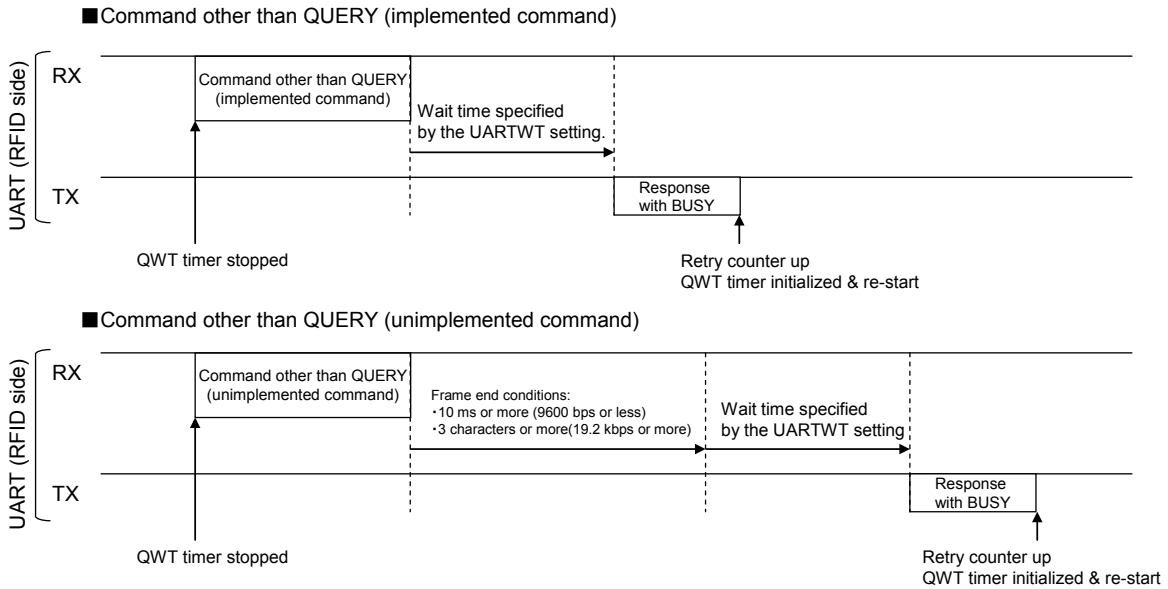

Figure 7-6 Sequence during Command Reception except TUNNEL_MODE1 QUERY (UART only)

7.4 Maximum Command Processing Time (UART)

When specifying the timing to re-send a command of the serial interface (UART), the maximum command processing time must be set to prevent the command from overlapping previous command's transmit/receive periods.

illustrates the definition of command processing time. Additionally, the formula used to calculate the maximum processing time of each command of the serial interface is shown in . t_{UARTWT} has an error of $\pm 25\%$, so is set to 1.25 times.

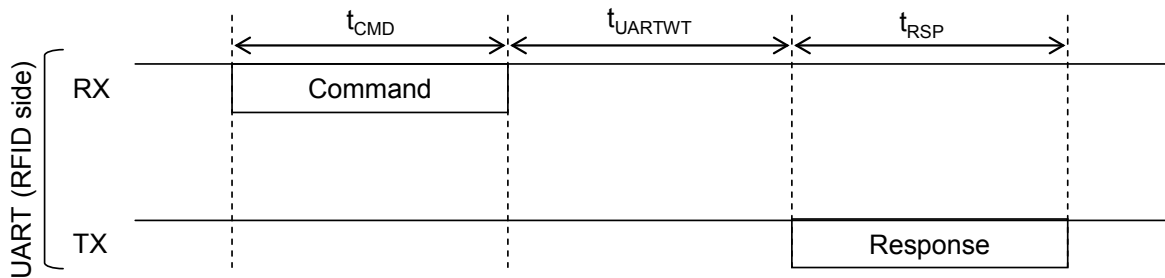

Figure 7-7 Command Processing Time

Table 7-2 Maximum Command Processing Formula (UART)

| | t_{CMD} | t_{UARTWT} | t_{RSP} |
|--------|--|------------------------------|---|
| READ | $\frac{6\text{bytes} \times (11 + \alpha)}{\text{Baudrate}}$ | UARTWT setting $\times 1.25$ | $\frac{257\text{bytes} \times 11}{\text{Baudrate}}$ |
| WRITE | $\frac{257\text{bytes} \times (11 + \alpha)}{\text{Baudrate}}$ | UARTWT setting $\times 1.25$ | $\frac{3\text{bytes} \times 11}{\text{Baudrate}}$ |
| QUERY | $\frac{3\text{bytes} \times (11 + \alpha)}{\text{Baudrate}}$ | UARTWT setting $\times 1.25$ | $\frac{257\text{bytes} \times 11}{\text{Baudrate}}$ |
| ANSWER | $\frac{257\text{bytes} \times (11 + \alpha)}{\text{Baudrate}}$ | UARTWT setting $\times 1.25$ | $\frac{3\text{bytes} \times 11}{\text{Baudrate}}$ |

α refers to the period between characters (from stop bit to start bit of next character)

Chapter 8 Electrical characteristics



Attention

The technical information described in this document is intended only to show the main characteristics and application circuit examples of the product. No license is granted in and to any intellectual property right or other right owned by Panasonic Corporation or any other company. Therefore, no responsibility is assumed by our company as to the infringement upon any such right owned by any other company which may arise as a result of the use of technical information described in this document.

Use caution regarding the orientation of the LSI during use. Mounting of the LSI in an incorrect orientation may cause smoke or fire.

| | |
|-------------|---|
| Type | CMOS integrated circuit with built-in FeRAM |
| Application | Various systems |
| Function | Dual interface RFID |

A. Absolute Maximum Ratings Note 1)

$V_{SS} = 0\text{ V}$

| Parameter | | Symbol | Rating | Unit |
|-----------|---|-----------|--------------|--------------------|
| A1 | Supply voltage Note 2) | V_{DD2} | -0.3 to +4.6 | V |
| A2 | | V_{DD1} | -0.3 to +4.6 | V |
| A3 | | V_{DD} | -0.3 to +2.5 | V |
| A4 | Voltage antenna terminals swing (VB Peak to peak) Note3) | V_{CBA} | ± 30 | V |
| A5 | Input pin voltage (TEST, NCLP) | V_{I2} | -0.3 to +4.6 | V |
| A6 | Input pin voltage (SEL, RX) | V_{I3} | -0.3 to +6.0 | V |
| A7 | Input/output pin voltage (TX3V) | V_{IO1} | -0.3 to +4.6 | V |
| A8 | Input/output pin voltage (TX5V) | V_{IO2} | -0.3 to +6.0 | V |
| A9 | Output pin voltage (IRQ3V) | V_{O1} | -0.3 to +4.6 | V |
| A10 | Output pin voltage (IRQ5V) | V_{O2} | -0.3 to +6.0 | V |
| A11 | Output current | I_O | +12 | mA |
| A12 | Storage temperature Note 3) | T_{stg} | -40 to 85 | $^{\circ}\text{C}$ |
| A13 | Operating ambient temperature | T_{opr} | -20 to 85 | $^{\circ}\text{C}$ |

Note 1) The absolute maximum ratings are the limit values beyond which the IC may be damaged.

Operation is not guaranteed under these conditions.

Note 2) V_{DD1} and V_{DD} are not external-power supply input pins.

Note 3) Voltage antenna terminals swing (V_{CBA}) is shown as follows.

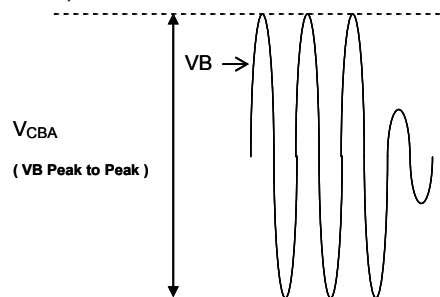

Usage Notes

1. Decoupling capacitor should be connected between VDD2 and VSS, at as a short distance as possible.
2. Decoupling capacitor should be connected between VDD1 and VSS, and Between VDD and VSS, respectively at as a short distance as possible.

Between VDD and VSS : 0.1 μ F

Between VDD1 and VSS : 0.1 μ F

Between VDD1 and VSS : 0.1 μ F

B. Operating Conditions

$T_a = -20^{\circ}\text{C}$ to 85°C , $V_{SS} = 0\text{ V}$

| Parameter | Symbol | Conditions | Limits | | | Unit |
|-----------|--|------------|---------------------------|-----|-----|------|
| | | | Min | Typ | Max | |
| B1 | Supply voltage VDD2 | V_{DD2} | See Conditions 1) and 2). | | | V |
| B2 | Pullup voltage for 5V tolerant I/O (TX5V, IRQ5V) | V_{PU5} | 4.5 | - | 5.5 | V |

Reference Value

$T_a = -20^{\circ}\text{C}$ to 85°C , $V_{SS} = 0\text{ V}$

| Parameter | Symbol | Conditions | Limits | | | Unit |
|-----------|---------------------|------------|---|-----|-----|------|
| | | | Min | Typ | Max | |
| B3 | Output voltage VDD1 | V_{DD1} | See Conditions 1) and 2), or D9 (RF = High) on page 10. | | | V |
| B4 | Output voltage VDD | V_{DD} | See Conditions 1) and 2), or D9 (RF = High) on page 10. | | | V |

Condition 1)

■ $V_{EXT} = 4.5\text{ V}$ to 5.5 V

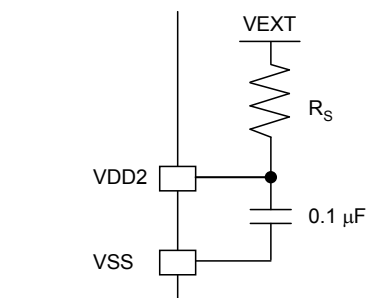

Fig. 1

- When the external supply voltage $V_{EXT} = 4.5\text{ V}$ to 5.5 V , connect a $5.1\text{-k}\Omega$ resistor R_S between VEXT and VDD2 as shown in Fig. 1.
- The tolerance of resistor R_S must be within $\pm 5\%$.
- Set NCLP to low to turn on the internal clamp circuit.

Condition 2)

■ $V_{EXT} = 1.8\text{ V}$ to 3.6 V

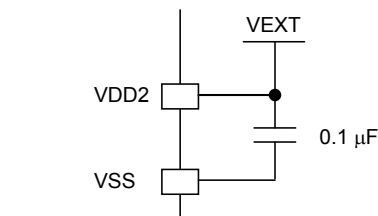

Fig. 2

- When the external supply voltage $V_{EXT} = 1.8\text{ V}$ to 3.6 V , connect VDD2 to VEXT directly as shown in Fig. 2.
- Set NCLP to high to turn off the internal clamp circuit.

C. Electrical Characteristics

D.C. Characteristics

Ta = -20°C to 85°C, V_{SS} = 0 V

| Parameter | Symbol | Conditions | Limits | | | Unit | |
|-----------|----------------------------------|-------------------|--|-----|-----|------|----|
| | | | Min | Typ | Max | | |
| C1 | Operating supply current of VDD2 | I _{DD2A} | See condition 1) (V _{EXT} = 5.5 V) on page 4. | - | 430 | 500 | μA |
| C2 | Operating supply current of VDD2 | I _{DD2B} | See condition 2) (V _{EXT} = 3.6 V) on page 4. | - | 310 | 500 | μA |

Reference Value

Ta = -20°C to 85°C, V_{SS} = 0 V

| Parameter | Symbol | Conditions | Limits | | | Unit | |
|-----------|----------------------------------|------------------|---|-----|-----|------|----|
| | | | Min | Typ | Max | | |
| C3 | Operating supply current of VDD1 | I _{DD1} | V _{DD1} = 2.0 V, with 13.56-MHz clock input between VA and VB pins for RF communication. | - | 220 | 400 | μA |

Note 5) The value specified in C3 is for reference only and is inspected in the IC manufacturing process based on the RF communication standards.

I/O Pin Characteristics
 $T_a = -20^{\circ}\text{C to } 85^{\circ}\text{C}, V_{SS} = 0\text{ V}$

| Parameter | Symbol | Conditions | Limits | | | Unit |
|-----------|--------|------------|--------|-----|-----|------|
| | | | Min | Typ | Max | |

Input Pin: TEST

| | | | | | | | |
|----|-----------------------|-----------|--------------|-----|------|----------------------|---------------|
| C4 | Input voltage (Low) | V_{IL1} | | 0 | - | $0.3 \times V_{DD2}$ | V |
| C5 | Input leakage current | I_{LK1} | Fixed to low | -10 | 0.02 | +10 | μA |

Input Pin: NCLP

| | | | | | | | |
|----|-----------------------|-----------|--|----------------------|------|----------------------|---------------|
| C6 | Input voltage (High) | V_{IH2} | | $0.7 \times V_{DD2}$ | - | V_{DD2} | V |
| C7 | Input voltage (Low) | V_{IL2} | | 0 | - | $0.3 \times V_{DD2}$ | V |
| C8 | Input leakage current | I_{LK2} | | -10 | 0.02 | +10 | μA |

Input Pin: RX, SEL (5 V Tolerant)

| | | | | | | | |
|-----|-----------------------|-----------|--|----------------------|------|----------------------|---------------|
| C9 | Input voltage (High) | V_{IH3} | | $0.6 \times V_{DD2}$ | - | 5.5 | V |
| C10 | Input voltage (Low) | V_{IL3} | | 0 | - | $0.2 \times V_{DD2}$ | V |
| C11 | Input leakage current | I_{LK3} | | -20 | 0.04 | +20 | μA |

Input/Output Pin: TX3V

| | | | | | | | |
|-----|------------------------|-----------|--|----------------------|------|----------------------|---------------|
| C12 | Input voltage (High) | V_{IH4} | | $0.7 \times V_{DD2}$ | - | V_{DD2} | V |
| C13 | Input voltage (Low) | V_{IL4} | | 0 | - | $0.3 \times V_{DD2}$ | V |
| C14 | Output leakage current | I_{LK4} | | -10 | 0.02 | +10 | μA |
| C15 | Output voltage (Low) | V_{OL4} | $V_{DD2} = 3.3\text{ V}, I_{OL} = 4.0\text{ mA}$ | - | - | 0.4 | V |

Input/Output Pin: TX5V (5 V Tolerant)

| | | | | | | | |
|-----|------------------------|-----------|--|----------------------|------|----------------------|---------------|
| C16 | Input voltage (High) | V_{IH5} | | $0.6 \times V_{DD2}$ | - | 5.5 | V |
| C17 | Input voltage (Low) | V_{IL5} | | 0 | - | $0.2 \times V_{DD2}$ | V |
| C18 | Output leakage current | I_{LK5} | | -20 | 0.04 | +20 | μA |
| C19 | Output voltage (Low) | V_{OL5} | $V_{DD2} = 3.3\text{ V}, I_{OL} = 4.0\text{ mA}$ | - | - | 0.4 | V |

Output Pin: IRQ3V

| | | | | | | | |
|-----|------------------------|-----------|--|-----|------|-----|---------------|
| C20 | Output leakage current | I_{LK6} | | -10 | 0.02 | +10 | μA |
| C21 | Output voltage (Low) | V_{OL6} | $V_{DD2} = 3.3\text{ V}, I_{OL} = 4.0\text{ mA}$ | - | - | 0.4 | V |

Output Pin: IRQ5V (5 V Tolerant)

| | | | | | | | |
|-----|------------------------|-----------|--|-----|------|-----|---------------|
| C22 | Output leakage current | I_{LK7} | | -20 | 0.04 | +20 | μA |
| C23 | Output voltage (Low) | V_{OL7} | $V_{DD2} = 3.3\text{ V}, I_{OL} = 4.0\text{ mA}$ | - | - | 0.4 | V |

Reference Information

In our evaluation, 3.3-k Ω (reference value) pullup resistors are connected to the open-drain pins TX3V, TX5V, IRQ3V and IRQ5V. Determine the value of pullup resistors based on data rate, load capacitance, and other factors.

Input Capacitance

$V_{SS} = 0\text{ V}$

| Parameter | | Symbol | Conditions | Limits | | | Unit |
|-----------|--|--------|--|--------|------|------|------|
| | | | | Min | Typ | Max | |
| C24 | Input capacitance between antenna coil connection pins (VA and VB) | C_i | $T_a = 25^\circ\text{C}$ 13.56 MHz, amplitude (RMS) 1 V, bias 2 V | 15.5 | 17.5 | 19.5 | pF |

Load Switch

$T_a = -20^\circ\text{C}$ to 85°C , $V_{SS} = 0\text{ V}$

| Parameter | | Symbol | Conditions | Limits | | | Unit |
|-----------|------------------------|----------|------------------------|--------|-----|-----|----------|
| | | | | Min | Typ | Max | |
| C25 | Load switch resistance | R_{LD} | Between VA and VB pins | 90 | 150 | 210 | Ω |

Clamp Circuit

$T_a = -20^\circ\text{C}$ to 85°C , $V_{SS} = 0\text{ V}$

| Parameter | | Symbol | Conditions | Limits | | | Unit |
|-----------|------------------------|-----------|-----------------------------|--------|-----|-----|------|
| | | | | Min | Typ | Max | |
| C26 | Clamp voltage for VDD2 | V_{CLP} | See condition 1) on page 4. | - | - | 3.6 | V |

D. AC Characteristics

Serial Interface (UART)

Ta = -20°C to 85°C, V_{SS} = 0 V

| Parameter | Symbol | Conditions | Limits | | | Unit |
|-------------------------|------------------|------------|--------------------------|-----|--------------------------|------|
| | | | Min | Typ | Max | |
| D1 RX rise time | t _{RRX} | | - | - | t _{DRX} × 0.025 | s |
| D2 RX fall time | t _{FRX} | | - | - | t _{DRX} × 0.025 | s |
| D3 TX 1-bit data period | t _{DTX} | | t _{DTX} × 0.975 | - | t _{DRX} × 1.025 | s |

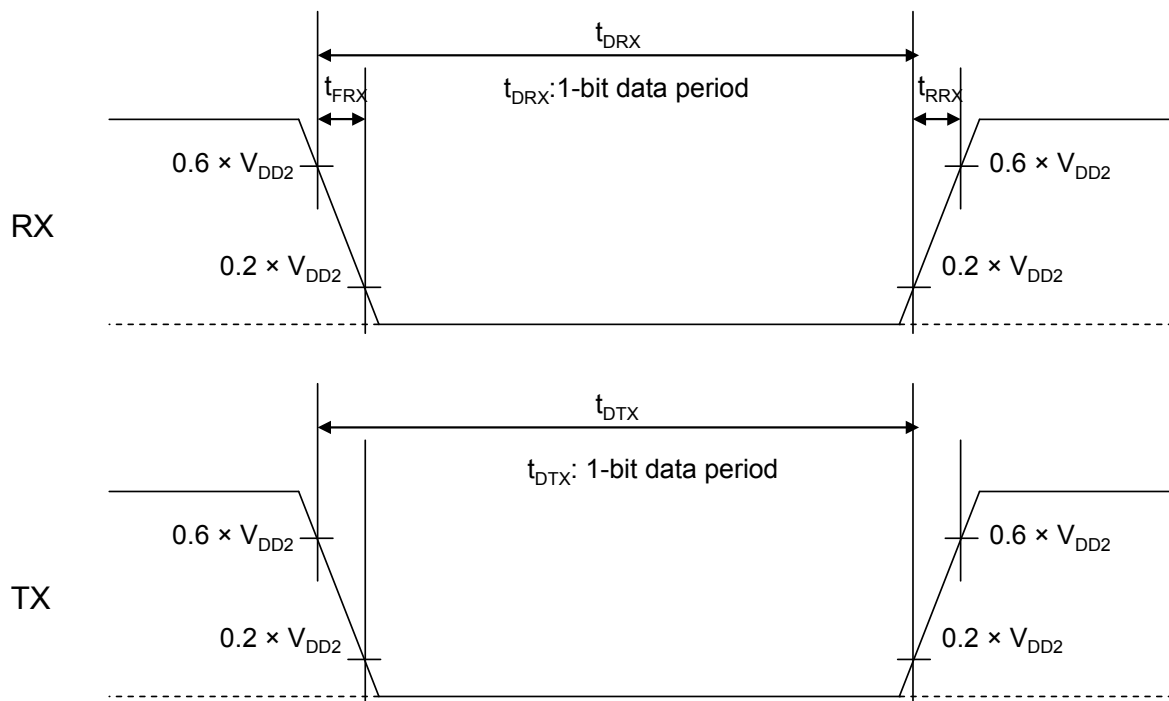

Fig. 3

Serial Interface (Clock Synchronous)

Ta = -20°C to 85°C, V_{SS} = 0 V

| Parameter | | Symbol | Conditions | Limits | | | Unit |
|-----------|--------------------------|-------------------|------------|--------|-----|-----|------|
| | | | | Min | Typ | Max | |
| D4 | Clock frequency | f _{SCK} | | 0.01 | - | 1 | MHz |
| D5 | Receive data setup time | t _{RXDS} | | 100 | - | - | ns |
| D6 | Receive data hold time | t _{RXDH} | | 100 | - | - | ns |
| D7 | Transmit data setup time | t _{TXDS} | | 100 | - | - | ns |
| D8 | Transmit data hold time | t _{TXDH} | | 100 | - | - | ns |

■ Data Reception

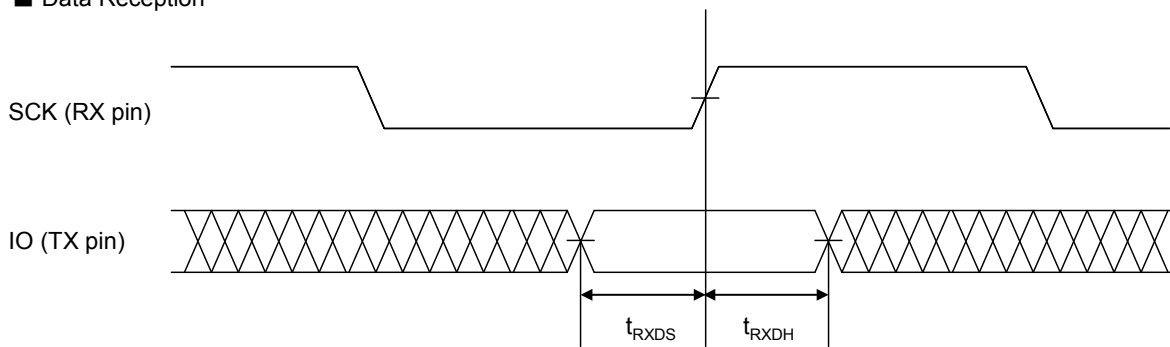

■ Data Transmission

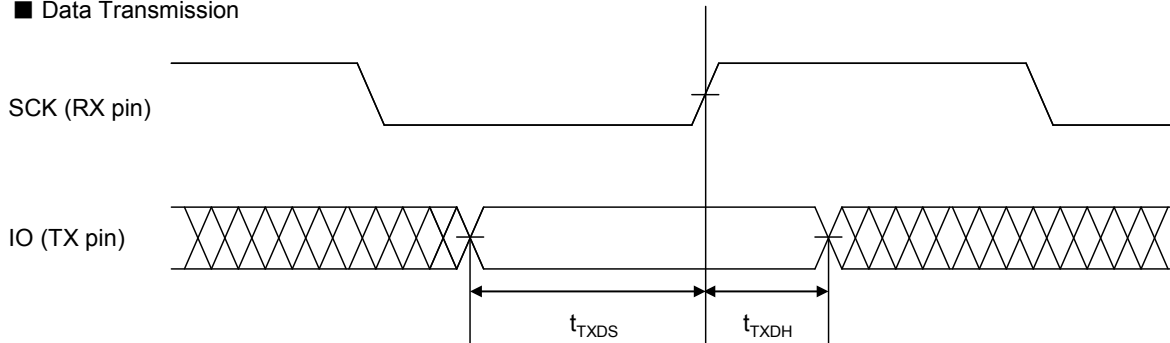

Fig. 4

RF Interface

Ta = -20°C to 85°C, V_{SS} = 0 V

| Parameter | | Symbol | Conditions | Limits | | | Unit |
|-----------|---|-------------------|--|--------|-----|-----|------|
| | | | | Min | Typ | Max | |
| D9 | VB pin voltage (Peak to peak, RF = High, VDD2: Not applied) | V _{RFH1} | The frequency of the antenna coil connection pins: 13.56 MHz | 4.5 | - | 21 | V |
| D10 | VB pin voltage (Peak to peak, RF = High, VDD2: Applied) | V _{RFH2} | The frequency of the antenna coil connection pins: 13.56 MHz | 3.5 | - | 21 | V |
| D11 | Modulation factor for command reception | m | JISX6319-4 standards: Data rate of 212 kbps Output waveform with independent reader/writer | 4.0 | - | 14 | % |

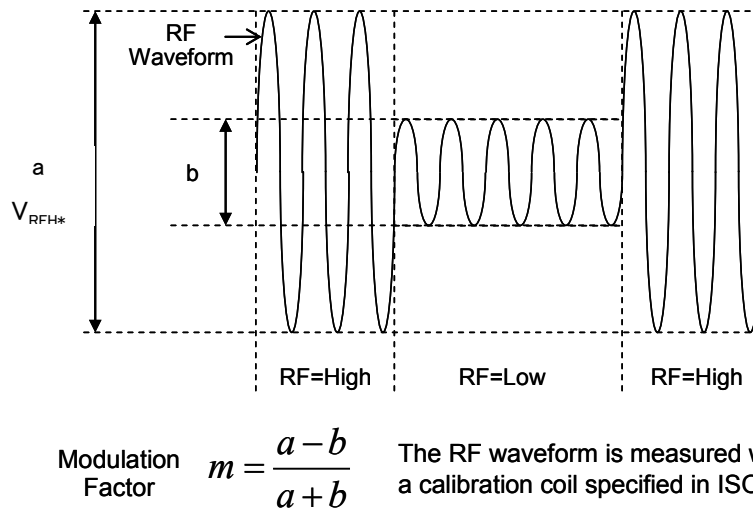

Fig. 5

E. Power Supply Startup

Ta = -20°C to 85°C, V_{SS} = 0 V

| Parameter | Symbol | Conditions | Limits | | | Unit |
|-----------|------------------------------------|--|--------|-----|-----|------|
| | | | Min | Typ | Max | |
| E1 | Startup time for VEXT power supply | t _{BOOT1} VEXT = 4.5 V to 5.5 V See note 6) | - | - | 5 | ms |
| E2 | Startup time for VEXT power supply | t _{BOOT2} VEXT = 1.8 V to 3.6 V See note 7) | - | - | 3 | ms |
| E3 | Pulse width for VEXT power supply | t _{PLW1} VEXT = 4.5 V to 5.5 V See note 6) | 5 | - | - | ms |
| E4 | Pulse width for VEXT power supply | t _{PLW2} VEXT = 1.8 V to 3.6 V See note 7) | 3 | - | - | ms |
| E5 | Rise time for VEXT power supply | t _{SLW1} VEXT = 4.5 V to 5.5 V See note 6) | 0.1 | - | - | ms |
| E6 | Rise time for VEXT power supply | t _{SLW2} VEXT = 1.8 V to 3.6 V See note 7) | 0.1 | - | - | ms |

Note 7) Smooth capacitor between VDD2 and VSS: 0.1 μF, Smooth capacitor between VDD and VSS: 0.1 μF
Resistor between VEXT and VDD2: 5.1 kΩ

Note 8) Smooth capacitor between VDD2 and VSS: 0.1 μF, Smooth capacitor between VDD and VSS: 0.1 μF

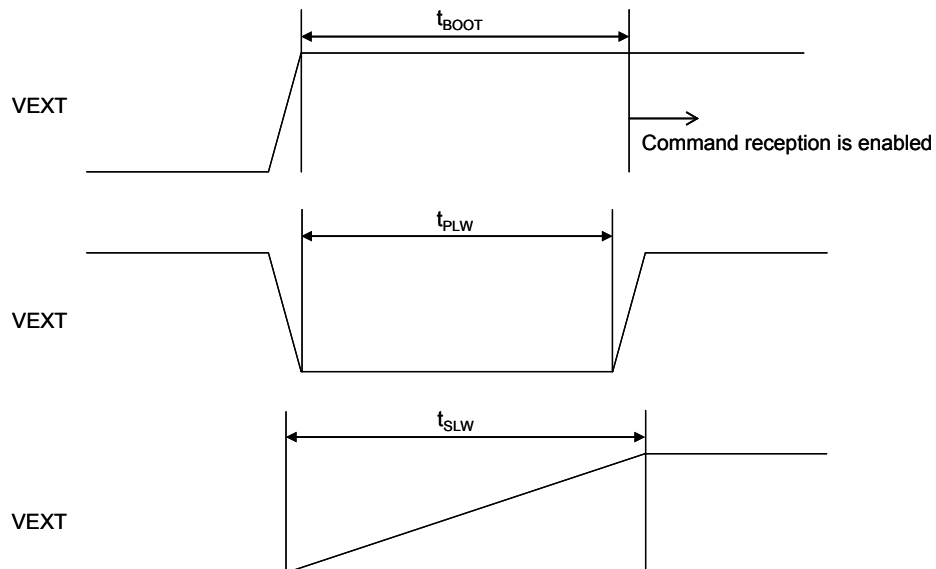

Fig. 6

Revision History

Revised on Jun14, 2013

| Purpose | Version 1.0 | | | Version xx | | |
|---------|-------------|---------|-----------------|------------|---------|----------|
| | Page | Section | Comments | Page | Section | Comments |
| | | | Initial edition | | | |

Revised on Oct 08, 2013

| Purpose | Version 1.0 | | | Version 1.1 | | |
|---------|-------------|-----------|--|-------------|-----------|--|
| | Page | Section | Comments | Page | Section | Comments |
| Modify | P50 | Table4-10 | Physical adr 0x0001 Value : 0x0F Physical adr 0x0003 to 0x0004 Value : 0x0018 | P50 | Table4-10 | Physical adr 0x0001 Value : 0x0D Physical adr 0x0003 to 0x0004 Value : 0x001A |

Revised on Feb 24, 2015

| Purpose | Version 1.1 | | | Version 1.2 | | |
|---------|-------------|---------|----------|-------------|---------|---|
| | Page | Section | Comments | Page | Section | Comments |
| Add | --- | --- | --- | P107 | --- | Chapter 8 Electrical characteristics |

Request for your special attention and precautions in using the technical information and semiconductors described in this book

- (1) If any of the products or technical information described in this book is to be exported or provided to non-residents, the laws and regulations of the exporting country, especially, those with regard to security export control, must be observed.
- (2) The technical information described in this book is intended only to show the main characteristics and application circuit examples of the products. No license is granted in and to any intellectual property right or other right owned by Panasonic Corporation or any other company. Therefore, no responsibility is assumed by our company as to the infringement upon any such right owned by any other company which may arise as a result of the use of technical information de-scribed in this book.
- (3) The products described in this book are intended to be used for general applications (such as office equipment, communications equipment, measuring instruments and household appliances), or for specific applications as expressly stated in this book.
Please consult with our sales staff in advance for information on the following applications, moreover please exchange documents separately on terms of use etc.: Special applications (such as for in-vehicle equipment, airplanes, aerospace, automotive equipment, traffic signaling equipment, combustion equipment, medical equipment and safety devices) in which exceptional quality and reliability are required, or if the failure or malfunction of the products may directly jeopardize life or harm the human body.
Unless exchanging documents on terms of use etc. in advance, it is to be understood that our company shall not be held responsible for any damage incurred as a result of or in connection with your using the products described in this book for any special application.
- (4) The products and product specifications described in this book are subject to change without notice for modification and/or improvement. At the final stage of your design, purchasing, or use of the products, therefore, ask for the most up-to-date Product Standards in advance to make sure that the latest specifications satisfy your requirements.
- (5) When designing your equipment, comply with the range of absolute maximum rating and the guaranteed operating conditions (operating power supply voltage and operating environment etc.). Especially, please be careful not to exceed the range of absolute maximum rating on the transient state, such as power-on, power-off and mode-switching. Otherwise, we will not be liable for any defect which may arise later in your equipment.
Even when the products are used within the guaranteed values, take into the consideration of incidence of break down and failure mode, possible to occur to semiconductor products. Measures on the systems such as redundant design, arresting the spread of fire or preventing glitch are recommended in order to prevent physical injury, fire, social damages, for example, by using the products.
- (6) Comply with the instructions for use in order to prevent breakdown and characteristics change due to external factors (ESD, EOS, thermal stress and mechanical stress) at the time of handling, mounting or at customer's process. We do not guarantee quality for disassembled products or the product re-mounted after removing from the mounting board.
When using products for which damp-proof packing is required, satisfy the conditions, such as shelf life and the elapsed time since first opening the packages.
- (7) When reselling products described in this book to other companies without our permission and receiving any claim of request from the resale destination, please understand that customers will bear the burden.
- (8) This book may be not reprinted or reproduced whether wholly or partially, without the prior written permission of our company.