

Quick Start Guide

KVM Extender USB

Model: ODT60001

Este guía esta disponible en español en la página de Tripp Lite:
www.tripplite.com/support

Ce guide est disponible en français sur le site Web de Tripp Lite :
www.tripplite.com/support

Русскоязычная версия настоящего краткого руководства представлена
на веб-сайте компании Tripp Lite по адресу: www.tripplite.com

PROTECT YOUR INVESTMENT!

Register your product for quicker service
and ultimate peace of mind.

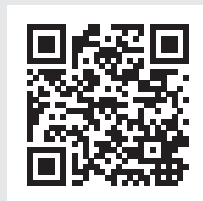

www.tripplite.com/warranty



1111 W. 35th Street, Chicago, IL 60609 USA • www.tripplite.com/support

Copyright © 2017 Tripp Lite. All rights reserved.

1. Important Safety Instructions

- The device must only be opened by a qualified technician.
- Disconnect device from AC mains before service operation!
- Use of this equipment in life support applications where failure of this equipment can reasonably be expected to cause the failure of the life support equipment or to significantly affect its safety or effectiveness is not recommended.

2. Product Features

- Compatible with any KVM switch / computer
- Extends KVM control over a computer up to a distance of 500 ft. (150 m)
- Integrated local port for local keyboard, mouse and monitor
- 2-port KVM switch built into remote unit
- Supports all major OS

3. Package Contents

- Transmitter
- Receiver
- (x2) VGA + USB Cable
- External Power Supply with NEMA 1-15P Plug (Input: 100-240V, 50/60Hz Output: 12V/1000mA) and Plug Adapters for UK, Europe and Australia, NEMA*
- Screwdriver
- (x8) Rubber Feet
- Owner's Manual

* ODT60001-AC-INT available for purchase separately if additional power supply is needed.

4. KVM Extender USB Units

4.1 Transmitter Button / LEDs

Button / LED	Function
Lock button	Press to keep control of the connected computer at the Transmitter position
Control LED	Blinks when Transmitter position has control of the Transmitter position computer
Lock LED	Blinks after either Transmitter or Receiver position presses the Lock button for control

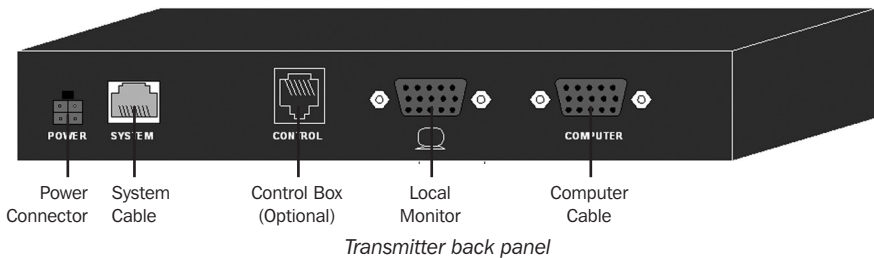
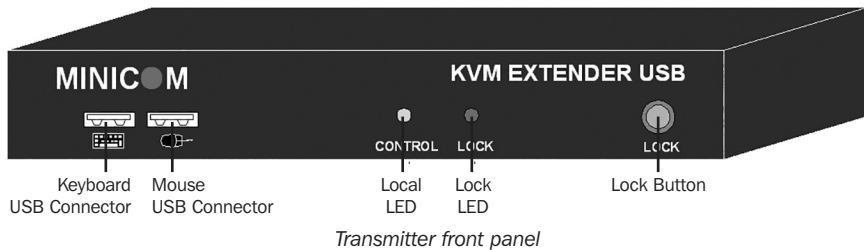

4.2 Receiver Buttons / LEDs

The Receiver can be located up to 500 ft. (150 m) away from the Transmitter.

Button / LED	Function
Lock button	Press to lock control of the Transmitter computer at the Receiver position
Local button	Press to toggle control between the local Receiver computer and the remote Transmitter computer (See section 9.1: Keyboard Hotkeys)
Lock LED	Blinks after either Transmitter or Receiver position presses the Lock button for control
Local LED	Blinks when Receiver position has control of the Receiver position computer

4. KVM Extender USB Units

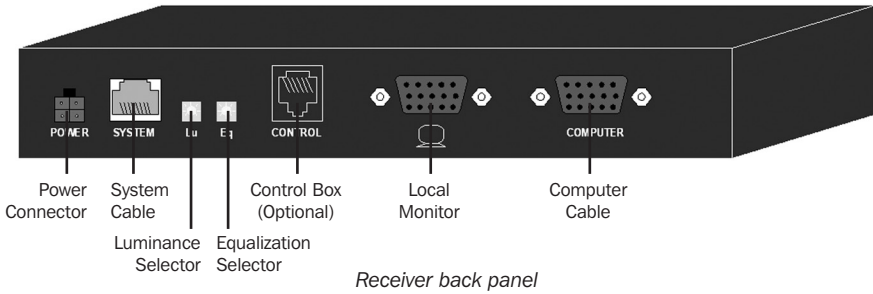
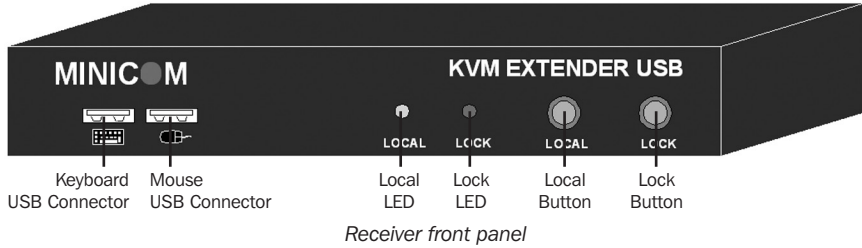

5. Pre-Installation Instructions

Place cables away from fluorescent lights, air conditioners, and equipment that is likely to generate electrical noise.

6. Connecting the System

When using the system as an extender, connect the system as shown in Figure 6-1. The connections are explained below.

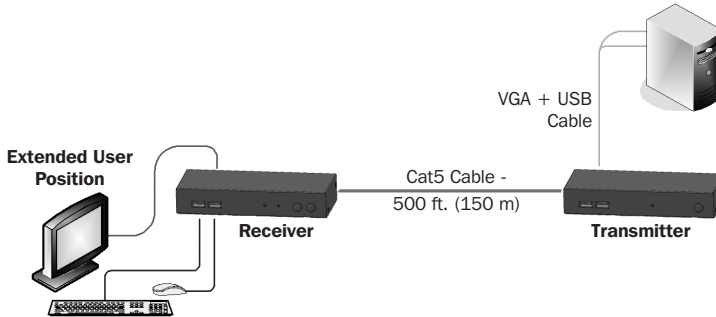

Figure 6-1: KVM Extender USB as an extender

6.1 Connecting the Transmitter

Connect a VGA + USB cable (Figure 6-2) to the Transmitter and a computer. Connect the HD15 connector to the Transmitter Computer port and connect the VGA and USB connectors to the local computer Monitor and USB ports.



Figure 6-2: VGA + USB cable

6.2 Connecting a KVM Workstation to the Receiver

Connect a KVM workstation to the Receiver. Connect a keyboard and mouse to the Receiver Keyboard and Mouse USB ports. Connect a monitor to the Receiver Monitor port.

6.3 Connecting the System Cable

Connect the System cable CAT5/6/7 FTP cable to the System ports of the Transmitter and Receiver.

6.4 Connecting to the Power Supply

The Transmitter receives its power from the connected computer and does not generally need an external power supply. However, when the Transmitter is connected to a KVM switch, it may need an external power supply. If additional power is needed, use a ODT60001-AC-INT (not included, purchase separately).

Connect the Receiver to utility power with the external power supply provided.

7. Extender System with Optional Computer at Receiver Position

You can connect a computer to the Receiver position. The Receiver position can then either control the local computer or the Transmitter position computer (Figure 7-1).

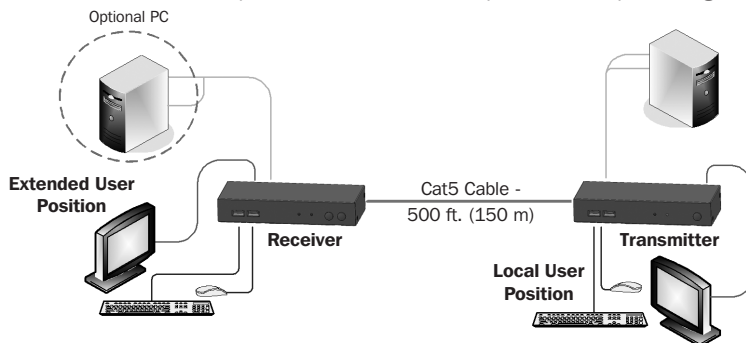

Figure 7-1: Extender system with optional computer at Receiver position

The connections are the same as outlined above, with the addition of a computer connected to the Receiver as follows:

Connect a VGA + USB cable to the Receiver and a computer. Connect the HD15 connector to the Receiver Computer port and connect the VGA and USB connectors to the computer Monitor and USB ports.

8. Extender + KVM Switch System with Optional Computer at Receiver Position

You can connect a KVM switch to the Receiver position. The Receiver position can then either control the local computer or any computer connected to the KVM switch at the Transmitter position computer (Figure 8-1).

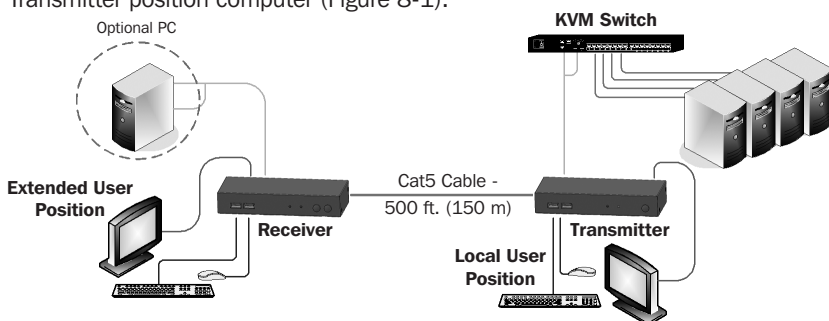

Figure 8-1: Extender + KVM switch with optional computer at Receiver position

The connections are the same as outlined above, with the addition of a KVM switch connected to the Transmitter as follows:

Connect a VGA + USB cable to the Transmitter and the KVM switch. Connect the HD15 connector to the Transmitter Computer port and connect the VGA and USB connectors to the KVM switch Monitor and USB ports.

9. Operating the KVM Extender USB System

The system works on a first-come, first-served basis – press the keyboard or move the mouse at either the Transmitter (where relevant) or Receiver position to take control of the Transmitter position computer.

Transmitter Position: Press the Lock button to keep/gain control of the computer at the Transmitter position. The Lock LED at the Transmitter position illuminates and blinks at the Receiver position. The Control LED at the Transmitter position illuminates.

Receiver Position: Press the Lock button to keep control of the Transmitter computer at the Receiver position. The Lock LED at the Receiver position illuminates and blinks at the Transmitter position.

Press the Local button to gain control of the Receiver computer position. The Local LED blinks.

Note: You can only gain control by pressing the Lock button if the Lock LED is currently not blinking.

Pressing the Lock button again at either position releases control and the Lock LEDs turn off.

9.1 Keyboard Hotkeys

To toggle between the Transmitter and the Receiver position, press: **Caps Lock** twice, release, then press **C**.

To turn the beeper sound on/off, press: **Caps Lock** twice, release, then press **B**.

9.2 Adjusting the Picture

To adjust the picture quality, use the included screwdriver to turn the Luminance and Equalization Picture adjusters located on the Receiver's rear panel.

10. Specifications

System Cable	Cat5/6/7 FTP 2x4x24 AWG solid-wire cable
Maximum Distance	500 ft. (150 m)
Mouse Support	USB mouse
Operating Systems Supported	All major operating systems
Management	Push button or external control unit
Screen Resolution	Up to 1600 x 1200 @ 75 Hz
Operating Temperature	32° to 104°F (0° to 40°C)
Storage Temperature	-40°F to 104°F (-40° to 40°C)
Warranty Period	3-year limited

10. Specifications

	Transmitter	Receiver
Cables & Connectors	HDD15F (VGA + USB cable) – for computer or KVM switch	HDD15F (VGA + USB cable) – for optional local computer
	USB X 2: for Keyboard + Mouse	USB X 2: for Keyboard + Mouse
	HDD15 : for monitor	HDD15 : for monitor
	RJ45 – System	RJ45 – System
	RJ11 – External control unit	RJ11 – External control unit
Dimensions	3.3 x 4.4 x 0.98 in. (84 x 112 x 25 mm)	3.3 x 4.4 x 0.98 in. (84 x 112 x 25 mm)
Shipping Weight	3.9 lb. (1.75 kg)	
Power Supply	From computer or external power supply (model ODT60001-AC-INT, sold separately)	Included external power supply (12VDC 1A)

11. Warranty and Product Registration

3-Year Limited Warranty

TRIPP LITE warrants its products to be free from defects in materials and workmanship for a period of three (3) years from the date of initial purchase. TRIPP LITE's obligation under this warranty is limited to repairing or replacing (at its sole option) any such defective products. To obtain service under this warranty, you must obtain a Returned Material Authorization (RMA) number from TRIPP LITE or an authorized TRIPP LITE service center. Products must be returned to TRIPP LITE or an authorized TRIPP LITE service center with transportation charges prepaid and must be accompanied by a brief description of the problem encountered and proof of date and place of purchase. This warranty does not apply to equipment, which has been damaged by accident, negligence or misapplication or has been altered or modified in any way.

EXCEPT AS PROVIDED HEREIN, TRIPP LITE MAKES NO WARRANTIES, EXPRESS OR IMPLIED, INCLUDING WARRANTIES OF MERCHANTABILITY AND FITNESS FOR A PARTICULAR PURPOSE.

Some states do not permit limitation or exclusion of implied warranties; therefore, the aforesaid limitation(s) or exclusion(s) may not apply to the purchaser.

EXCEPT AS PROVIDED ABOVE, IN NO EVENT WILL TRIPP LITE BE LIABLE FOR DIRECT, INDIRECT, SPECIAL, INCIDENTAL OR CONSEQUENTIAL DAMAGES ARISING OUT OF THE USE OF THIS PRODUCT, EVEN IF ADVISED OF THE POSSIBILITY OF SUCH DAMAGE. Specifically, TRIPP LITE is not liable for any costs, such as lost profits or revenue, loss of equipment, loss of use of equipment, loss of software, loss of data, costs of substitutes, claims by third parties, or otherwise.

Product Registration

Visit www.tripplite.com/warranty today to register your new Tripp Lite product. You'll be automatically entered into a drawing for a chance to win a FREE Tripp Lite product!*

* No purchase necessary. Void where prohibited. Some restrictions apply. See website for details.

WEEE Compliance Information for Tripp Lite Customers and Recyclers (European Union)



Under the Waste Electrical and Electronic Equipment (WEEE) Directive and implementing regulations, when customers buy new electrical and electronic equipment from Tripp Lite they are entitled to:

- Send old equipment for recycling on a one-for-one, like-for-like basis (this varies depending on the country)
- Send the new equipment back for recycling when this ultimately becomes waste

Tripp Lite has a policy of continuous improvement. Specifications are subject to change without notice.



1111 W. 35th Street, Chicago, IL 60609 USA • www.tripplite.com/support