

# Dual Laser InfraRed (IR) Thermometer

MODEL 42512

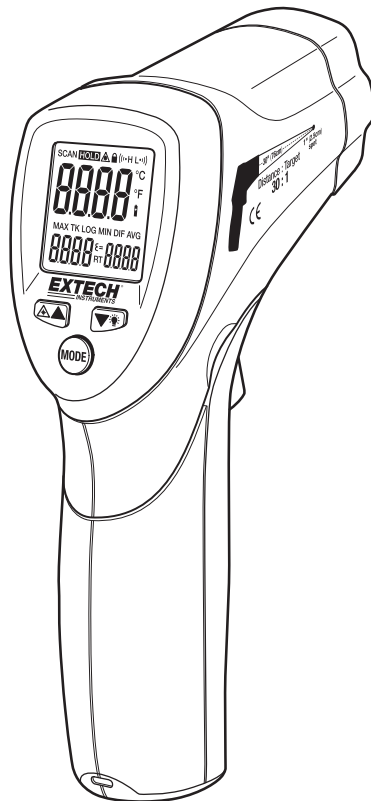

## Introduction

---

Congratulations on your purchase of the Model 42512 IR Thermometer. This Infrared thermometer measures and displays non-contact temperature readings up to 1832°F (1000°C). At 30", built-in dual lasers converge to 1" target spot to insure accurate targeting and temperature measurement. The adjustable emissivity feature allows the IR thermometer to measure the temperature of virtually any surface. Proper use and care of this meter will provide years of reliable service.

## Safety

---

- Use extreme caution when the laser pointer is on
- Do not point the beam toward anyone's eye or allow the beam to strike the eye from a reflective surface
- Do not use the laser near explosive gases or in other potentially explosive areas



## Meter Description

1. Dual Laser pointers
2. LCD Display
3. Function Buttons
4. Measurement Trigger
5. Battery and F/C Switch compartment

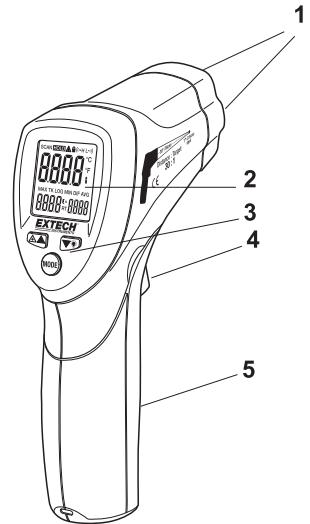

## DISPLAY

1. SCAN, measurement in progress
2. HOLD, last measurement locked in display
3. Laser pointer active
4. Power locked ON
5. High limit alarm
6. Low limit alarm
7. C or F temperature units
8. Main temperature display
9. Low battery icon
10. MAX icon
11. Emissivity setting
12. Emissivity icon
13. Max temperature display

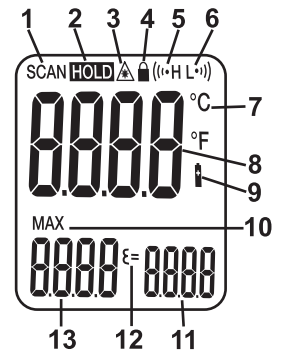

# Operating Instructions



## Temperature Measurements

1. Hold the meter by its handle and point it toward the surface to be measured.
2. Pull and hold the trigger to turn the meter on and begin testing. The temperature reading, MAX temperature reading, the 'SCAN' icon, the emissivity value, and the unit of measure will appear.
3. Release the Trigger and the reading will hold for approximately 7 seconds (HOLD will appear on the LCD) after which the meter will automatically shut off. The only exception to this is if the LOCK mode is set to ON.

**Note:** Select the temperature units (°F/°C) using the switch inside the battery compartment

## Dual Laser Pointer

The dual laser pointers are designed to cross at a distance of 75cm. The spot size at this distance is a 2.5cm diameter and this is the recommended distance to target for most measurements. To turn the lasers on/off:

1. Press and release the Trigger
2. While HOLD is on the display, press the laser button  once to  on the lasers on or off.
3. The laser icon  will appear in the LCD when the laser function is enabled.
4. The status of the laser will be stored in memory and will remain as the "turn-on" condition until changed.

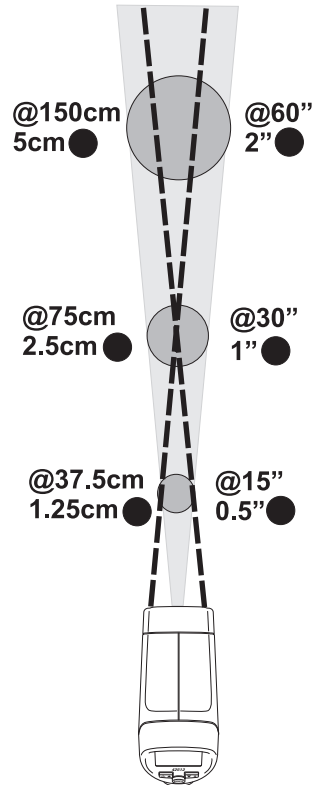

## MAX (maximum) temperature display

The highest reading encountered during a single measurement scan is displayed in the MAX display

## Backlight

1. Press and release the Trigger
2. While HOLD is on the display, press the backlight button  once to turn on the backlight on or off.
3. The backlight will illuminate in the LCD when the feature is enabled.
4. The status of the backlight will be stored in memory and will remain as the “turn-on” condition until changed.
5. Note: The backlight will shorten the battery life. Only use this feature when required.

## The MODE button options

The MODE button is used to access the Emissivity, Lock, High alarm and Low alarm features of the instrument.

1. Press and release the Trigger
2. While HOLD is on the display, press the MODE button to step through and program the following features. A blinking icon indicates the feature is selected.

### (Emissivity Value)

Press the ▲ or ▼ buttons to change the emissivity value.



### (Lock mode On/Off)

Press the ▲ or ▼ buttons to turn the lock feature ON or OFF.

### (High Alarm On/Off)

Press the ▲ or ▼ buttons to turn the High Alarm feature ON or OFF.

### (High Alarm setting)

Press the ▲ or ▼ buttons to set the high alarm limit value in the main display

### (Low Alarm On/Off)

Press the ▲ or ▼ buttons to turn the High Alarm feature ON or OFF.

### (Low Alarm setting)

Press the ▲ or ▼ buttons to set the Low alarm limit value in the main display.

## High and Low Alarm Feature

The meter has a programmable high and low alarm feature. When either alarm point is reached the meter will alert the user via an audible beep and a blinking LCD display icon. The alarm limit is set and the feature is enabled/disabled using the MODE button. The setting is stored and memory and will remain as the “turn-on” condition until changed.

## Temperature Units

The temperature units can be set to °F or °C using the switch located in the battery compartment.

## Lock feature

The LOCK feature disables the Auto Power Off feature for the period of use when selected. The feature is useful for long term temperature monitoring and hands free use. The meter will revert to auto power off if the trigger is pressed during a locked scan.

## Over-range Indication

If the temperature measurement exceeds the specified temperature range, the thermometer will display dashes in place of a temperature reading.

## Battery Replacement

When the low battery symbol  appears on the display, replace the meter's battery (9V). The battery compartment is located behind the panel that surrounds the meter's trigger. Open the compartment by pulling the panel down from the trigger area. Replace the 9V battery and close the battery compartment cover.



You, as the end user, are legally bound (**Battery ordinance**) to return all used batteries and accumulators; **disposal in the household garbage is prohibited!**

You can hand over your used batteries / accumulators at collection points in your community or wherever batteries / accumulators are sold!



**Disposal:** Follow the valid legal stipulations in respect of the disposal of the device at the end of its lifecycle

## IR Measurement Notes

1. The object under test should be larger than the spot (target) size calculated by the field of view diagram (printed on the side of the meter and in this guide).
2. Before measuring, be sure to clean surfaces that are covered with frost, oil, grime, etc.
3. If an object's surface is highly reflective, apply masking tape or flat black paint to the surface before measuring. Allow time for the paint or tape to adjust to the temperature of the surface it is covering.
4. Measurements through transparent surfaces such as glass may not be accurate.
5. Steam, dust, smoke, etc. can obscure measurements.
6. The meter automatically compensates for deviations in ambient temperature. However, it can take up to 30 minutes for the meter to adjust to extremely wide changes.
7. To find a hot spot, aim the meter outside the area of interest then scan across (in an up and down or side to side motion) until the hot spot is located.

## Field of View

The meter's field of view is 30:1. For example, if the meter is 75cm from the target (spot), the diameter of the target must be greater than 2.5cm. Other distances are shown in the field of view diagram. Measurements should normally be made as close as possible to the device under test. The meter can measure from moderate distances but the measurement may be affected by external sources of light. In addition, the spot size may be so large that it encompasses surface areas not intended to be measured.

## Emissivity and IR Measurement Theory

IR Thermometers measure the surface temperature of an object. The thermometer's optics sense emitted, reflected, and transmitted energy. The thermometer's electronics translate the information into a temperature reading which is then displayed on the LCD.

The amount of IR energy emitted by an object is proportional to an object's temperature and its ability to emit energy. This ability is known as emissivity and is based upon the material of the object and its surface finish. Emissivity values range from 0.1 for a very reflective object to 1.00 for a flat black finish. For the Model 42515, the emissivity is adjustable from 0.1 to 1.00. Most organic materials and painted or oxidized surfaces have an emissivity factor of 0.95. When in doubt, set the emissivity to 0.95.

## Emissivity Factors for Common Materials

Material under test	Emissivity	Material under test	Emissivity
Asphalt	0.90 to 0.98	Cloth (black)	0.98
Concrete	0.94	Skin (human)	0.98
Cement	0.96	Leather	0.75 to 0.80
Sand	0.90	Charcoal (powder)	0.96
Soil	0.92 to 0.96	Lacquer	0.80 to 0.95
Water	0.92 to 0.96	Lacquer (matt)	0.97
Ice	0.96 to 0.98	Rubber (black)	0.94
Snow	0.83	Plastic	0.85 to 0.95
Glass	0.90 to 0.95	Timber	0.90
Ceramic	0.90 to 0.94	Paper	0.70 to 0.94
Marble	0.94	Chromium Oxides	0.81
Plaster	0.80 to 0.90	Copper Oxides	0.78
Mortar	0.89 to 0.91	Iron Oxides	0.78 to 0.82
Brick	0.93 to 0.96	Textiles	0.90

## Specifications

Range	-50 to 1000°C (-58 to 1832°F)	
Resolution	0.1° < 1000°, 1° > 1000°	
Accuracy	-50°C to -23°C (-58°F to -10°F) ±7°C/14°F (Typical) -23°C to -2°C (-10°F to 28°F) ±4°C/8°F -2°C to 94°C (28°F to 200°F) ±2.5°C/4.5°F 94°C to 204°C (200°F to 400°F) ±(1.0%rdg + 1°C/2°F) 204°C to 426°C (400°F to 800°F) ±(1.5%rdg + 1°C/ 2°F) 426°C to 1000°C (800°F to 1832°F) ±(3%rdg + 1°C/2°F) Note: Accuracy is specified for the following ambient temperature range: 23 to 25°C (73 to 77°F)	
Emissivity	0.10 to 1.00 adjustable	
Field of View	D/S = Approx. 30:1 ratio (D = distance; S = spot or target)	
Laser pointer	Dual, Class 2 laser < 1mW power; Wavelength is 630 to 670nm	
IR Spectral response	8 to 14 μm (wavelength)	
Repeatability	± 0.5% of reading or ± 1°C (1.8°F) whichever is greater	

### General Specifications

Display	Backlit LCD display with function indicators
Response time	150ms
Over range indication	“-----“
Operating Temperature	0°C to 50°C (32°F to 122°F)
Operating Humidity	10% to 90%RH operating, <80%RH storage.
Storage Temperature	-10 to 60°C (14 to 140°F)
Power Supply	9V battery
Automatic Power Off	7 seconds, with LOCK to disable
Weight	163g/ 5.7 oz.
Dimensions	146 x 104 x 43mm (5.7 x 4 x 1.6")

**Copyright © 2014 FLIR Systems, Inc.**

All rights reserved including the right of reproduction in whole or in part in any form

**www.extech.com**