

PS/2 click™

1. Introduction

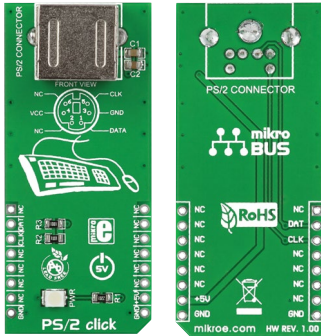

PS/2 click™ is a cost-effective solution for adding keyboard and mouse connectivity to your design. It features a standard 6-pin Mini-DIN PS/2 connector, a **mikroBUS™** host socket, and a power indicator LED. It's an alternative to the USB connector used for modern peripherals. PS/2 click™ communicates with the target board through mikroBUS™ RST (data) and CS (clock) pins. It's designed to use a 5V power supply only.

2. Soldering the headers

Before using your click™ board, make sure to solder 1x8 male headers to both left and right side of the board. Two 1x8 male headers are included with the board in the package.

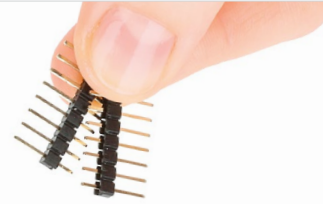

1

2

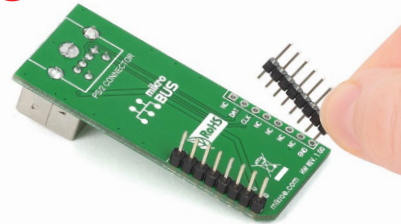

Turn the board upside down so that the bottom side is facing you upwards. Place shorter pins of the header into the appropriate soldering pads.

3

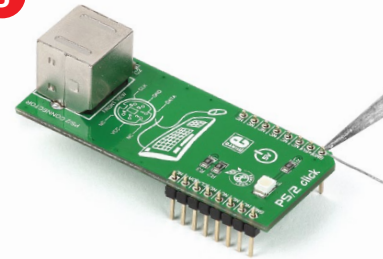

Turn the board upward again. Make sure to align the headers so that they are perpendicular to the board, then solder the pins carefully.

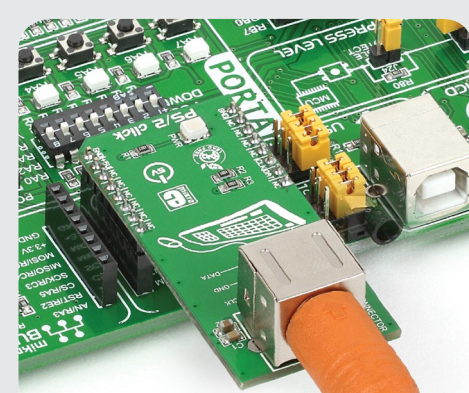

4. Essential features

Even though somewhat superseded by USB, PS/2 connectors are still used. PS/2 click™ is especially suited for connecting vintage or certain modern high-end keyboards and mice. One of the key benefits of PS/2 is that it supports full n-key rollover. It's the ability of the keyboard to handle any number of simultaneous keystrokes.

3. Plugging the board in

Once you have soldered the headers your board is ready to be placed into the desired mikroBUS™ socket. Make sure to align the cut in the lower-right part of the board with the markings on the silkscreen at the mikroBUS™ socket. If all the pins are aligned correctly, push the board all the way into the socket.

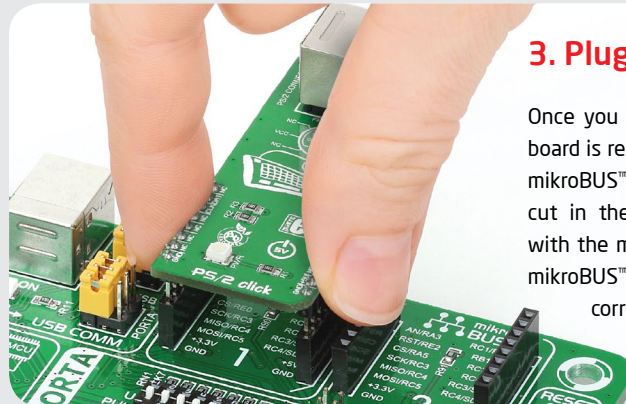

click™
BOARD
www.mikroe.com



PS/2 click Manual
ver. 1.00



5. PS/2 click™ Board Schematic

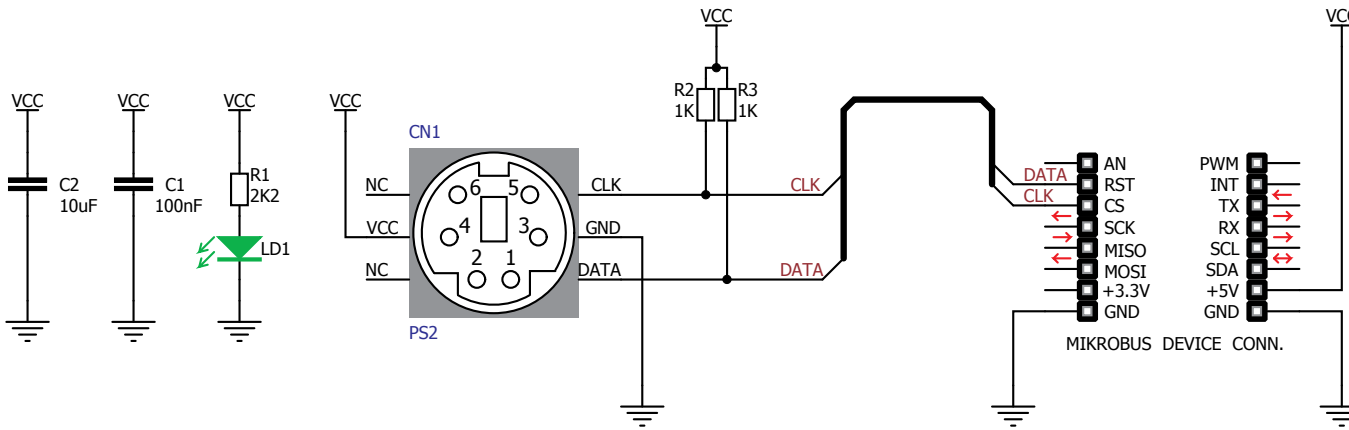

6. PS/2 vs USB

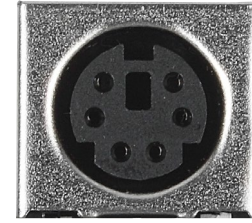

PS/2 connected keyboards have slightly shorter effective scan intervals than their USB counterparts, which makes

them faster. This could be an important consideration in some applications.

7. Code Examples

Once you have done all the necessary preparations, it's time to get your click™ board up and running. We have provided examples for mikroC™, mikroBasic™ and mikroPascal™ compilers on our **Libstock** website. Just download them and you are ready to start.



8. Support

MikroElektronika offers **Free Tech Support** (www.mikroe.com/support/) until the end of the product's lifetime, so if something goes wrong, we're ready and willing to help!