

## Description

The AP1686 is a high performance AC/DC power supply controller for LED lighting application. The device uses Pulse Frequency Modulation (PFM) method to build discontinuous conduction mode (DCM) flyback power supplies.

The AP1686 provides accurate constant voltage, constant current (CV/CC) regulation without requiring an opto-coupler and the secondary control circuitry. It also eliminates the need of loop compensation circuitry while maintaining good stability. The AP1686 can achieve excellent regulation and high average efficiency, yet meets no-load consumption less than 30mW.

It also has an adjustable built-in line compensation function to achieve tight CC.

The AP1686 is available in SOT-23-6 package.

## Pin Assignments

(Top View)

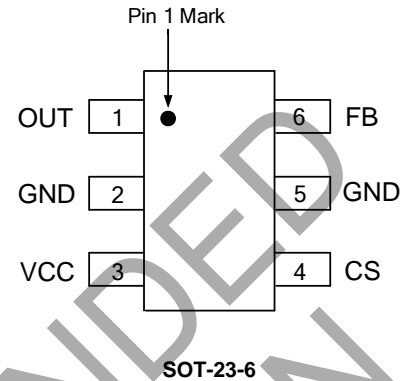

## Features

- Primary Side Control for Tight Constant Current and Constant Voltage
- 30mW No-load Input Power
- Bipolar Junction Transistor (BJT) Driving
- Open Circuit Protection
- Over Voltage Protection
- Short Circuit Protection
- SOT-23-6 Package

## Applications

- LED Driver

NOT RECOMMENDED FOR NEW DESIGN

## Typical Applications Circuit

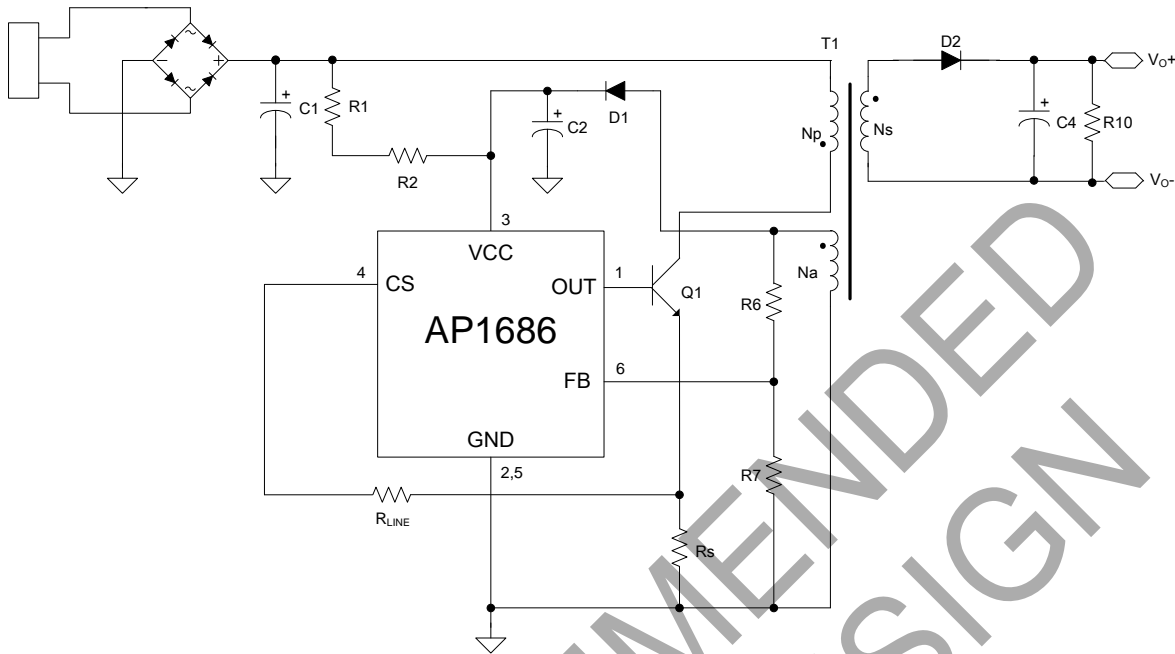

## Pin Descriptions

Pin Number	Pin Name	Function
1	OUT	The OUT pin is used to turn on and turn off the power switch. When turning on the power switch, the OUT pin will output 30mA source current to support the base current of the power BJT. When turning off the power switch, the resistance between the OUT and GND will become to 5Ω
2, 5	GND	The GND pin is the ground of the IC. When the power BJT is turned off, a fast reverse sinking current to the gate of BJT will flow out from this pin. Attention should be paid to in the PCB layout
3	VCC	The VCC pin supplies the power for the IC. In order to get the correct operation of the IC, a capacitor with low ESR should be placed as close as possible to the VCC pin
4	CS	The CS is the current sense pin of the IC. The IC will turn off the power BJT according to the voltage on the CS pin. When the power BJT is on, a current is output from the CS pin which is proportional to the line voltage to realize the function of line compensation
6	FB	The CV and CC regulation are realized based on the voltage sampling of this pin

**Functional Block Diagram**

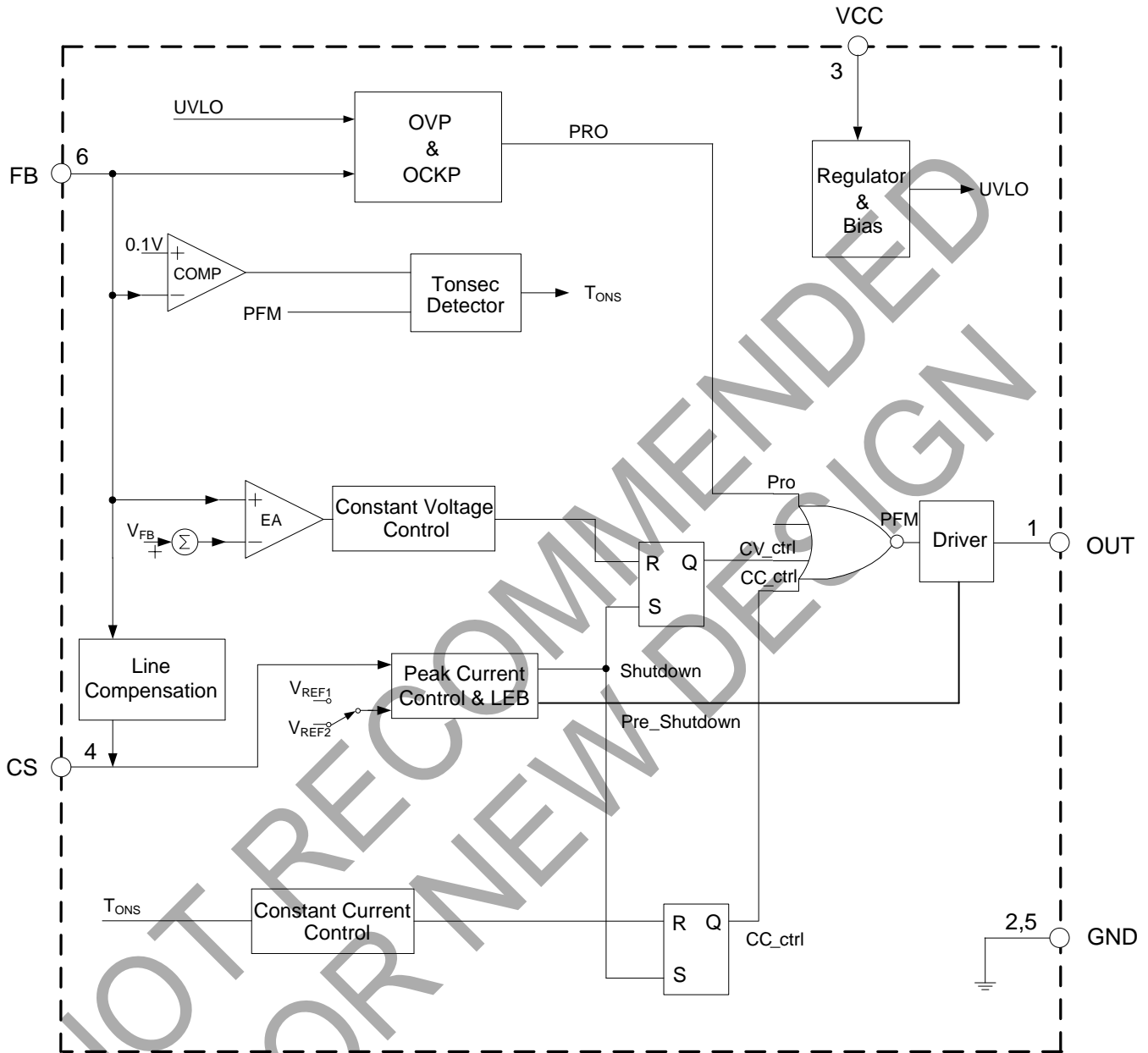

### Absolute Maximum Ratings (Note 1)

Symbol	Parameter	Value	Unit
$V_{CC}$	Supply Voltage	-0.3 to 30	V
–	CS to GND Voltage	-0.3 to 7	V
$V_{FB}$	FB Input Voltage	-40 to 7.5	V
$I_{SOURCE}$	Source Current at OUT Pin	Internally Limited	A
$T_J$	Operating Junction Temperature	+150	°C
$T_{STG}$	Storage Temperature	-65 to +150	°C
$T_{LEAD}$	Lead Temperature (Soldering, 10 sec)	+300	°C
$\theta_{JA}$	Thermal Resistance (Junction to Ambient)	200	°C/W
–	ESD (Human Body Model)	2000	V

Note 1: Stresses greater than those listed under “Absolute Maximum Ratings” may cause permanent damage to the device. These are stress ratings only, and functional operation of the device at these or any other conditions beyond those indicated under “Recommended Operating Conditions” is not implied. Exposure to “Absolute Maximum Ratings” for extended periods may affect device reliability.

NOT RECOMMENDED FOR NEW DESIGN

**Electrical Characteristics** ( $V_{CC} = 15V$ ,  $T_A = +25^\circ C$ , unless otherwise specified.)

Symbol	Parameter	Conditions	Min	Typ	Max	Unit		
<b>UVLO SECTION</b>								
$V_{TH}(ST)$	Startup Threshold	–	13	15.5	18	V		
$V_{OPR}(MIN)$	Minimal Operating Voltage	–	3	3.5	4.5	V		
<b>STANDBY CURRENT SECTION</b>								
$I_{ST}$	Startup Current	$V_{CC} = V_{TH}(ST) - 1V$ , Before startup	0	0.2	0.6	μA		
$I_{CC}(OPR)$	Operating Current	Static current	250	400	600			
<b>DRIVE OUTPUT SECTION</b>								
$I_{SINK}$	Output Current	Sink	Apply 1V @OUT pin		200	300	500	mA
$I_{SOURCE}$		Source	–	24	30	45	mA	
<b>CURRENT SENSE SECTION</b>								
$V_{CS}$	Current Sense Threshold Voltage	–	440	500	550	mV		
$\frac{\Delta V_{cs,eq}}{V_{cs,eq}}$	Equivalent Current Sense Voltage Accuracy (Note 2)	–	–	–	4	%		
$t_{LEB}$	Leading Edge Blanking	The minimum power switch turn on time	300	475	720	ns		
<b>FEEDBACK INPUT SECTION</b>								
$R_{FB}$	Input Resistance of FB Pin	$V_{FB} = 4V$	1	1.6	2	MΩ		
$V_{FB}$	Feedback Threshold	–	3.7	3.974	4.21	V		
<b>LINE COMPENSATION SECTION</b>								
$g_m$	Line Compensation Transconductance (Note 2)	–	1.14	1.43	1.72	μs		
<b>PROTECTION SECTION</b>								
$V_{FB}(OVP)$	Over Voltage Protection	–	6.5	7.5	8.5	V		
$tonp(MAX)$	Maximum On Time of Primary Side	–	11	18	50	μs		

Note 2: The output current is given by  $I_{OUT} = \frac{V_{cs,eq}}{R_{cs}} \times \frac{N_p}{N_s}$

**Performance Characteristics**

**Operating Current vs. Supply Voltage**

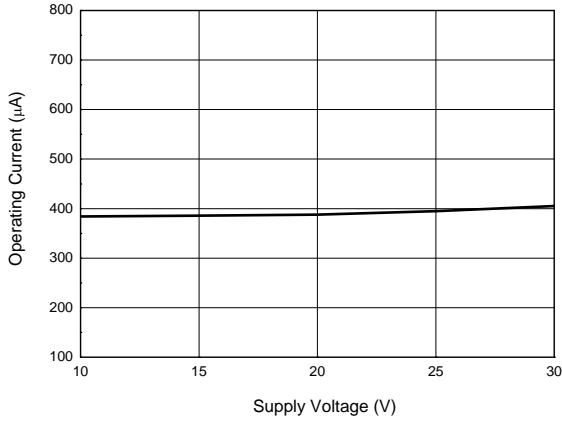

**Source Current vs. Supply Voltage**

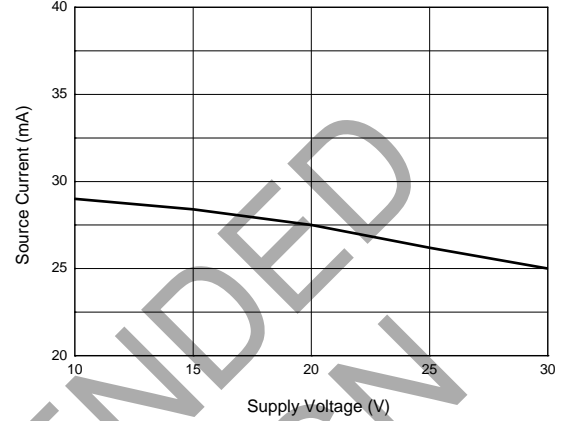

**Minimal Operating Voltage vs. Ambient Temperature**

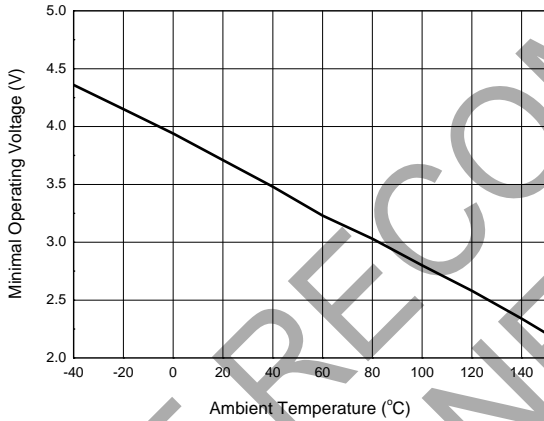

**Operating Current vs. Ambient Temperature**

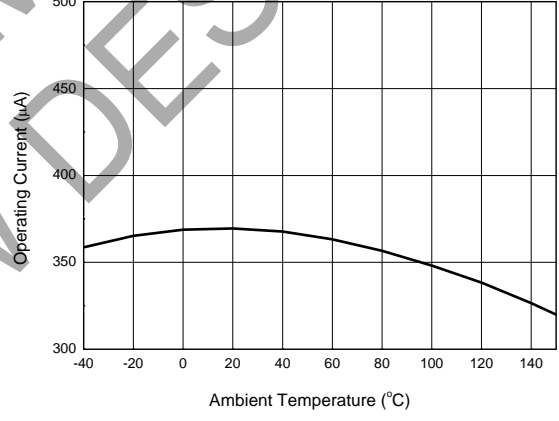

**Start-up Voltage vs. Ambient Temperature**

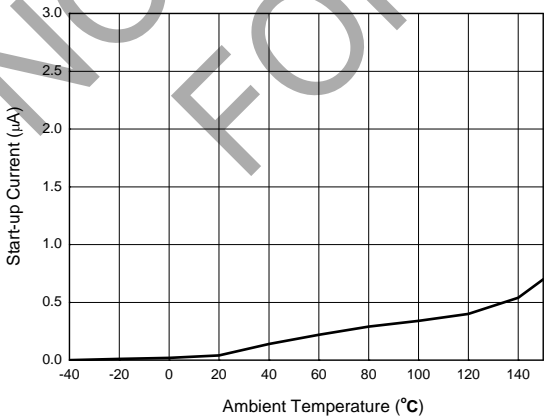

**Start-up Voltage vs. Ambient Temperature**

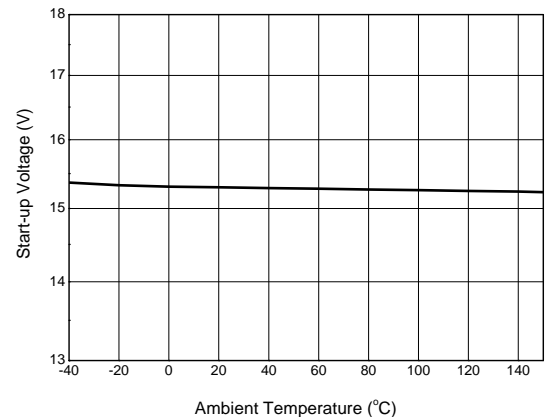

**Performance Characteristics (Cont.)**

**FB Input Resistance vs. Ambient Temperature**

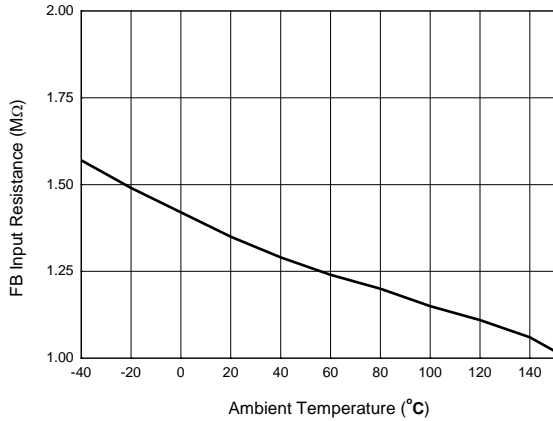

**Source Current vs. Ambient Temperature**

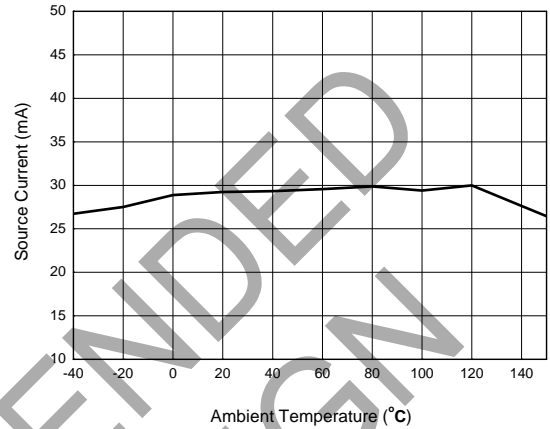

**Current Sense Voltage vs. Ambient Temperature**

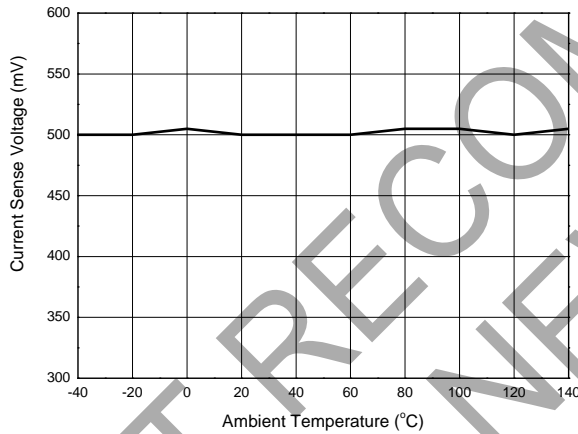

**Primary Side Maximum On Time vs. Ambient Temperature**

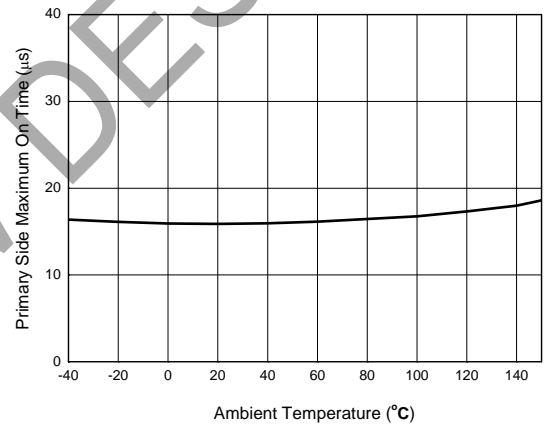

**LEB vs. Ambient Temperature**

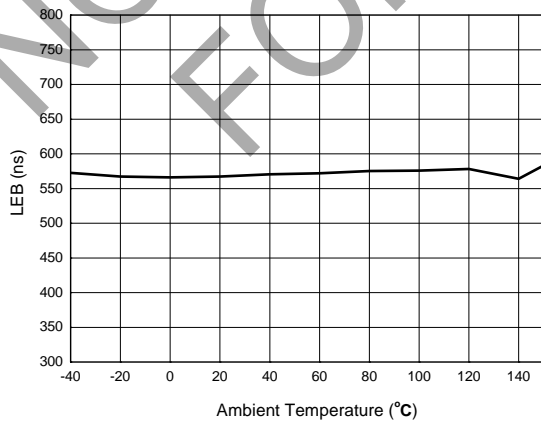

**Ordering Information**

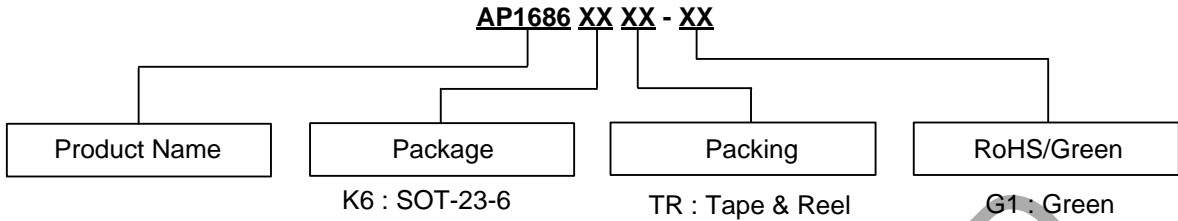

Package	Temperature Range	Part Number	Marking ID	Packing
SOT-23-6	-40 to +85°C	AP1686K6TR-G1	GBQ	Tape & Reel

**Package Outline Dimensions** (All dimensions in mm(inch).)

(1) Package Type: SOT-23-6

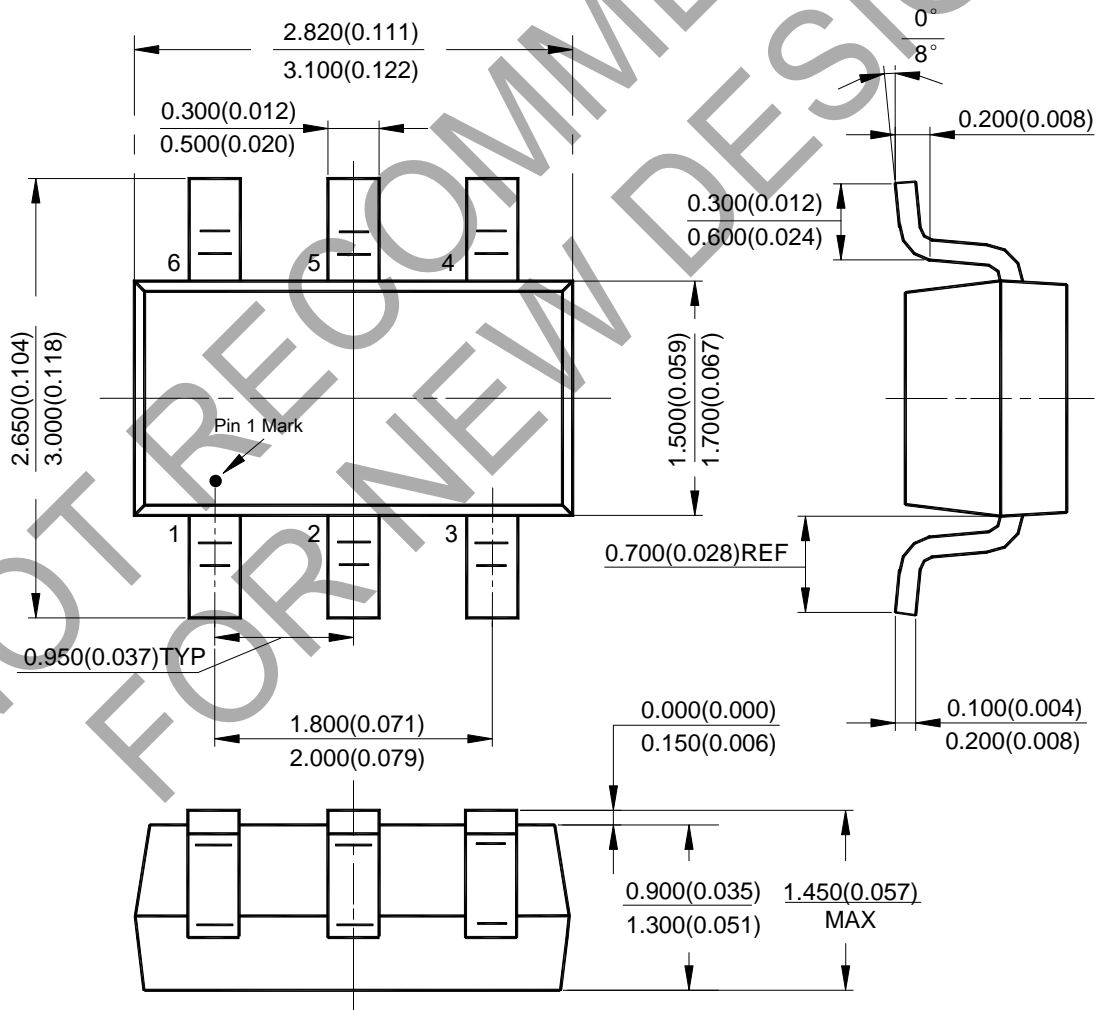



**Suggested Pad Layout**

(1) Package Type: SOT-23-6

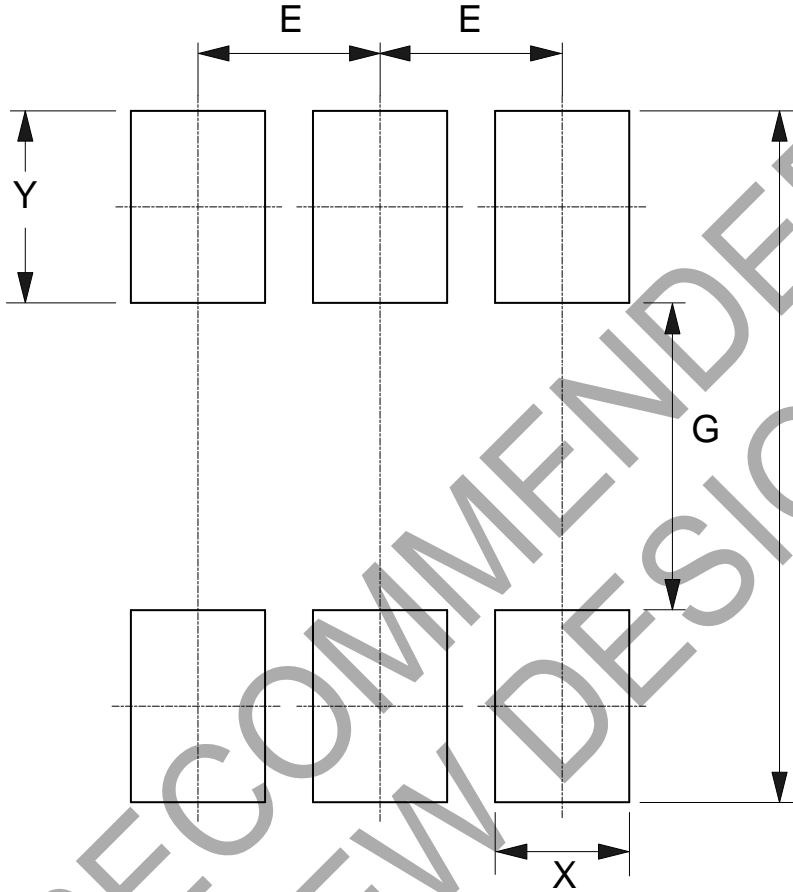

Dimensions	Z (mm)/(inch)	G (mm)/(inch)	X (mm)/(inch)	Y (mm)/(inch)	E (mm)/(inch)
Value	3.600/0.142	1.600/0.063	0.700/0.028	1.000/0.039	0.950/0.037

#### **IMPORTANT NOTICE**

DIODES INCORPORATED MAKES NO WARRANTY OF ANY KIND, EXPRESS OR IMPLIED, WITH REGARDS TO THIS DOCUMENT, INCLUDING, BUT NOT LIMITED TO, THE IMPLIED WARRANTIES OF MERCHANTABILITY AND FITNESS FOR A PARTICULAR PURPOSE (AND THEIR EQUIVALENTS UNDER THE LAWS OF ANY JURISDICTION).

Diodes Incorporated and its subsidiaries reserve the right to make modifications, enhancements, improvements, corrections or other changes without further notice to this document and any product described herein. Diodes Incorporated does not assume any liability arising out of the application or use of this document or any product described herein; neither does Diodes Incorporated convey any license under its patent or trademark rights, nor the rights of others. Any Customer or user of this document or products described herein in such applications shall assume all risks of such use and will agree to hold Diodes Incorporated and all the companies whose products are represented on Diodes Incorporated website, harmless against all damages.

Diodes Incorporated does not warrant or accept any liability whatsoever in respect of any products purchased through unauthorized sales channel. Should Customers purchase or use Diodes Incorporated products for any unintended or unauthorized application, Customers shall indemnify and hold Diodes Incorporated and its representatives harmless against all claims, damages, expenses, and attorney fees arising out of, directly or indirectly, any claim of personal injury or death associated with such unintended or unauthorized application.

Products described herein may be covered by one or more United States, international or foreign patents pending. Product names and markings noted herein may also be covered by one or more United States, international or foreign trademarks.

This document is written in English but may be translated into multiple languages for reference. Only the English version of this document is the final and determinative format released by Diodes Incorporated.

#### **LIFE SUPPORT**

Diodes Incorporated products are specifically not authorized for use as critical components in life support devices or systems without the express written approval of the Chief Executive Officer of Diodes Incorporated. As used herein:

A. Life support devices or systems are devices or systems which:

1. are intended to implant into the body, or
2. support or sustain life and whose failure to perform when properly used in accordance with instructions for use provided in the labeling can be reasonably expected to result in significant injury to the user.

B. A critical component is any component in a life support device or system whose failure to perform can be reasonably expected to cause the failure of the life support device or to affect its safety or effectiveness.

Customers represent that they have all necessary expertise in the safety and regulatory ramifications of their life support devices or systems, and acknowledge and agree that they are solely responsible for all legal, regulatory and safety-related requirements concerning their products and any use of Diodes Incorporated products in such safety-critical, life support devices or systems, notwithstanding any devices- or systems-related information or support that may be provided by Diodes Incorporated. Further, Customers must fully indemnify Diodes Incorporated and its representatives against any damages arising out of the use of Diodes Incorporated products in such safety-critical, life support devices or systems.

Copyright © 2018, Diodes Incorporated

[www.diodes.com](http://www.diodes.com)