

## GaAs MMIC DOUBLE-BALANCED MIXER, 6 - 20 GHz



### Typical Applications

The HMC144LH5 is ideal for:

- Telecom Infrastructure
- Test Instrumentation
- Military Radio, Radar & ECM
- Space Systems

### Features

- Input IP3: +24 dBm
- LO/RF Isolation: 35 dB
- IF Bandwidth: DC to 3 GHz
- RoHS Compliant Hermetic SMT Package, 25 mm<sup>2</sup>
- Screening to MIL-PRF-38535 (Class B or S) Available

### Functional Diagram

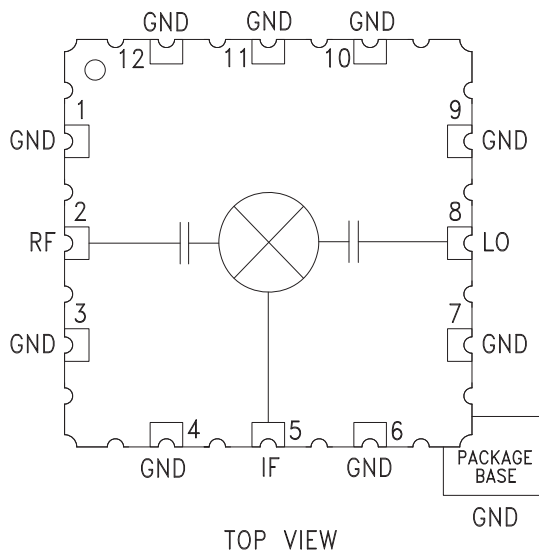

### General Description

The HMC144LH5 is a Double-Balanced MMIC Mixer housed in a hermetic SMT leadless package which can be used as an upconverter or downconverter from 6 to 20 GHz. Broadband operation and excellent isolations are provided by on-chip baluns, while no external components or DC bias are required. The HMC144LH5 is a more reliable alternative to hybrid diode mixers, assuring consistent conversion loss and isolation performance over multiple production lots. The HMC144LH5 allows the use of surface mount manufacturing techniques and is suitable for high reliability, military, industrial and space applications.

### Electrical Specifications, $T_A = +25^\circ\text{C}$

| Parameter                | IF = 100 MHz<br>LO = +20 dBm |      |      |         |      |      | Units |
|--------------------------|------------------------------|------|------|---------|------|------|-------|
|                          | Min.                         | Typ. | Max. | Min.    | Typ. | Max. |       |
| Frequency Range, RF & LO | 6 - 12                       |      |      | 12 - 20 |      |      | GHz   |
| Frequency Range, IF      | DC - 3                       |      |      | DC - 3  |      |      | GHz   |
| Conversion Loss          |                              | 9.5  | 11.5 |         | 11   | 13   | dB    |
| Noise Figure (SSB)       |                              | 9.5  | 11.5 |         | 11   | 13   | dB    |
| LO to RF Isolation       | 23                           | 35   |      | 23      | 35   |      | dB    |
| LO to IF Isolation       | 10                           | 20   |      | 10      | 20   |      | dB    |
| RF to IF Isolation       | 12                           | 25   |      | 12      | 22   |      | dB    |
| IP3 (Input)              |                              | 24   |      |         | 24   |      | dBm   |
| 1 dB Compression (Input) | 12                           | 15   |      | 12      | 15   |      | dBm   |

\* Unless otherwise noted, all measurements performed as downconverter, IF= 100 MHz.

**GaAs MMIC DOUBLE-BALANCED MIXER, 6 - 20 GHz**



**Conversion Gain vs. Temperature @ LO = +20 dBm**

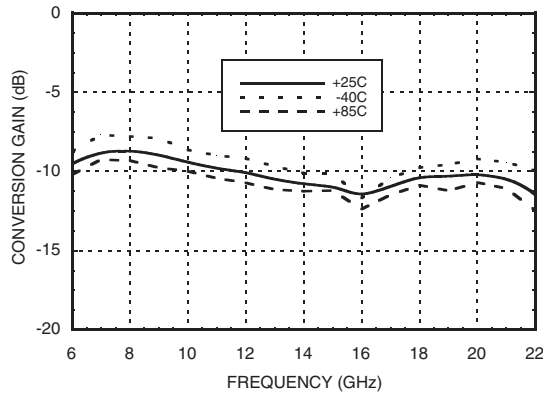

**Isolation @ LO = +20 dBm**

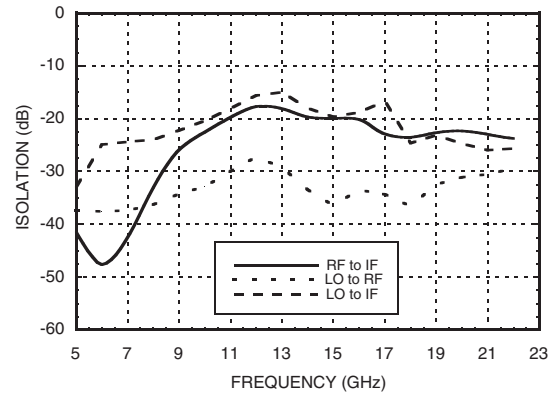

**Conversion Gain vs. LO Drive**

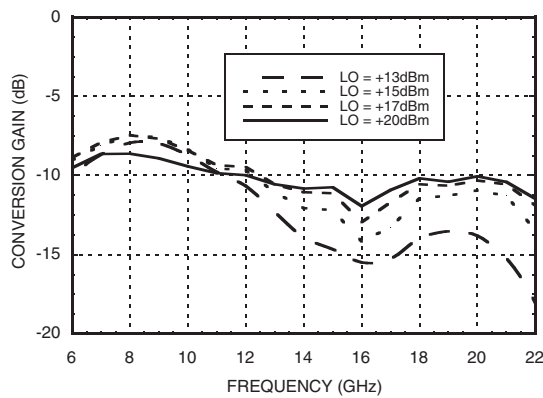

**Return Loss @ LO = +20 dBm**

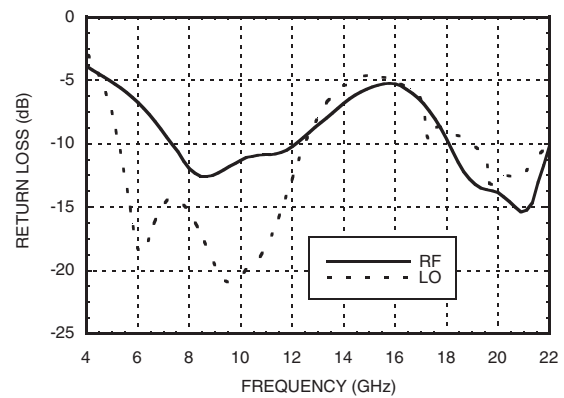

**IF Bandwidth @ LO = +20 dBm**

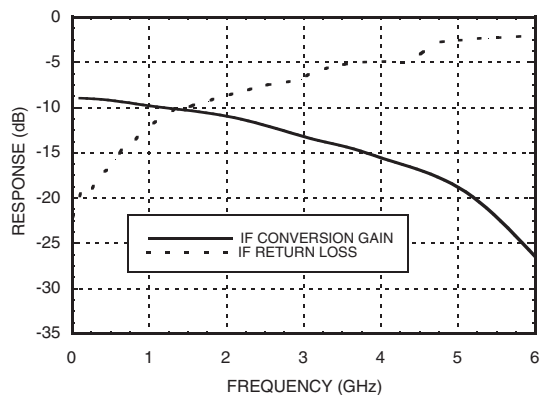

**Upconverter Performance Conversion Gain @ LO = +20 dBm**

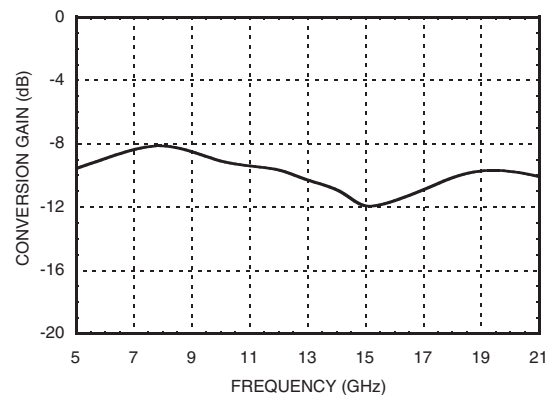

Information furnished by Analog Devices is believed to be accurate and reliable. However, no responsibility is assumed by Analog Devices for its use, nor for any infringements of patents or other rights of third parties that may result from its use. Specifications subject to change without notice. No license is granted by implication or otherwise under any patent or patent rights of Analog Devices. Trademarks and registered trademarks are the property of their respective owners.

For price, delivery, and to place orders: Analog Devices, Inc., One Technology Way, P.O. Box 9106, Norwood, MA 02062-9106 Phone: 781-329-4700 • Order online at [www.analog.com](http://www.analog.com) Application Support: Phone: 1-800-ANALOG-D



**GaAs MMIC DOUBLE-BALANCED MIXER, 6 - 20 GHz**

**Input IP3 vs. LO Drive\***

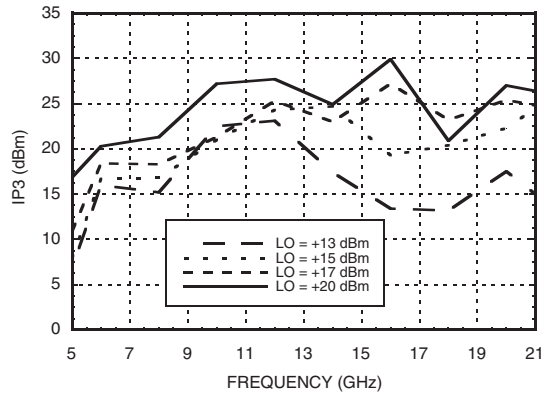

**Input IP3 vs. Temperature @ LO = +20 dBm\***

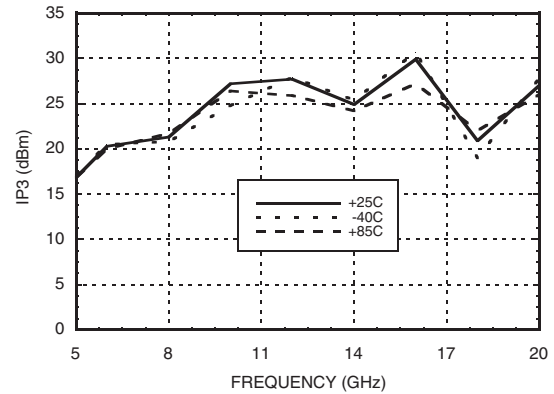

**Input IP2 vs. LO Drive \***

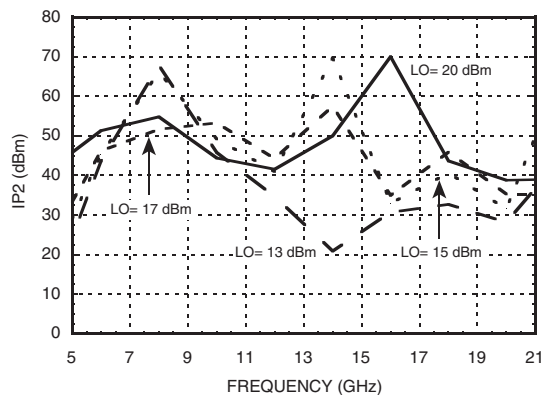

**Input P1dB vs. Temperature @ LO = +20 dBm**

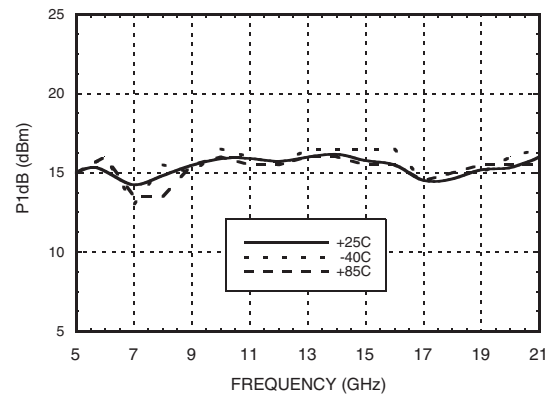

**MxN Spurious @ IF Port**

| mRF | nLO |     |    |     |     |
|-----|-----|-----|----|-----|-----|
|     | 0   | 1   | 2  | 3   | 4   |
| 0   | XX  | -23 | 18 | 2   | 23  |
| 1   | 8   | 0   | 25 | 14  | 37  |
| 2   | 65  | 65  | 62 | 80  | 62  |
| 3   | 85  | 86  | 83 | 90  | 82  |
| 4   | 86  | 87  | 95 | 100 | 105 |

RF = 12 GHz @ -10 dBm  
 LO = 12.1 GHz @ 20 dBm  
 All values in dBc relative to the IF power level.  
 Measured as downconverter.

**Harmonics of LO**

| LO Freq. (GHz) | nLO Spur @ RF Port |    |     |     |
|----------------|--------------------|----|-----|-----|
|                | 1                  | 2  | 3   | 4   |
| 6              | 37                 | 34 | 56  | 46  |
| 8              | 36                 | 38 | 61  | 50  |
| 10             | 33                 | 43 | 66  | 63  |
| 12             | 27                 | 37 | 48  | 60  |
| 14             | 35                 | 41 | 50  | N/A |
| 16             | 34                 | 42 | 58  | N/A |
| 18             | 35                 | 55 | N/A | N/A |
| 20             | 30                 | 54 | N/A | N/A |

LO = +20 dBm  
 All values in dBc below input LO level @ RF port.

\* Two-tone input power = 0 dBm each tone, 1 MHz spacing.

## GaAs MMIC DOUBLE-BALANCED MIXER, 6 - 20 GHz



### Absolute Maximum Ratings

|                                                                             |                |
|-----------------------------------------------------------------------------|----------------|
| RF / IF Input                                                               | +15 dBm        |
| LO Drive                                                                    | +27 dBm        |
| IF DC Current                                                               | ±2 mA          |
| Channel Temperature                                                         | 150 °C         |
| Continuous P <sub>diss</sub> (T = 85 °C)<br>(derate 9.83 mW/°C above 85 °C) | 640 mW         |
| Thermal Resistance (R <sub>TH</sub> )<br>(Channel to package bottom)        | 101.7 °C/W     |
| Storage Temperature                                                         | -65 to +150 °C |
| Operating Temperature                                                       | -40 to +85 °C  |
| ESD Sensitivity (HBM)                                                       | Class 1A       |



ELECTROSTATIC SENSITIVE DEVICE  
OBSERVE HANDLING PRECAUTIONS

### Outline Drawing

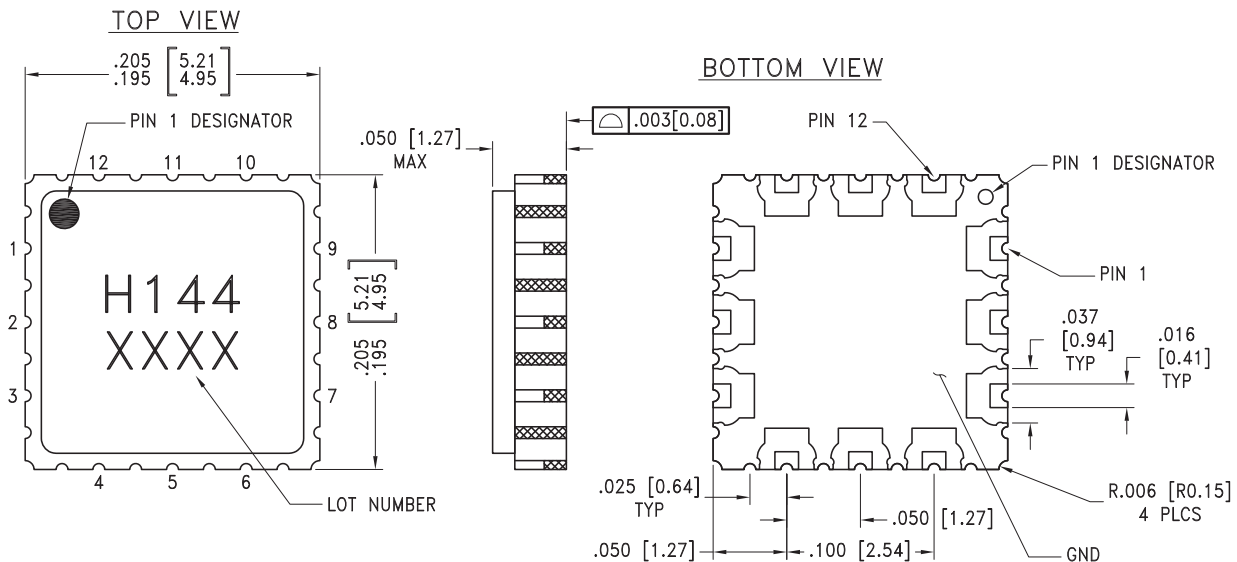

NOTES:

1. PACKAGE BODY MATERIAL: CERAMIC & KOVAR
2. LEAD AND GROUND PADDLE PLATING: GOLD 40-80 MICROINCHES
3. DIMENSIONS ARE IN INCHES [MILLIMETERS].
4. LEAD SPACING TOLERANCE IS NON-CUMULATIVE.
5. PAD BURR LENGTH 0.15mm MAX. PAD BURR HEIGHT 0.25mm MAX
6. ALL GROUND LEADS AND GROUND PADDLE MUST BE SOLDERED TO PCB RF GROUND.

## GaAs MMIC DOUBLE-BALANCED MIXER, 6 - 20 GHz



### Pin Descriptions

| Pin Number          | Function | Description                                                                                                                                                                                                                                                                                                                                             | Interface Schematic |
|---------------------|----------|---------------------------------------------------------------------------------------------------------------------------------------------------------------------------------------------------------------------------------------------------------------------------------------------------------------------------------------------------------|---------------------|
| 1, 3, 4, 6, 7, 9-12 | GND      | These pins and package bottom must be connect to RF/DC ground.                                                                                                                                                                                                                                                                                          |                     |
| 2                   | RF       | This pin is AC coupled and matched to 50 Ohms.                                                                                                                                                                                                                                                                                                          |                     |
| 5                   | IF       | This pin is DC coupled. For applications not requiring operation to DC, this port should be DC blocked externally using a series capacitor whose value has been chosen to pass the necessary IF frequency range. For operation to DC, this pin must not source/sink more than 2 mA of current or die non-function and possible die failure will result. |                     |
| 8                   | LO       | This pin is AC coupled and matched to 50 Ohms.                                                                                                                                                                                                                                                                                                          |                     |



v00.1206

## GaAs MMIC DOUBLE-BALANCED MIXER, 6 - 20 GHz

### Evaluation PCB

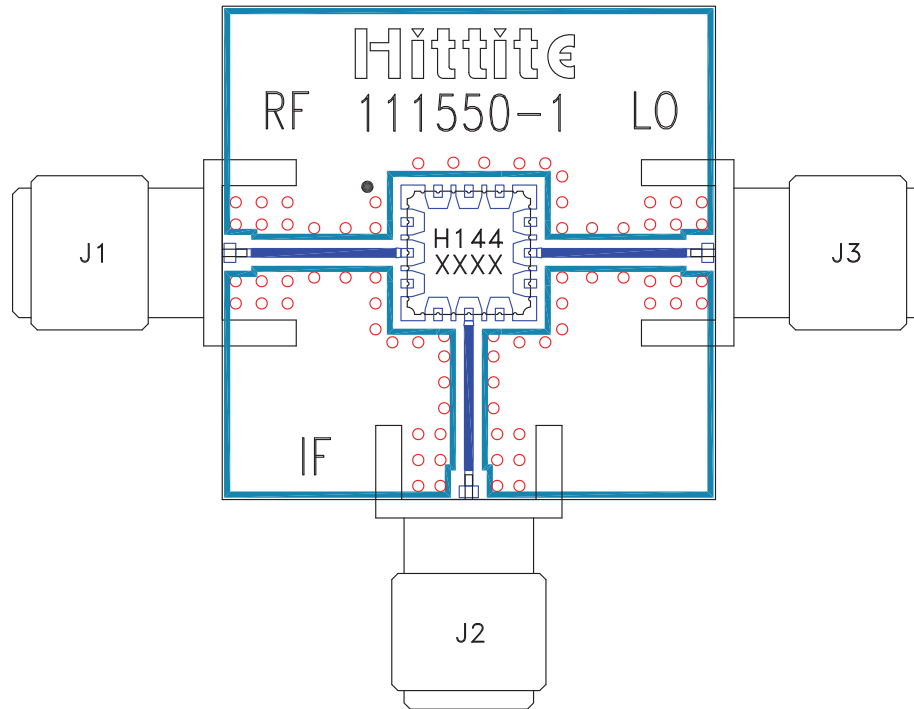

### List of Materials for Evaluation PCB 116588 [1]

| Item    | Description                     |
|---------|---------------------------------|
| J1 - J3 | PCB Mount SMA RF Connector, SRI |
| U1      | HMC144LH5                       |
| PCB [2] | 111550 Evaluation Board         |

[1] Reference this number when ordering complete evaluation PCB

[2] Circuit Board Material: Rogers 4350

The circuit board used in the final application should use RF circuit design techniques. Signal lines should have 50 ohm impedance while the package ground leads and exposed paddle should be connected directly to the ground plane similar to that shown. A sufficient number of via holes should be used to connect the top and bottom ground planes. The evaluation circuit board shown is available from Hittite upon request.