

Micropower Ultrasensitive 3D Hall-Effect Switch

FEATURES AND BENEFITS

- True 3D sensing
- Omnipolar operation with either north or south pole
- 2.5 to 5.5 V operation
- Low supply current
- High sensitivity, B_{OP} typically 25 G
- Chopper-stabilized offset cancellation
 - Superior temperature stability
 - Extremely low switchpoint drift
 - Insensitive to physical stress
- Solid-state reliability
- Choice of output format
 - Separate X, Y, and Z outputs
 - Combined (X+Y+Z) output
- Tiny SOT-23 packages

DESCRIPTION

The A1266 integrated circuit is an ultrasensitive Hall-effect switch with 3D omnipolar magnetic actuation. The single silicon chip includes: three Hall plates, multiplexer, small-signal amplifier, chopper stabilization, Schmitt trigger, and NMOS output transistors. The device outputs turn on when a magnetic field of sufficient strength is applied to the sensor in any orientation. Removal of the magnetic field will turn the output off.

Two versions of the A1266 offer a choice of output format: separate X, Y, and Z outputs, or a combined X+Y+Z output. The low operating supply voltage, 2.5 to 5.5 V, and unique clocking algorithm assist in reducing the average power consumption, making it ideal for battery operation (e.g., the power consumption is less than 25 μ W with a 3.3 V supply).

The small geometries of the BiCMOS process allow for ultrasmall packages suitable for even space-constrained applications. In this case, a modified SOT23-W surface-mount package is available in a 3-pin (combined output) or a 5-pin (separate outputs) configuration, magnetically optimized for use in a variety of orientations. The packages are lead (Pb) free and RoHS-compliant, with 100% matte-tin leadframe plating.

PACKAGES:

5-Pin SOT23-W



3-Pin SOT23-W

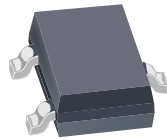

Not to scale

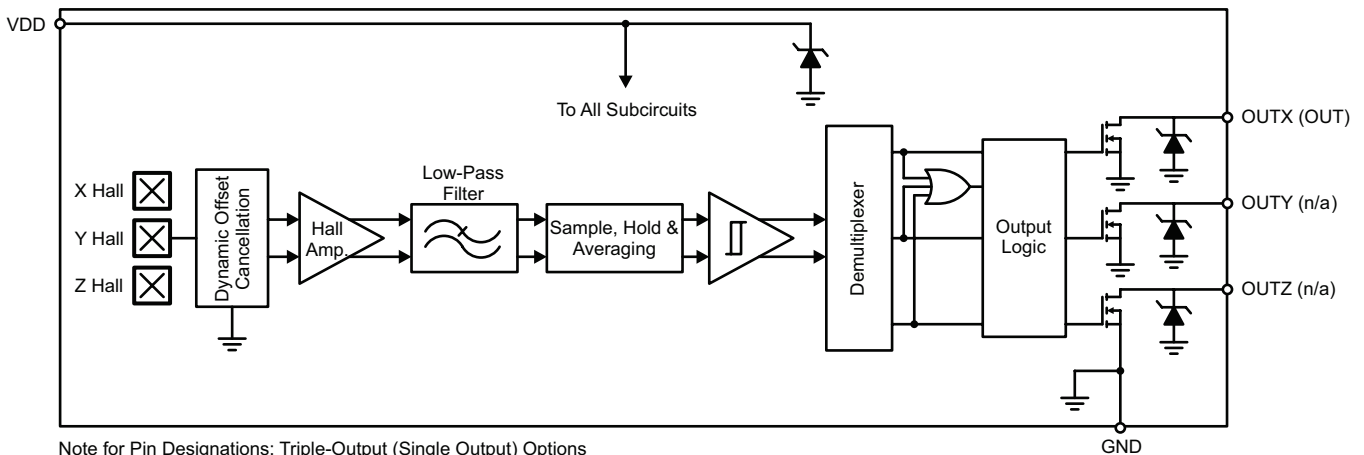

Functional Block Diagram

SPECIFICATIONS



SELECTION GUIDE

Part Number	Packing	Package	Description
A1266ELHLT-T	7-in. reel, 3000 pieces/reel	5-pin SOT23-W	3 Outputs of X, Y, and Z
A1266ELHLX-T	13-in. reel, 10000 pieces/reel	5-pin SOT23-W	3 Outputs of X, Y, and Z
A1266ELHLT-SO3-T	7-in. reel, 3000 pieces/reel	3-pin SOT23-W	Single Output of OR (X, Y, and Z)
A1266ELHLX-SO3-T	13-in. reel, 10000 pieces/reel	3-pin SOT23-W	Single Output of OR (X, Y, and Z)
A1266ELHLT-SQ-T*	7-in. reel, 3000 pieces/reel	5-pin SOT23-W	Single Output of OR (X, Y, and Z)
A1266ELHLX-SQ-T*	13-in. reel, 10000 pieces/reel	5-pin SOT23-W	Single Output of OR (X, Y, and Z)

* These parts are in production but have been determined to be NOT FOR NEW DESIGN. This classification indicates that sale of this device is currently restricted to existing customer applications. Samples are no longer available.

ABSOLUTE MAXIMUM RATINGS

Characteristic	Symbol	Notes	Rating	Unit
Forward Supply Voltage	V_{DD}		5.5	V
Reverse Supply Voltage	V_{RDD}		-0.3	V
Magnetic Flux Density	B		Unlimited	G
Output Off Voltage	V_{OUT}		5.5	V
Reverse Output Voltage	V_{ROUT}		-0.3	V
Continuous Output Current	I_{OUT}		3	mA
Reverse Output Current	I_{ROUT}		-3	mA
Operating Ambient Temperature	T_A	Range E	-40 to 85	°C
Maximum Junction Temperature	$T_{J(MAX)}$		165	°C
Storage Temperature	T_{stg}		-65 to 170	°C

PINOUT DIAGRAMS AND TERMINAL LIST TABLE

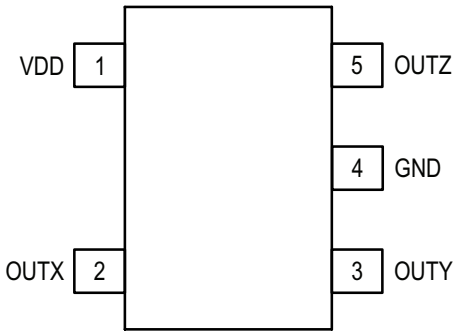

**A1266ELHLT-T,
A1266ELHLX-T
Pinouts**

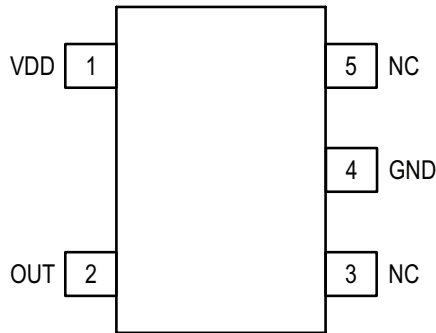

**A1266ELHLT-SO-T,
A1266ELHLX-SO-T
Pinouts**

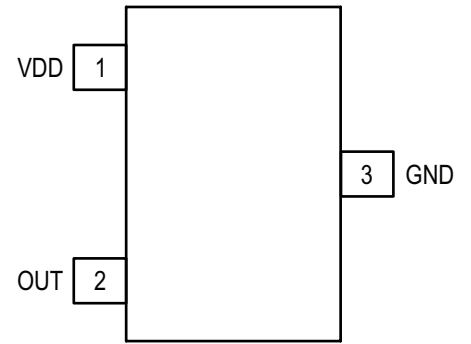

**A1266ELHLT-SO3-T,
A1266ELHLX-SO3-T
Pinouts**

Terminal List Table

Pin Number	A1266ELHLT-T, A1266ELHLX-T		A1266ELHLT-SO-T, A1266ELHLH-SO-T		A1266ELHLT-SO3-T, A1266ELHLX-SO3-T	
	Symbol	Description	Symbol	Description	Symbol	Description
1	VDD	Power Supply	VDD	Power Supply	VDD	Power Supply
2	OUTX	Output of X magnetic field direction	OUT	X+Y+Z Output	OUT	X+Y+Z output
3	OUTY	Output of Y magnetic field direction	NC	No connection	GND	Ground
4	GND	Ground	GND	Ground	-	-
5	OUTZ	Output of Z magnetic field direction	NC	No connection	-	-

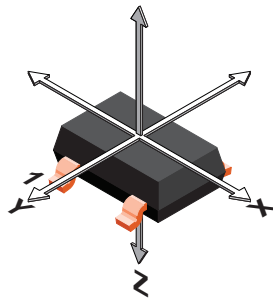

THERMAL CHARACTERISTICS

A1266 power consumption is extremely low. On-chip power dissipation will not be an issue under normal operating conditions.

Characteristic	Symbol	Notes	Rating	Unit
Package Thermal Resistance	$R_{\theta JA}$	Package LH-3, 2-layer PCB with 0.463 in. ² of copper area, each side connected by thermal vias	110	°C/W
		Package LH-5, 4-layer board based on the JEDEC standard.	124	°C/W

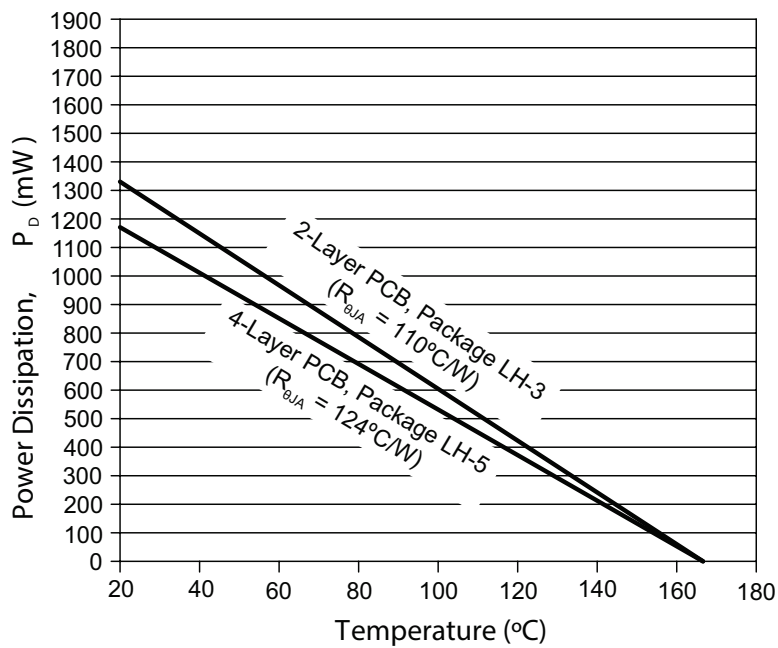

Maximum Power Dissipation versus Ambient Temperature

ELECTRICAL CHARACTERISTICS: Valid over $V_{DD} = 2.5$ to 5 V and full operating temperature range, unless otherwise specified

Characteristics	Symbol	Test Conditions	Min.	Typ. [1]	Max.	Unit
Supply Voltage	V_{DD}	Operating, $T_J < 165^\circ\text{C}$	2.5	3.3	5.5	V
Output Leakage Current	I_{OUTOFF}	$B < B_{RP}$	–	–	10	μA
Output On Voltage	$V_{OUT(SAT)}$	$I_{OUT} = 2 \text{ mA}$, $B > B_{OP}$	–	50	500	mV
Awake Time	t_{awake}		–	300	–	μs
Mode Cycle Period	t_{period}		–	165	–	ms
Chopping Frequency	f_C		–	800	–	kHz
Supply Current	$I_{DD(EN)}$	Chip Awake (Enabled)	–	–	3.6	mA
	$I_{DD(DIS)}$	Chip Asleep (Disabled), $V_{DD} = 2.5 \text{ V}$, $T_A = 25^\circ\text{C}$	–	–	15	μA
	$I_{DD(AVG)}$	$V_{DD} = 2.5 \text{ V}$, $T_A = 25^\circ\text{C}$	–	7.8	21	μA
		$V_{DD} = 5 \text{ V}$, $T_A = 25^\circ\text{C}$	–	9.5	40	μA

MAGNETIC CHARACTERISTICS: Valid over $V_{DD} = 2.5$ to 5 V and full operating temperature range, unless otherwise specified

Characteristics	Symbol	Test Conditions	Min.	Typ.	Max.	Unit [2]
Operate Point [3]	B_{OPS}	South pole to left, bottom, or branded face side (see Figure 1)	–	25	40	G
	B_{OPN}	North pole to left, bottom, or branded face side (see Figure 1)	–40	–25	–	G
Release Point [3]	B_{RPS}	South pole to left, bottom, or branded face side (see Figure 1)	5	17.5	–	G
	B_{RPN}	North pole to left, bottom, or branded face side (see Figure 1)	–	–17.5	–5	G
Hysteresis [3]	B_{HYS}	$B_{OPS} - B_{RPS}$, $B_{OPN} - B_{RPN}$	–	7.5	–	G

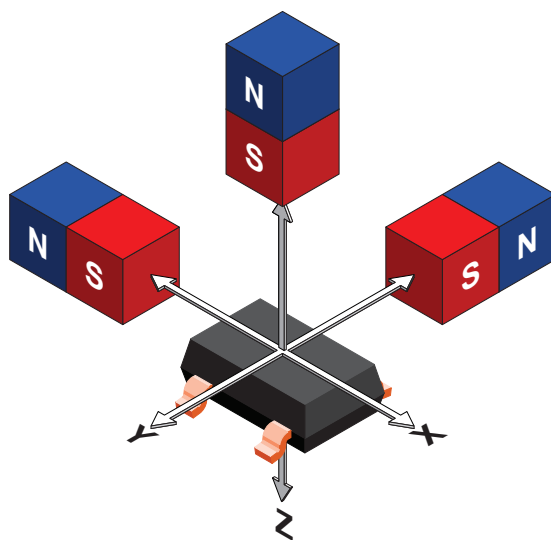

Figure 1: Three Dimensions of Magnet Orientation.
Applied field may be either north or south polarity.

[1] Typical data are at $T_A = 25^\circ\text{C}$ and $V_{DD} = 3.3 \text{ V}$ (unless otherwise noted).

[2] 1 G (gauss) = 0.1 mT (millitesla)

[3] Applicable to all directions (X, Y, and Z)

CHARACTERISTIC DATA

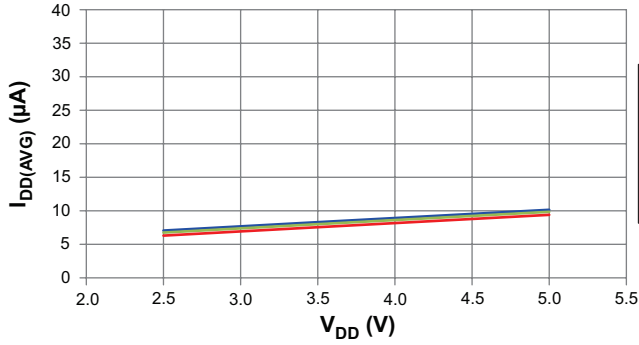

Average Supply Current vs. Supply Voltage

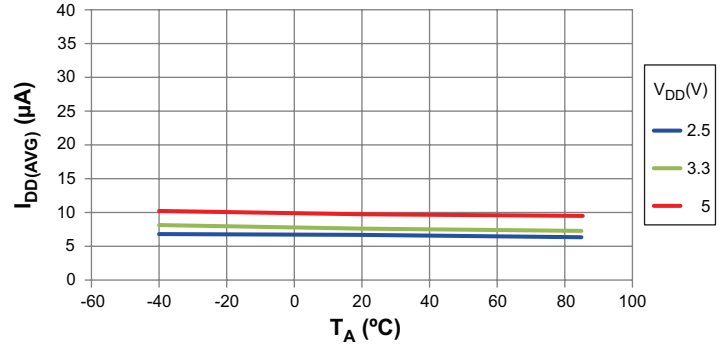

Average Supply Current vs. Ambient Temperature

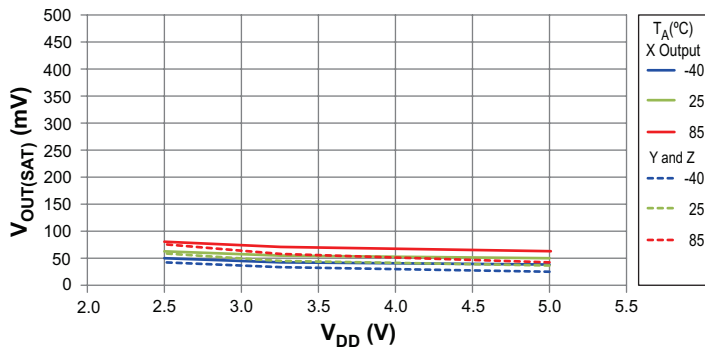

Average Low Output Voltage vs. Supply Voltage

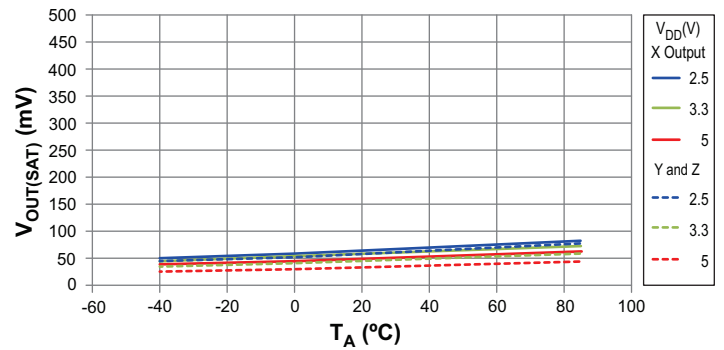

Average Low Output Voltage vs. Ambient Temperature
I_{OUT} = 20 mA

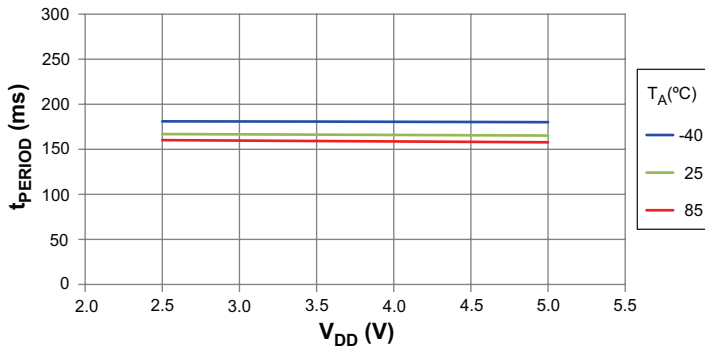

Average Period vs. Supply Voltage

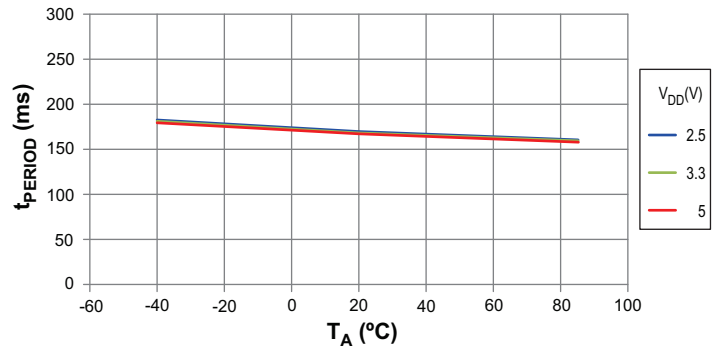

Average Period vs. Ambient Temperature

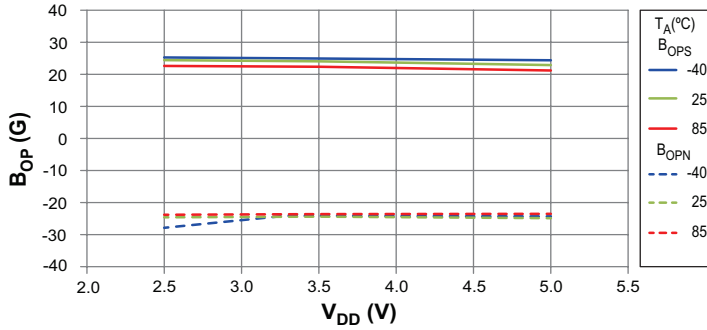

Average X-Axis Operate Point vs. Supply Voltage

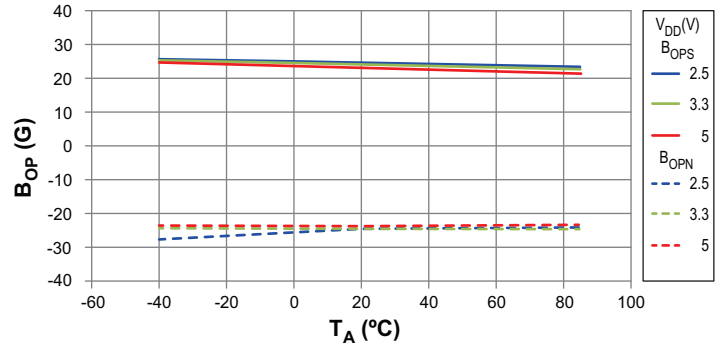

Average X-Axis Operate Point vs. Ambient Temperature

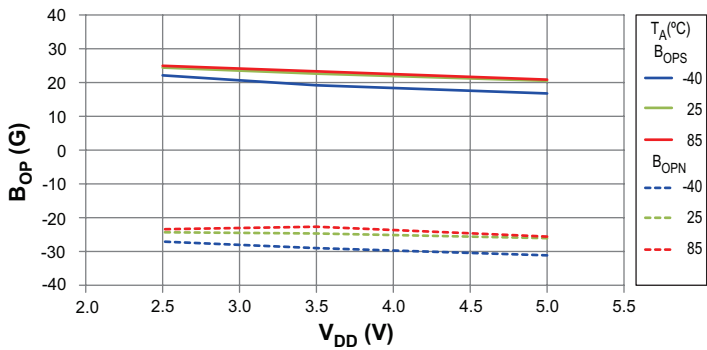

Average Y-Axis Operate Point vs. Supply Voltage

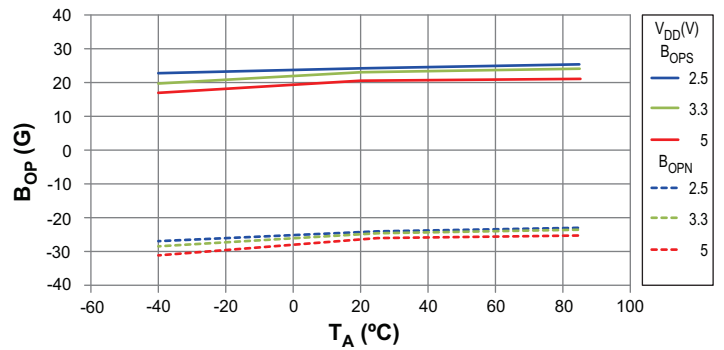

Average Y-Axis Operate Point vs. Ambient Temperature

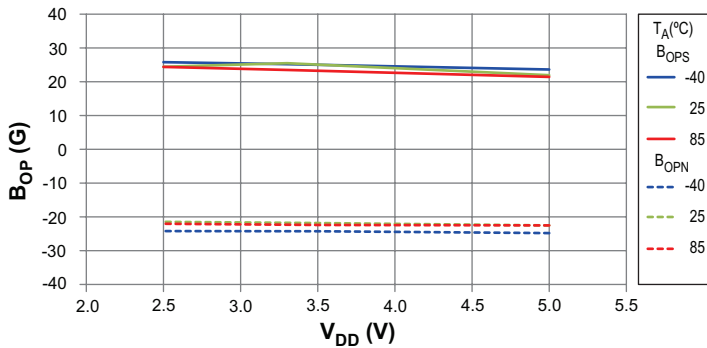

Average Z-Axis Operate Point vs. Supply Voltage

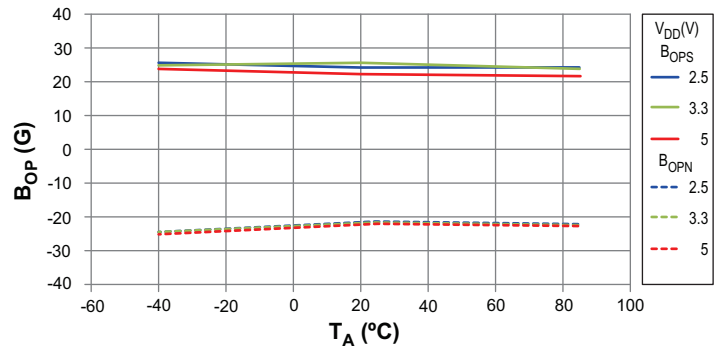

Average Z-Axis Operate Point vs. Ambient Temperature

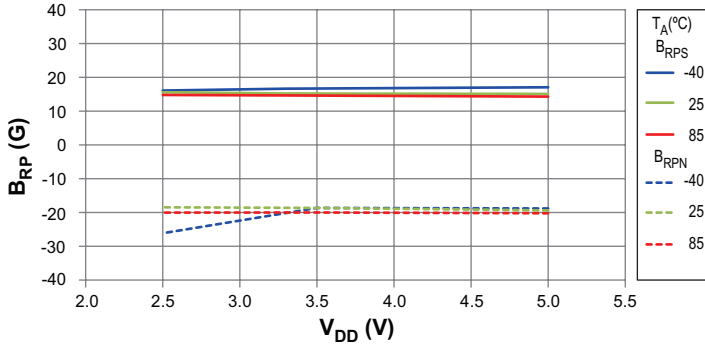

Average X-Axis Release Point vs. Supply Voltage

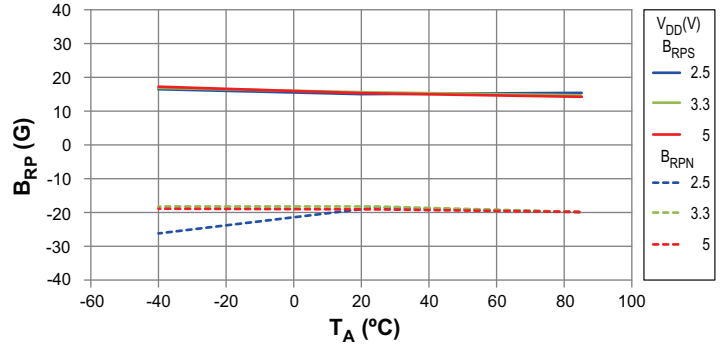

Average X-Axis Release Point vs. Ambient Temperature

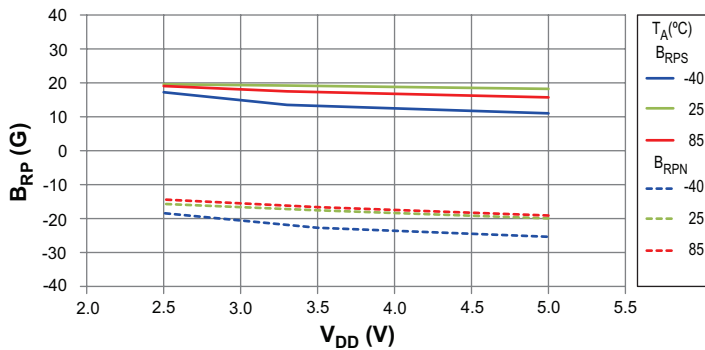

Average Y-Axis Release Point vs. Supply Voltage

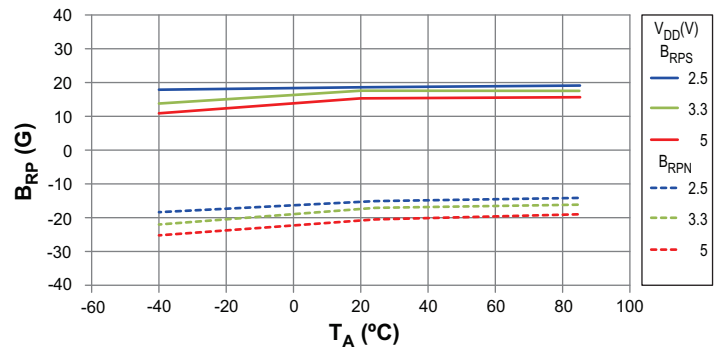

Average Y-Axis Release Point vs. Ambient Temperature

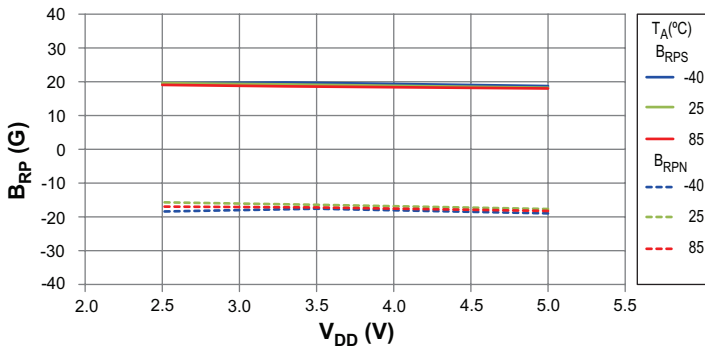

Average Z-Axis Release Point vs. Supply Voltage

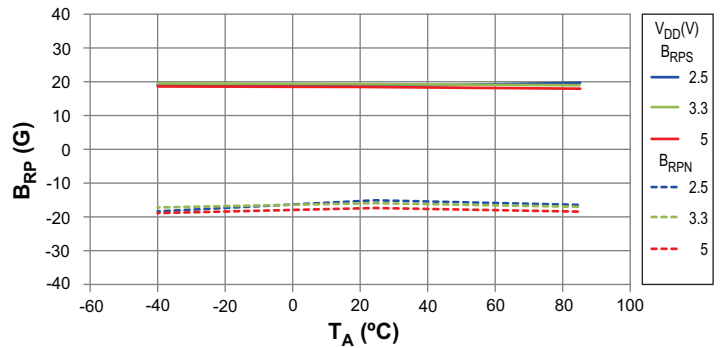

Average Z-Axis Release Point vs. Ambient Temperature

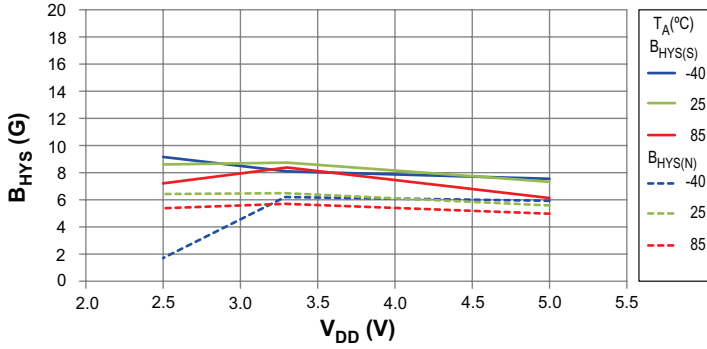

Average X-Axis Hysteresis vs. Supply Voltage

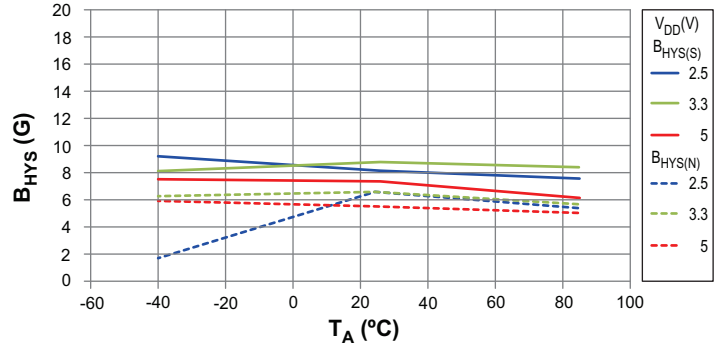

Average X-Axis Hysteresis vs. Ambient Temperature

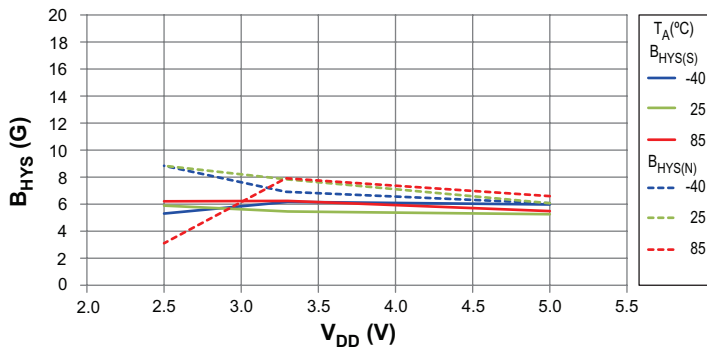

Average Y-Axis Hysteresis vs. Supply Voltage

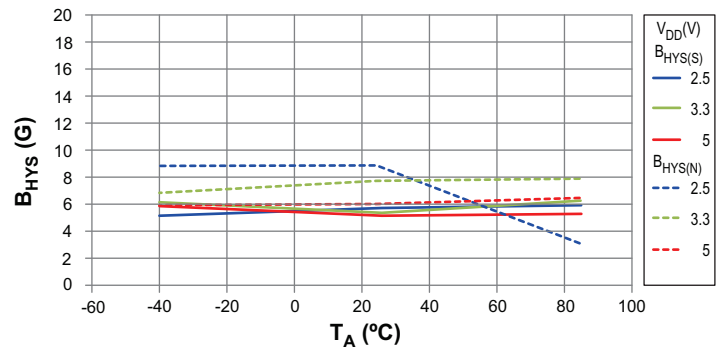

Average Y-Axis Hysteresis vs. Ambient Temperature

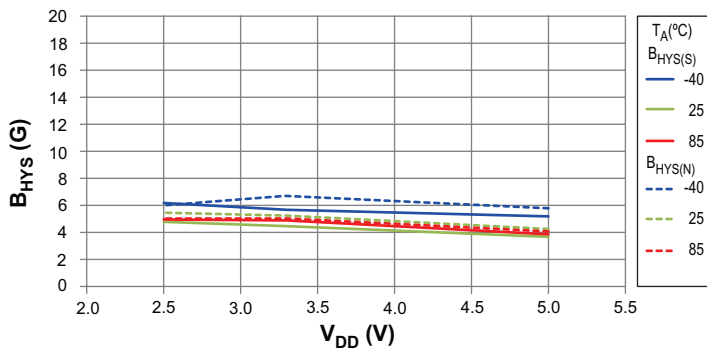

Average Z-Axis Hysteresis vs. Supply Voltage

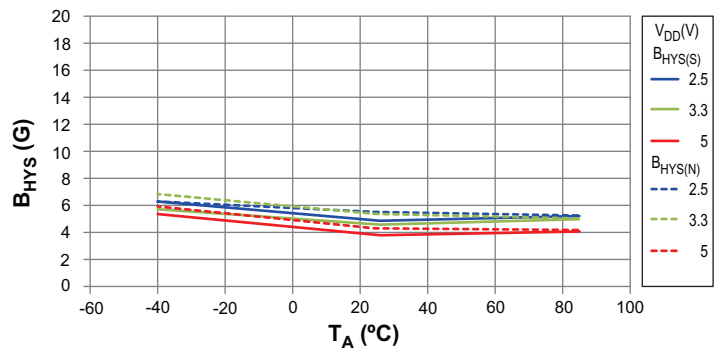

Average Z-Axis Hysteresis vs. Ambient Temperature

FUNCTIONAL DESCRIPTION

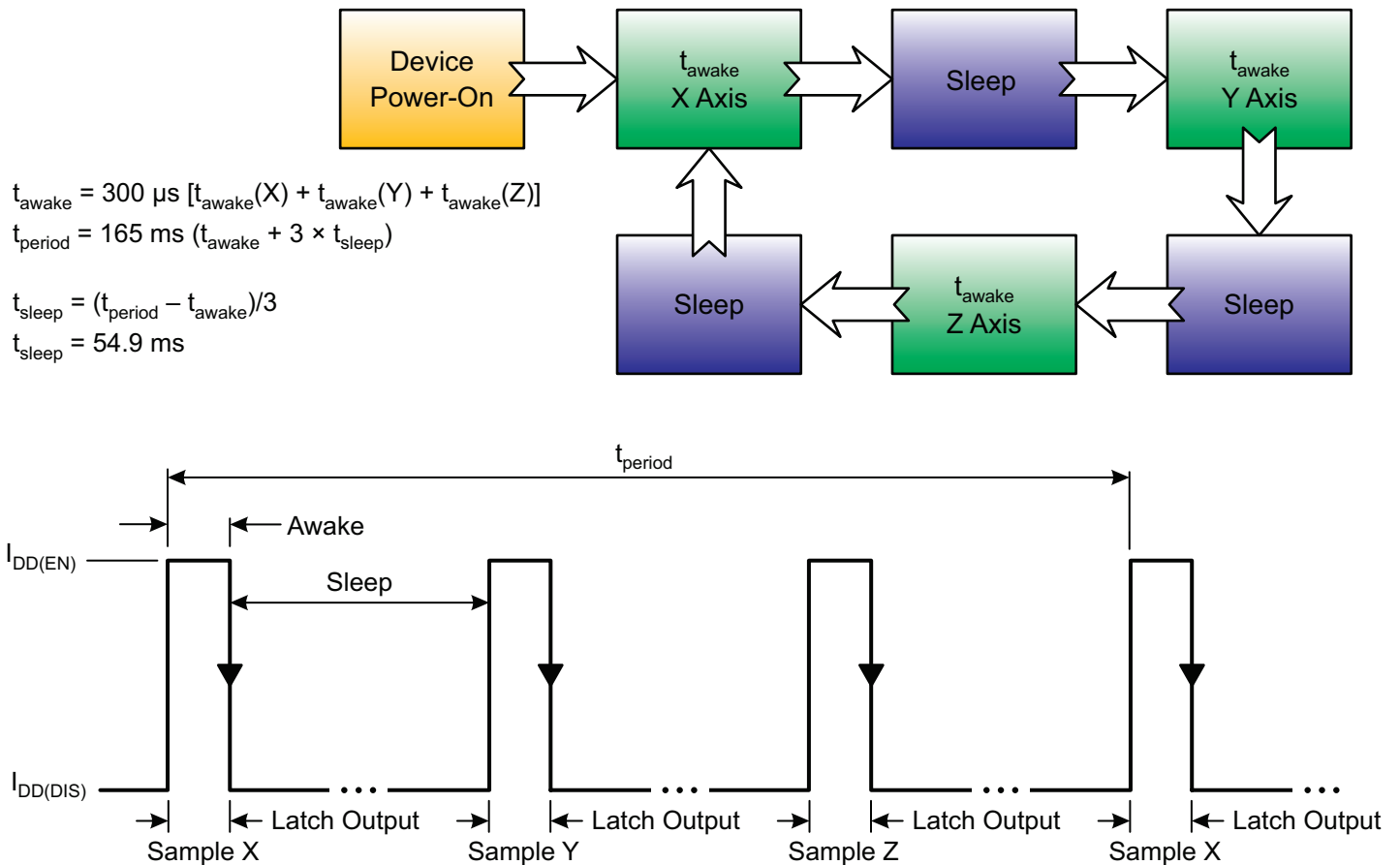

Figure 2: Device Sleep and Awake Mode Cycle

Low Average Power

To keep average power low, internal timing circuitry activates the sensor of each axis for 100 μs (followed by a low power sleep time, t_{sleep} , of 54.9 ms). This awake and sleep cycle occurs three times for each t_{period} , such that all three axes are sampled in t_{period} . The short “awake” time allows for stabilization prior to the sensor sampling and data latching at the end of each t_{awake} cycle. The outputs during each t_{sleep} cycle are latched in the last sampled state. The supply current is not affected by the output states.

Operation

For the single output option of the A1266, the output switches low (turns on) when a magnetic field perpendicular to one of the three Hall sensors, either the X, Y, or Z direction, exceeds the

operate point, B_{OPS} (or is less than B_{OPN}). The A1266 triple output option is configured with three separate outputs (X, Y, or Z), which switch low (turns on) when a magnetic field perpendicular to the corresponding Hall sensor (X, Y, or Z) exceeds the operate point, B_{OPS} (or is less than B_{OPN}). When the magnetic field is reduced below the release point, B_{RPS} (or increased above B_{RPN}), the device output switches high (turns off). The difference in the magnetic operate and release points is the hysteresis, B_{HYS} , of the device. This built-in hysteresis allows clean switching of the output even in the presence of external mechanical vibration and electrical noise.

After turn-on, the output voltage is V_{OUT} . Powering-on the device in the hysteresis region, between B_{OP} and B_{RP} , allows an indeterminate output state. The correct state is attained after the first excursion beyond B_{OP} or B_{RP} .

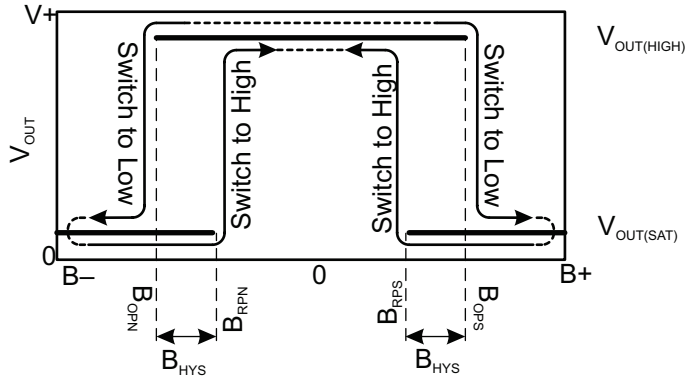

Figure 3: Switching Behavior of Omnipolar Switches

On the horizontal axis, the B+ direction indicates increasing south polarity magnetic field strength, and the B- direction indicates decreasing south polarity field strength (including the case of increasing north polarity)

Applications

It is strongly recommended that an external capacitor is connected (in close proximity to the Hall sensor IC) between the supply and ground of the device to reduce both external noise and noise generated by the chopper-stabilization technique. As shown in Figure 4, a 0.1 μF capacitor is typical.

Extensive applications information on magnets and Hall-effect sensors is available in:

- *Hall-Effect IC Applications Guide, AN27701,*
- *Hall-Effect Devices: Guidelines for Designing Subassemblies Using Hall-Effect Devices AN27703.1*
- *Soldering Methods for Allegro's Products – SMD and Through-Hole, AN26009*

All are provided on the Allegro website:

www.allegromicro.com

Typical Application Circuits

A1266ELHLT-SO3-T, A1266ELHLX-SO3-T, A1266ELHLT-SO-T, AND A1266ELHLX-SO-T

For sensors configured with the single output option, one pin reports the output state from any of the three Hall elements.

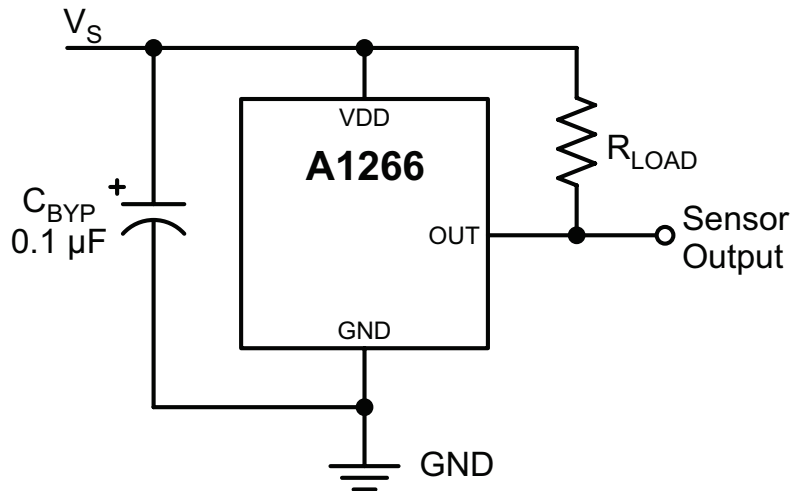

Figure 4: Typical Application Circuit for the Single Output Selection

A1266ELHLT-T AND A1266ELHLX-T

For sensors configured with the triple output option, the three separate open drain outputs report the output state from the corresponding Hall elements.

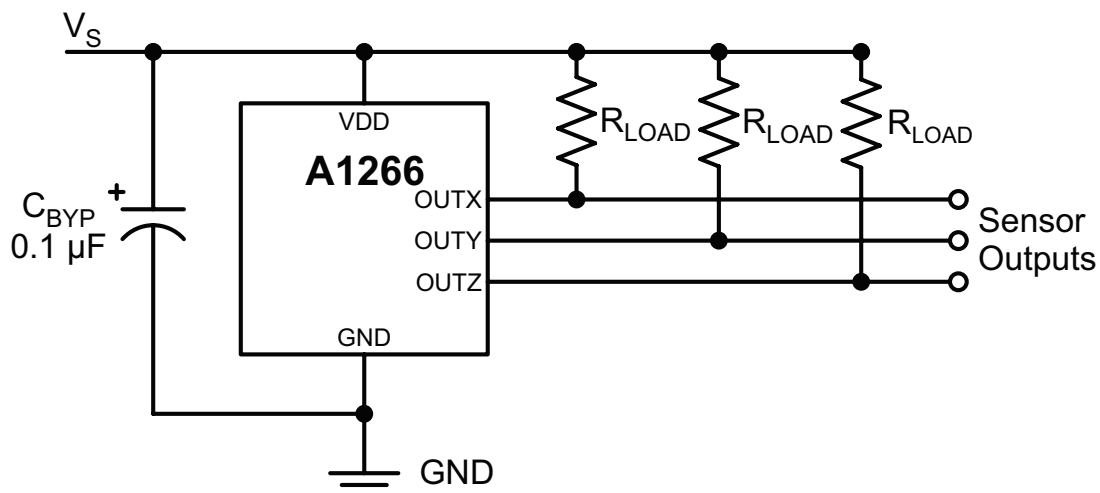

Figure 5: Typical Application Circuit for the Triple Output Selection

Chopper Stabilization

A limiting factor for switchpoint accuracy when using Hall-effect technology is the small signal voltage developed across the Hall plate. This voltage is proportionally small relative to the offset that can be produced at the output of the Hall sensor. This makes it difficult to process the signal and maintain an accurate, reliable output over the specified temperature and voltage range. Chopper stabilization is a proven approach used to minimize Hall offset.

The Allegro technique, dynamic quadrature offset cancellation, removes key sources of the output drift induced by temperature and package stress. This offset reduction technique is based on a signal modulation-demodulation process. Figure 6 illustrates how it is implemented.

The undesired offset signal is separated from the magnetically induced signal in the frequency domain through modulation. The subsequent demodulation acts as a modulation process for the offset, causing the magnetically induced signal to recover its orig-

inal spectrum at baseband while the DC offset becomes a high-frequency signal. Then, using a low-pass filter, the signal passes while the modulated DC offset is suppressed. Allegro's innovative chopper-stabilization technique uses a high-frequency clock. The high-frequency operation allows a greater sampling rate that produces higher accuracy, reduced jitter, and faster signal processing. Additionally, filtering is more effective and results in a lower noise analog signal at the sensor output. Devices such as the A1266 that use this approach have an extremely stable quiescent Hall output voltage, are immune to thermal stress, and have precise recoverability after temperature cycling. This technique is made possible through the use of a BiCMOS process, which allows the use of low-offset, low-noise amplifiers in combination with high-density logic and sample-and-hold circuits.

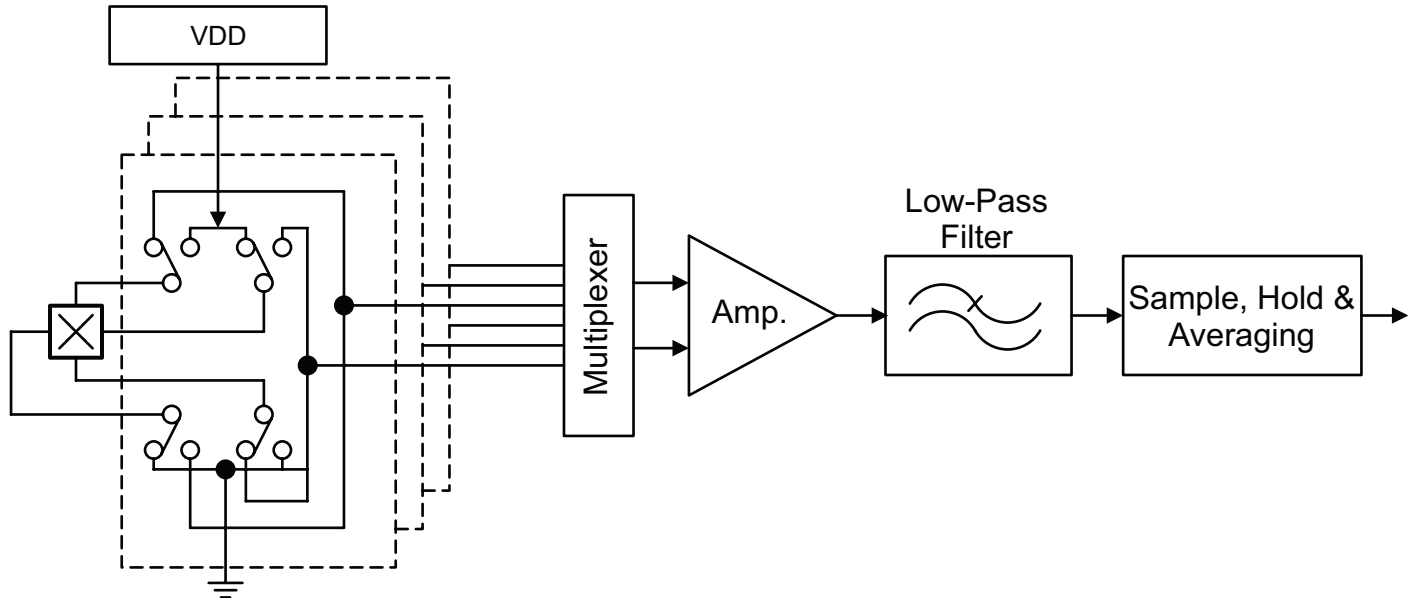

Figure 6: Model of Chopper-Stabilization Circuit (Dynamic Offset Cancellation)

PACKAGE OUTLINE DRAWINGS

For Reference Only – Not for Tooling Use

(Reference DWG-9069)

Dimensions in millimeters – NOT TO SCALE

Dimensions exclusive of mold flash, gate burrs, and dambar protrusions

Exact case and lead configuration at supplier discretion within limits shown

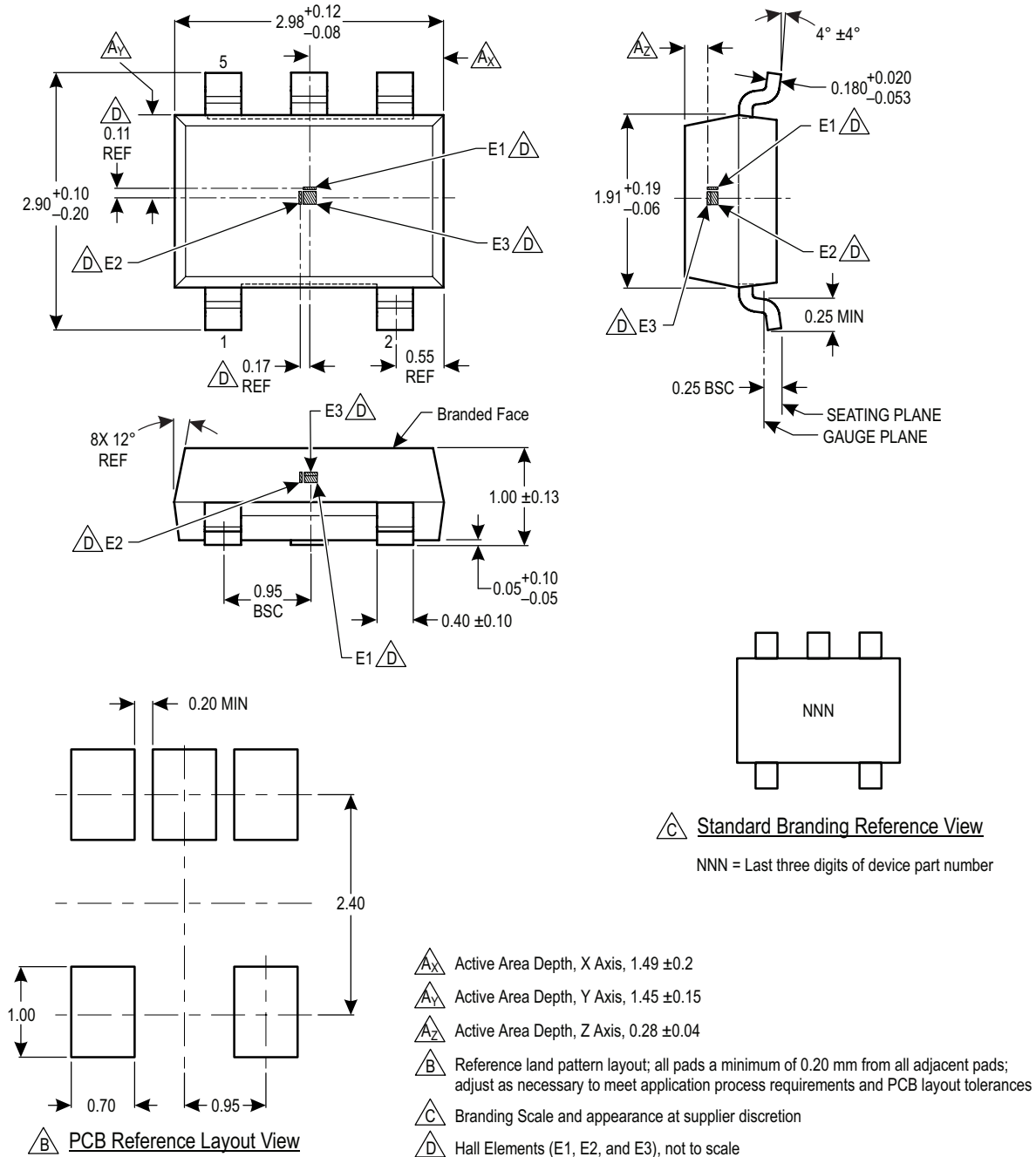

Figure 7: Package LH, 5-Pin SOT23-W

For Reference Only – Not for Tooling Use

(Reference DWG-2840)

Dimensions in millimeters – NOT TO SCALE

Dimensions exclusive of mold flash, gate burrs, and dambar protrusions
Exact case and lead configuration at supplier discretion within limits shown

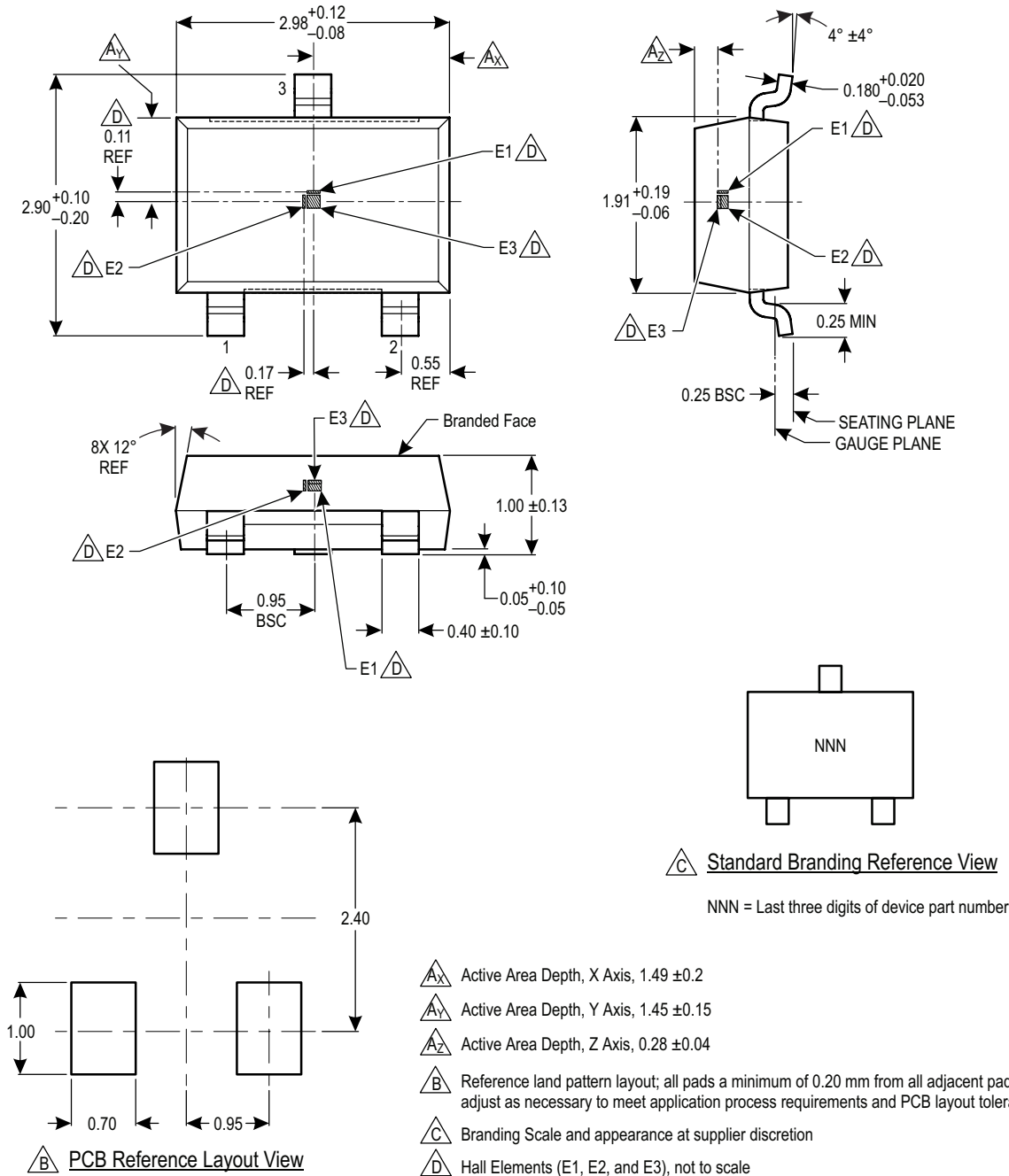

Figure 8: Package LH, 3-Pin SOT23-W

Revision History

Number	Date	Description
–	March 20, 2015	Initial Release
1	May 5, 2015	Revised $I_{DD(EN)}$ value and Figure 1
2	September 22, 2015	Added 3-pin SOT23-W package option and included explicit Active Area Depth for 3D sensor in both package drawings; revised $I_{DD(AVG)}$ values and Figure 1; revised pin labels in Functional Block Diagram
3	January 9, 2017	Updated product offering (pages 2, 3, 12)
4	April 10, 2017	Updated package drawings (pages 14-15)

Copyright ©2017, Allegro MicroSystems, LLC

Allegro MicroSystems, LLC reserves the right to make, from time to time, such departures from the detail specifications as may be required to permit improvements in the performance, reliability, or manufacturability of its products. Before placing an order, the user is cautioned to verify that the information being relied upon is current.

Allegro's products are not to be used in any devices or systems, including but not limited to life support devices or systems, in which a failure of Allegro's product can reasonably be expected to cause bodily harm.

The information included herein is believed to be accurate and reliable. However, Allegro MicroSystems, LLC assumes no responsibility for its use; nor for any infringement of patents or other rights of third parties which may result from its use.

For the latest version of this document, visit our website:

www.allegromicro.com

