

Differential Clock Buffer/Driver

Features

- Phase-locked loop (PLL) clock distribution for Double Data Rate Synchronous DRAM applications
- 1:5 differential outputs
- External feedback pins (FBINT, FBINC) are used to synchronize the outputs to the clock input
- SSCG: Spread Aware™ for electromagnetic interference (EMI) reduction
- 28-pin TSSOP package
- Conforms to JEDEC DDR specifications

Functional Description

The CY2SSTV855 is a high-performance, very-low-skew, very-low-jitter zero-delay buffer that distributes a differential clock input pair (SSTL_2) to four differential (SSTL_2) pairs of clock outputs and one differential pair of feedback clock outputs. In support of low power requirements, when power-down is HIGH, the outputs switch in phase and frequency with the input clock. When power-down is LOW, all outputs are disabled to a high-impedance state and the PLL is shut down.

The device supports a low-frequency power-down mode. When the input is < 20 MHz, the PLL is disabled and the outputs are put in the Hi-Z state. When the input frequency is > 20 MHz, the PLL and outputs are enabled.

When AVDD is tied to ground, the PLL is turned off and bypassed with the input reference clock gated to the outputs. The Cypress CY2SSTV855 is Spread Aware and supports tracking of Spread Spectrum clock inputs to reduce EMI

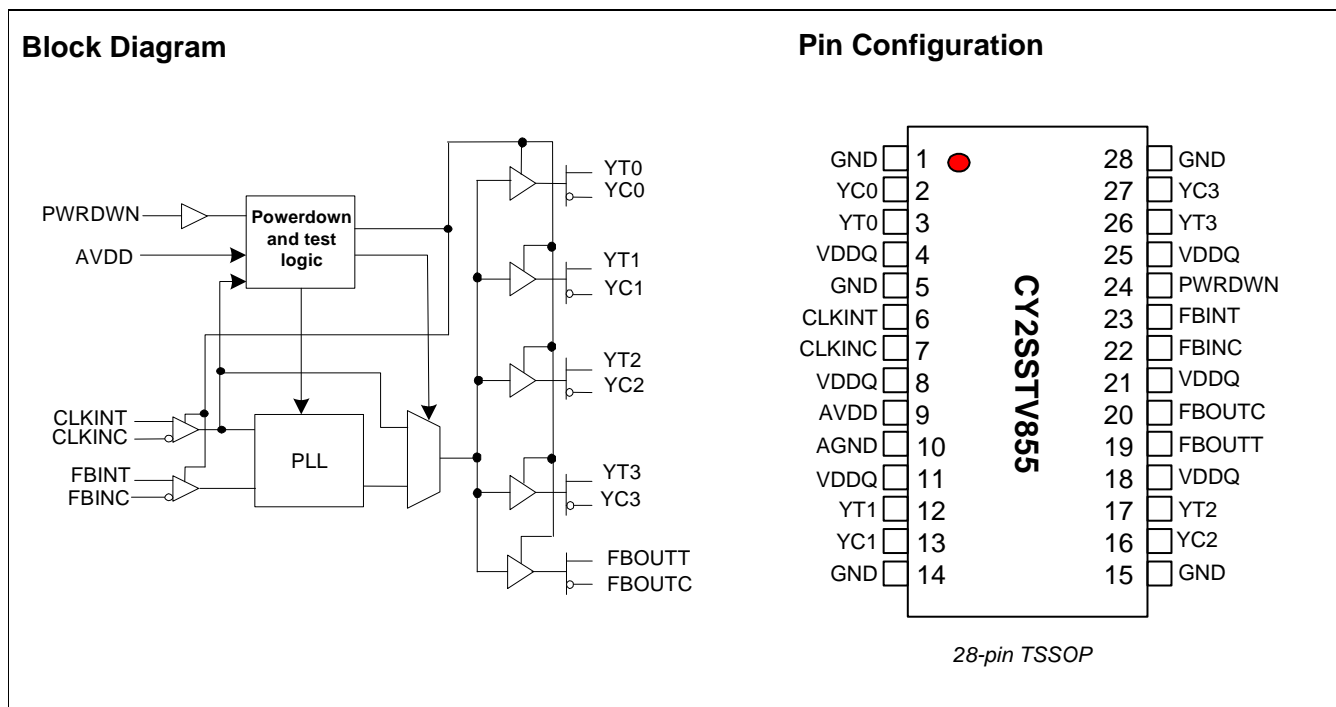

Pin Definition^[1, 2]

| Pin | Name | I/O | Description |
|-----------------|---------|-----|--|
| 6 | CLKINT | I | True Clock Input. Low Voltage Differential True Clock Input. |
| 7 | CLKINC | I | Complementary Clock Input. Low Voltage Differential Complementary Clock Input. |
| 22 | FBINC | I | Feedback Complementary Clock Input. Differential Input Connect to FBOUTC for accessing the PLL. |
| 23 | FBINT | I | Feedback True Clock Input. Differential Input Connect to FBOUTT for accessing the PLL. |
| 3,12,17,26 | YT(0:3) | O | True Clock Outputs. Differential Outputs. |
| 2,13,16,27 | YC(0:3) | O | Complementary Clock Outputs. Differential Outputs. |
| 19 | FBOUTT | O | Feedback True Clock Output. Differential Outputs. Connect to FBINT for normal operation. A bypass delay capacitor at this output will control Input Reference/Output Clocks phase relationships. |
| 20 | FBOUTC | O | Feedback Complementary Clock Output. Differential Outputs. Connect to FBINC for normal operation. A bypass delay capacitor at this output will control Input Reference/Output Clocks phase relationships. |
| 24 | PWRDWN | I | Control input to turn device in the power-down mode. |
| 4,8,11,18,21,25 | VDDQ | | 2.5V Power Supply for Output Clock Buffers. 2.5V Nominal. |
| 9 | AVDD | | 2.5V Power Supply for PLL. 2.5V Nominal. |
| 1,5,14,15,28 | GND | | Ground |
| 10 | AGND | | Analog Ground. 2.5V Analog Ground. |

Zero-delay Buffer

When used as a zero-delay buffer the CY2SSTV855 will likely be in a nested clock tree application. For these applications the CY2SSTV855 offers a differential clock input pair as a PLL reference. The CY2SSTV855 then can lock onto the reference and translate with near zero delay to low-skew outputs. For normal operation, the external feedback differential input, FBINT/C, is connected to the feedback output, FBOUTT/C. By

connecting the feedback output to the feedback input the propagation delay through the device is eliminated. The PLL works to align the output edge with the input reference edge thus producing a near zero delay. The reference frequency affects the static phase offset of the PLL and thus the relative delay between the inputs and outputs.

When AVDD is strapped LOW, the PLL is turned off and bypassed for test purposes.

Function Table

| Inputs | | | | Outputs | | | | PLL |
|--------|--------|----------|----------|---------|---------|--------|--------|--------------|
| AVDD | PWRDWN | CLKINT | CLKINC | YT(0:3) | YC(0:3) | FBOUTT | FBOUTC | |
| GND | H | L | H | L | H | L | H | BYPASSED/OFF |
| GND | H | H | L | H | L | H | L | BYPASSED/OFF |
| 2.5V | H | L | H | L | H | L | H | On |
| 2.5V | H | H | L | H | L | H | L | On |
| 2.5V | X | < 20 MHz | < 20 MHz | Hi-Z | Hi-Z | Hi-Z | Hi-Z | Off |

Notes:

1. PU = internal pull-up.
2. A bypass capacitor (0.1µF) should be placed as close as possible to each positive power pin (< 0.2"). If these bypass capacitors are not close to the pins their high frequency filtering characteristic will be cancelled by the lead inductance of the traces.



Differential Parameter Measurement Information

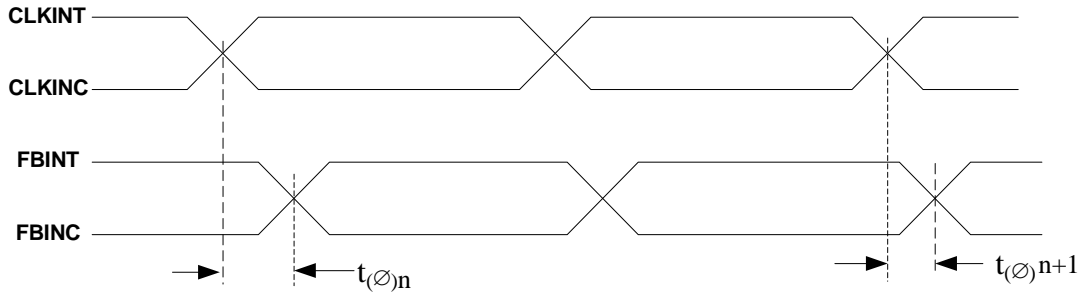

$$t_{(\phi)n} = \frac{\sum_{1}^{n=N} t_{(\phi)n}}{N} \quad N(\text{is large number of samples})$$

Figure 1. Static Phase Offset

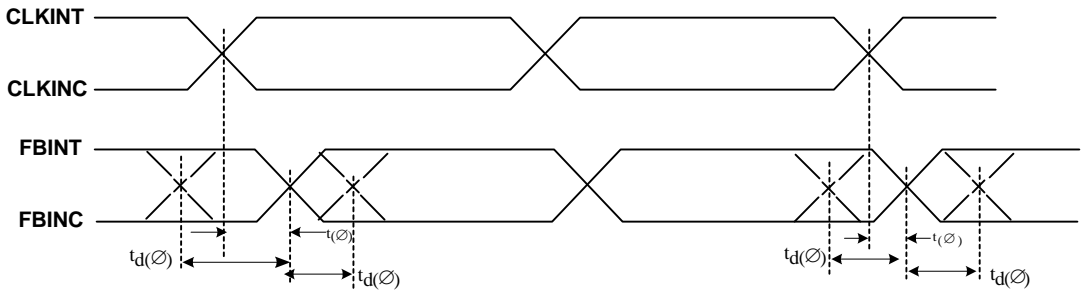

Figure 2. Dynamic Phase Offset

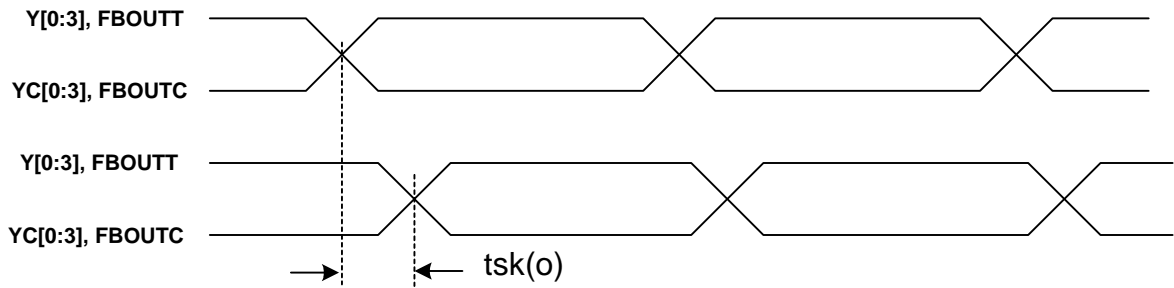

Figure 3. Output Skew

Differential Parameter Measurement Information (continued)

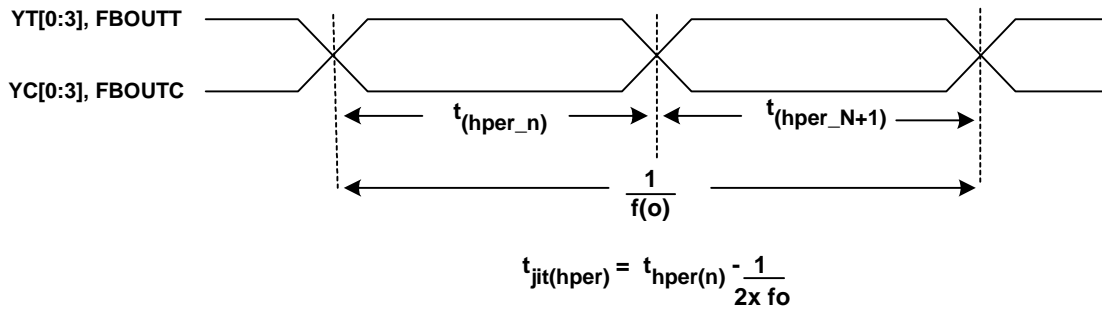

Figure 4. Half-period Jitter

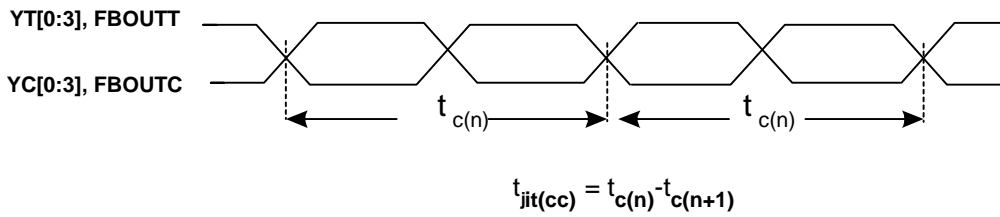

Figure 5. Cycle-to-cycle Jitter

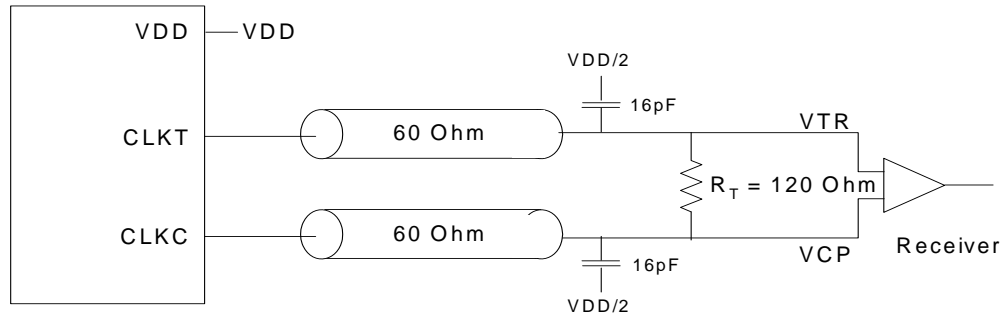

Figure 6. Differential Signal Using Direct Termination Resistor

Absolute Maximum Conditions^[3]

Input Voltage Relative to V_{SS} : $V_{SS} - 0.3V$
 Input Voltage Relative to V_{DDQ} or AV_{DD} : $V_{DD} + 0.3V$
 Storage Temperature: $-65^{\circ}C$ to $+150^{\circ}C$
 Operating Temperature: $-40^{\circ}C$ to $+85^{\circ}C$
 Maximum Power Supply: $3.5V$

This device contains circuitry to protect the inputs against damage due to high static voltages or electric field; however, precautions should be taken to avoid application of any voltage higher than the maximum rated voltages to this circuit. For proper operation, V_{in} and V_{out} should be constrained to the range:

$$V_{SS} < (V_{in} \text{ or } V_{out}) < V_{DD}$$

Unused inputs must always be tied to an appropriate logic voltage level (either V_{SS} or V_{DD}).

DC Electrical Specifications ($AV_{DD} = V_{DDQ} = 2.5V \pm 5\%$, $T_A = -40^{\circ}C$ to $+85^{\circ}C$)^[4]

| Parameter | Description | Conditions | Min. | Typ. | Max. | Unit |
|-----------|--|---|---------------------|-------------|---------------------|---------|
| V_{ID} | Differential Input Voltage ^[5] | CLKINT, FBINT | 0.36 | | $V_{DDQ} + 0.6$ | V |
| V_{IX} | Differential Input Crossing Voltage ^[6] | CLKTIN, FBINT | $(V_{DDQ}/2) - 0.2$ | $V_{DDQ}/2$ | $(V_{DDQ}/2) + 0.2$ | V |
| I_{IN} | Input Current | $V_{IN} = 0V$ or $V_{IN} = V_{DDQ}$, CLKINT, FBINT | -10 | - | 10 | μA |
| I_{OL} | Output Low Current | $V_{DDQ} = 2.375V$, $V_{OUT} = 1.2V$ | 26 | 35 | - | mA |
| I_{OH} | Output High Current | $V_{DDQ} = 2.375V$, $V_{OUT} = 1V$ | -18 | -32 | - | mA |
| V_{OL} | Output Low Voltage | $V_{DDQ} = 2.375V$, $I_{OL} = 12 \text{ mA}$ | | - | 0.6 | V |
| V_{OH} | Output High Voltage | $V_{DDQ} = 2.375V$, $I_{OH} = -12 \text{ mA}$ | 1.7 | - | - | V |
| V_{OUT} | Output Voltage Swing ^[7] | | 1.1 | - | $V_{DDQ} - 0.4$ | V |
| V_{OC} | Output Crossing Voltage ^[8] | | $(V_{DDQ}/2) - 0.2$ | $V_{DDQ}/2$ | $(V_{DDQ}/2) + 0.2$ | V |
| I_{OZ} | High-Impedance Output Current | $V_O = GND$ or $V_O = V_{DDQ}$ | -10 | | 10 | μA |
| I_{DDQ} | Dynamic Supply Current ^[9] | $V_{DDQ} = 170 \text{ MHz}$ | - | 235 | 300 | mA |
| I_{DD} | PLL Supply Current | AV_{DD} only | - | 9 | 12 | mA |
| C_{in} | Input Pin Capacitance | | - | 4 | - | pF |

AC Electrical Specifications ($AV_{DD} = V_{DDQ} = 2.5V \pm 5\%$, $T_A = -40^{\circ}C$ to $+85^{\circ}C$)^[10, 11]

| Parameter | Description | Conditions | Min. | Typ. | Max. | Unit |
|-----------------------|---|---------------------------|------|------|------|---------|
| f_{CLK} | Operating Clock Frequency | $AV_{DD} = 2.5V \pm 0.2V$ | 60 | | 170 | MHz |
| t_{DC} | Input Clock Duty Cycle ^[12] | | 40 | | 60 | % |
| t_{LOCK} | Maximum PLL lock Time | | | | 100 | μs |
| $t_{SL(O)}$ | Output Clocks Slew Rate | 20% to 80% of VOD | 1 | | 2 | V/ns |
| t_{PZL} , t_{PZH} | Output Enable Time (all outputs) ^[13] | | | 30 | | ns |
| t_{PLZ} , t_{PHZ} | Output Disable Time (all outputs) ^[13] | | | 10 | | ns |
| t_{CCJ} | Cycle to Cycle Jitter | $f > 66 \text{ MHz}$ | -100 | | 100 | ps |
| $t_{JITT(H-PER)}$ | Half-period jitter | $f > 66 \text{ MHz}$ | -100 | | 100 | ps |

Notes:

- Multiple Supplies:** The voltage on any input or I/O pin cannot exceed the power pin during power-up. Power supply sequencing is NOT required.
- Unused inputs must be held HIGH or LOW to prevent them from floating.
- Differential input signal voltage specifies the differential voltage $|V_{TR} - V_{CP}|$ required for switching, where V_{TR} is the true input level and V_{CP} is the complementary input level.
- Differential cross-point input voltage is expected to track V_{DDQ} and is the voltage at which the differential signals must be crossing.
- For load conditions see *Figure 6*.
- The value of V_{OC} is expected to be $|V_{TR} + V_{CP}|/2$. In case of each clock directly terminated by a 120Ω resistor. See *Figure 6*.
- All outputs switching loaded with 16 pF in 60Ω environment. See *Figure 6*.
- Parameters are guaranteed by design and characterization. Not 100% tested in production.
- PLL is capable of meeting the specified parameters while supporting SSC synthesizers with modulation frequency between 30 kHz and 33.3 kHz with a downspread of -0.5%
- While the pulse skew is almost constant over frequency, the duty cycle error increases at higher frequencies. This is due to the formula: duty cycle = t_{WH}/t_C , where the cycle time (t_C) decreases as the frequency goes up.
- Refers to transition of non-inverting output.
- All differential input and output terminals are terminated with $120\Omega/16 \text{ pF}$ as shown in *Figure 6*.

AC Electrical Specifications ($V_{DD} = V_{DDQ} = 2.5V \pm 5\%$, $T_A = -40^\circ C$ to $+85^\circ C$)^[10, 11] (continued)

| Parameter | Description | Conditions | Min. | Typ. | Max. | Unit |
|--------------------|--|--------------|------|------|------|------|
| t_{PLH} | Low-to-High Propagation Delay, CLKINT to YT[0:3] | | 1.5 | 3.5 | 6 | ns |
| t_{PHL} | High-to-Low Propagation Delay, CLKINT to YT[0:3] | | 1.5 | 3.5 | 6 | ns |
| $t_{SK(0)}$ | Any Output to Any Output Skew ^[14] | | – | – | 100 | ps |
| $t_{(\emptyset)}$ | Static Phase Offset ^[14] | | –450 | – | 450 | ps |
| $t_{D(\emptyset)}$ | Dynamic Phase Offset | $f > 66$ MHz | –350 | – | 350 | ps |

Ordering Information

| Part Number | Package Type | Product Flow |
|------------------|------------------------------|--------------------------|
| CY2SSTV855ZC | 28-pin TSSOP | Commercial, 0° to 70°C |
| CY2SSTV855ZCT | 28-pin TSSOP – Tape and Reel | Commercial, 0° to 70°C |
| CY2SSTV855ZI | 28-pin TSSOP | Industrial, –40° to 85°C |
| CY2SSTV855ZIT | 28-pin TSSOP – Tape and Reel | Industrial, –40° to 85°C |
| Lead Free | | |
| CY2SSTV855ZXC | 28-pin TSSOP | Commercial, 0° to 70°C |
| CY2SSTV855ZXT | 28-pin TSSOP – Tape and Reel | Commercial, 0° to 70°C |
| CY2SSTV855ZXI | 28-pin TSSOP | Industrial, –40° to 85°C |
| CY2SSTV855ZXIT | 28-pin TSSOP – Tape and Reel | Industrial, –40° to 85°C |

Package Drawing and Dimensions

28-Lead Thin Shrunken Small Outline Package (4.40-mm Body) Z28.173

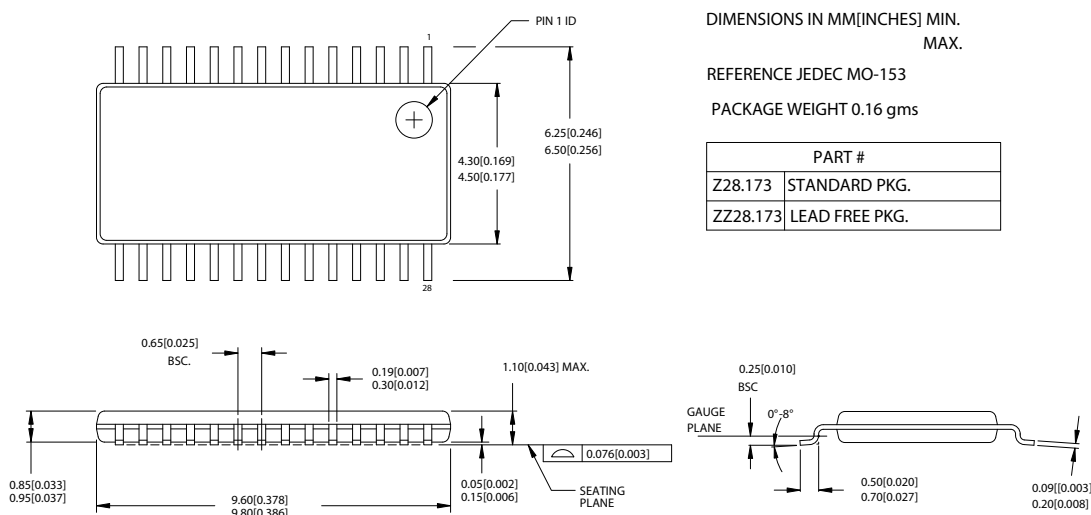

The information in this document is believed to be accurate in all respects at the time of publication but is subject to change without notice. Silicon Laboratories assumes no responsibility for errors and omissions, and disclaims responsibility for any consequences resulting from the use of information included herein. Additionally, Silicon Laboratories assumes no responsibility for the functioning of undescribed features or parameters. Silicon Laboratories reserves the right to make changes without further notice. Silicon Laboratories makes no warranty, representation or guarantee regarding the suitability of its products for any particular purpose, nor does Silicon Laboratories assume any liability arising out of the application or use of any product or circuit, and specifically disclaims any and all liability, including without limitation consequential or incidental damages. Silicon Laboratories products are not designed, intended, or authorized for use in applications intended to support or sustain life, or for any other application in which the failure of the Silicon Laboratories product could create a situation where personal injury or death may occur. Should Buyer purchase or use Silicon Laboratories products for any such unintended or unauthorized application, Buyer shall indemnify and hold Silicon Laboratories harmless against all claims and damages.