

EAHP2024WB8

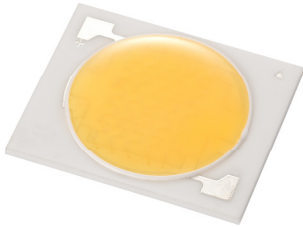

Introduction

Everlight's EAHP2024WB8 Series is a ceramic substrate based LED achieving high efficiency while maintaining high CRI at Energy Star / ANSI color temperature ranges.

Features

- ◆ LM-80 Certified
- ◆ High Power COB & High CRI LED
- ◆ Multi-Chip Solution
- ◆ Dimension: 20 mm x 24 mm x 1.6 mm
- ◆ Main Parameters: Luminous Flux, Forward Voltage, Chromaticity and Color Rendering Index
- ◆ ESD Protection
- ◆ RoHS compliant
- ◆ Energy Star / ANSI Compliant Binning Structure
- ◆ Typical Viewing Angle: 120°

Applications

- ◆ Replacement Bulb
- ◆ Indoor General Lighting
- ◆ Recessed Can Lighting

Absolute Maximum Ratings

| Parameter | Symbol | Ratings | Unit |
|------------------------------|-------------|--------------------|------|
| Max. DC Forward Current (mA) | I_F | 550 _[1] | mA |
| Max. Peak Pulse Current (mA) | I_{Pulse} | 800 _[2] | mA |
| Power Dissipation | P_d | 16.5 | W |
| Thermal Resistance | R_{th} | 2.4 | °C/W |
| Max. Junction Temperature | T_J | 115 | °C |
| Operating Temperature | T_{Opr} | -40 ~ +85 | °C |
| Storage Temperature | T_{Stg} | -40 ~ +85 | °C |

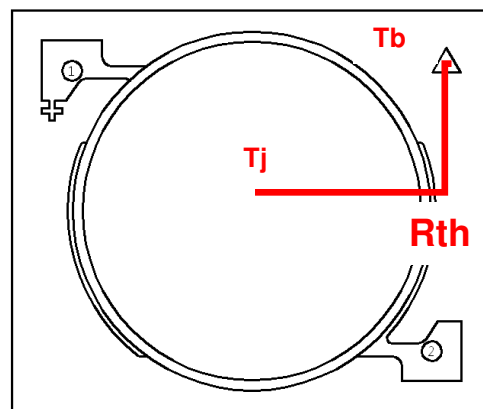

Measuring point for
case temperature

Notes:

1. For optimal performance, Everlight recommends 500mA operation.
2. $t_p \leq 100ms$, Duty cycle = 25%
3. The EAHP2024WB8 LEDs are not designed for reverse bias use.

PN of the EAHP2024WB8 : White LEDs

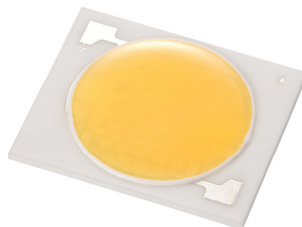

| Color | Order Code of EAHP2024WB8 | Minimum Luminous Flux (lm) | Typical Luminous Flux (lm) | CCT (K) | Forward Voltage (V) | Forward Current (mA) | CRI (min.) |
|-----------------|---------------------------|----------------------------|----------------------------|-------------|---------------------|----------------------|------------|
| Cool White 6500 | EAHP2024WB8 | 1725 | 1850 | 65K-1~65K-4 | 27.0~33.0 | 500 | 80 |

Notes:

1. CRI measurement tolerance: ± 2 .
2. Luminous flux measurement tolerance: $\pm 10\%$.
3. The data of luminous flux measured at thermal pad=25°C
4. Typical luminous flux or light output performance is operated within the condition guided by this datasheet.

Product Binning

Luminous Flux Bins

| Group | Bin | Minimum Photometric Flux (lm) | Maximum Photometric Flux (lm) |
|-------|-----|-------------------------------|-------------------------------|
| K | 1 | 225 | 250 |
| | 2 | 250 | 275 |
| | 3 | 275 | 300 |
| | 4 | 300 | 325 |
| | 5 | 325 | 350 |
| | 6 | 350 | 375 |
| | 7 | 375 | 400 |
| | 8 | 400 | 425 |
| | 9 | 425 | 450 |
| N | 1 | 450 | 475 |
| | 2 | 475 | 500 |
| | 3 | 500 | 550 |
| | 4 | 550 | 600 |
| | 5 | 600 | 650 |
| | 6 | 650 | 700 |
| | 7 | 700 | 750 |
| | 8 | 750 | 800 |
| | 9 | 800 | 900 |

| Group | Bin | Minimum Photometric Flux (lm) | Maximum Photometric Flux (lm) |
|-------|-----|-------------------------------|-------------------------------|
| P | 1 | 900 | 1000 |
| | 2 | 1000 | 1100 |
| | 3 | 1100 | 1200 |
| | 4 | 1200 | 1350 |
| | 5 | 1350 | 1500 |
| | 6 | 1500 | 1650 |
| | 7 | 1650 | 1800 |
| | 8 | 1800 | 2000 |
| | 9 | 2000 | 2200 |
| S | 1 | 2200 | 2400 |
| | 2 | 2400 | 2650 |
| | 3 | 2650 | 2900 |
| | 4 | 2900 | 3200 |
| | 5 | 3200 | 3500 |
| | 6 | 3500 | 3850 |
| | 7 | 3850 | 4200 |
| | 8 | 4200 | 4600 |
| | | | |

White Bin Structure

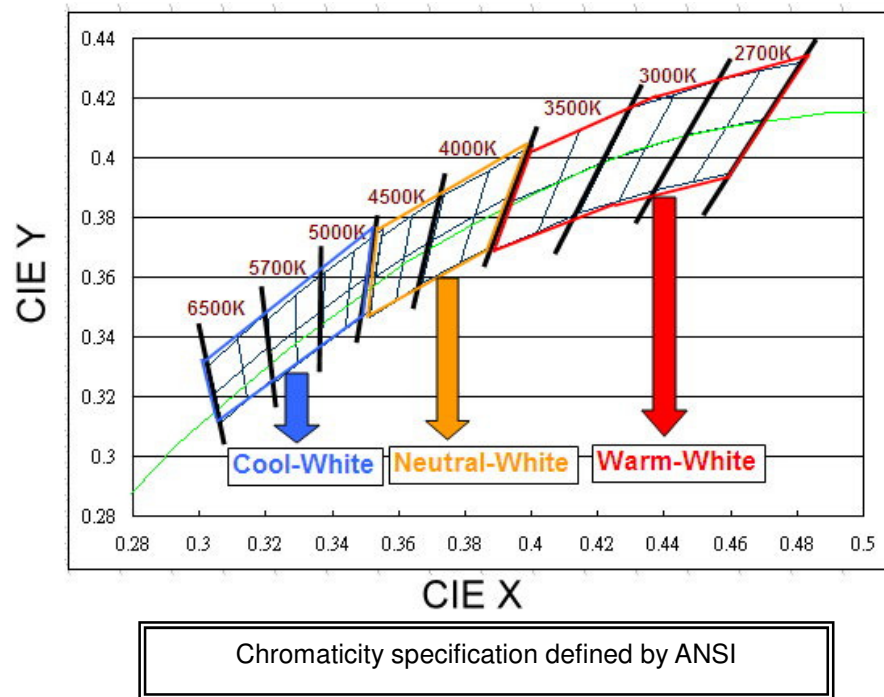

Notes:

1. The CCT range of Cool-White varies from 4745K to 7050K.
2. The CCT range of Neutral-White varies from 3710K to 4745K.
3. The CCT range of Warm-White varies from 2580K to 3710K
4. Color coordinates measurement allowance : ± 0.01
5. Color bins are defined at $I_f=500\text{mA}$ operation

Warm White Bin Structure

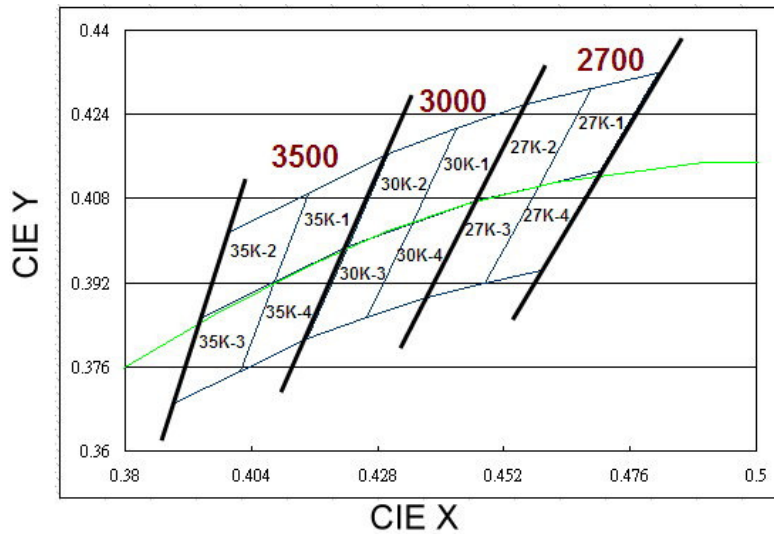

Warm White Bin Coordinates

2700K

| Bin | CIE X | CIE Y |
|-----------------------------|-------|-------|
| 27K-1 | 0.469 | 0.429 |
| | 0.459 | 0.410 |
| | 0.470 | 0.413 |
| | 0.481 | 0.432 |
| Reference Range: 2580~2700K | | |

| Bin | CIE X | CIE Y |
|-----------------------------|-------|-------|
| 27K-2 | 0.456 | 0.426 |
| | 0.447 | 0.408 |
| | 0.459 | 0.410 |
| | 0.469 | 0.429 |
| Reference Range: 2700~2870K | | |

| Bin | CIE X | CIE Y |
|-----------------------------|-------|-------|
| 27K-4 | 0.459 | 0.410 |
| | 0.448 | 0.392 |
| | 0.459 | 0.394 |
| | 0.470 | 0.413 |
| Reference Range: 2580~2700K | | |

| Bin | CIE X | CIE Y |
|-----------------------------|-------|-------|
| 27K-3 | 0.447 | 0.408 |
| | 0.437 | 0.389 |
| | 0.448 | 0.392 |
| | 0.459 | 0.410 |
| Reference Range: 2700~2870K | | |

3000K

| Bin | CIE X | CIE Y |
|-----------------------------|-------|-------|
| 30K-1 | 0.456 | 0.426 |
| | 0.443 | 0.421 |
| | 0.435 | 0.403 |
| | 0.447 | 0.408 |
| Reference Range: 2870~3000K | | |

| Bin | CIE X | CIE Y |
|-----------------------------|-------|-------|
| 30K-2 | 0.443 | 0.421 |
| | 0.430 | 0.417 |
| | 0.422 | 0.399 |
| | 0.435 | 0.403 |
| Reference Range: 3000~3170K | | |

| Bin | CIE X | CIE Y |
|-----------------------------|-------|-------|
| 30K-4 | 0.447 | 0.408 |
| | 0.435 | 0.403 |
| | 0.426 | 0.385 |
| | 0.437 | 0.389 |
| Reference Range: 2870~3000K | | |

| Bin | CIE X | CIE Y |
|-----------------------------|-------|-------|
| 30K-3 | 0.435 | 0.403 |
| | 0.422 | 0.399 |
| | 0.415 | 0.381 |
| | 0.426 | 0.385 |
| Reference Range: 3000~3170K | | |

3500K

| Bin | CIE X | CIE Y |
|-----------------------------|-------|-------|
| 35K-1 | 0.415 | 0.409 |
| | 0.408 | 0.392 |
| | 0.422 | 0.399 |
| | 0.430 | 0.417 |
| Reference Range: 3220~3500K | | |

| Bin | CIE X | CIE Y |
|-----------------------------|-------|-------|
| 35K-2 | 0.400 | 0.402 |
| | 0.394 | 0.385 |
| | 0.408 | 0.392 |
| | 0.415 | 0.409 |
| Reference Range: 3500~3710K | | |

| Bin | CIE X | CIE Y |
|-----------------------------|-------|-------|
| 35K-4 | 0.408 | 0.392 |
| | 0.402 | 0.375 |
| | 0.415 | 0.381 |
| | 0.422 | 0.399 |
| Reference Range: 3220~3500K | | |

| Bin | CIE X | CIE Y |
|-----------------------------|-------|-------|
| 35K-3 | 0.394 | 0.385 |
| | 0.389 | 0.369 |
| | 0.402 | 0.375 |
| | 0.408 | 0.392 |
| Reference Range: 3500~3710K | | |

Neutral-White Bin Structure

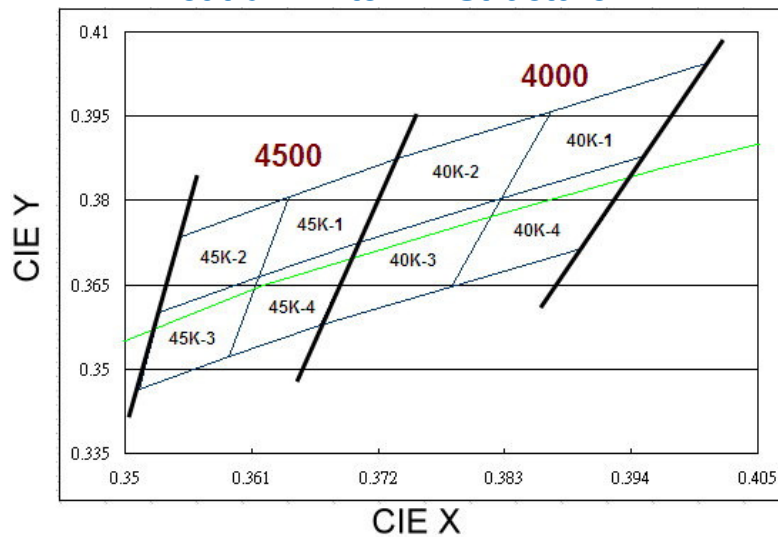

Neutral-White Bin Coordinates

4000K

| Bin | CIE X | CIE Y |
|-----------------------------|-------|-------|
| 40K-1 | 0.387 | 0.396 |
| | 0.383 | 0.380 |
| | 0.395 | 0.388 |
| | 0.401 | 0.404 |
| Reference Range: 3710~4000K | | |

| Bin | CIE X | CIE Y |
|-----------------------------|-------|-------|
| 40K-2 | 0.374 | 0.387 |
| | 0.370 | 0.373 |
| | 0.383 | 0.380 |
| | 0.387 | 0.396 |
| Reference Range: 4000~4260K | | |

| Bin | CIE X | CIE Y |
|-----------------------------|-------|-------|
| 40K-4 | 0.383 | 0.380 |
| | 0.378 | 0.365 |
| | 0.390 | 0.372 |
| | 0.395 | 0.388 |
| Reference Range: 3710~4000K | | |

| Bin | CIE X | CIE Y |
|-----------------------------|-------|-------|
| 40K-3 | 0.370 | 0.373 |
| | 0.367 | 0.358 |
| | 0.378 | 0.365 |
| | 0.383 | 0.380 |
| Reference Range: 4000~4260K | | |

4500K

| Bin | CIE X | CIE Y |
|-----------------------------|-------|-------|
| 45K-1 | 0.364 | 0.381 |
| | 0.362 | 0.366 |
| | 0.370 | 0.373 |
| | 0.374 | 0.387 |
| Reference Range: 4260~4500K | | |

| Bin | CIE X | CIE Y |
|-----------------------------|-------|-------|
| 45K-2 | 0.355 | 0.374 |
| | 0.353 | 0.360 |
| | 0.362 | 0.366 |
| | 0.364 | 0.381 |
| Reference Range: 4500~4745K | | |

| Bin | CIE X | CIE Y |
|-----------------------------|-------|-------|
| 45K-4 | 0.362 | 0.366 |
| | 0.359 | 0.352 |
| | 0.367 | 0.358 |
| | 0.370 | 0.373 |
| Reference Range: 4260~4500K | | |

| Bin | CIE X | CIE Y |
|-----------------------------|-------|-------|
| 45K-3 | 0.353 | 0.360 |
| | 0.351 | 0.347 |
| | 0.359 | 0.352 |
| | 0.362 | 0.366 |
| Reference Range: 4500~4745K | | |

Cool-White Bin Structure

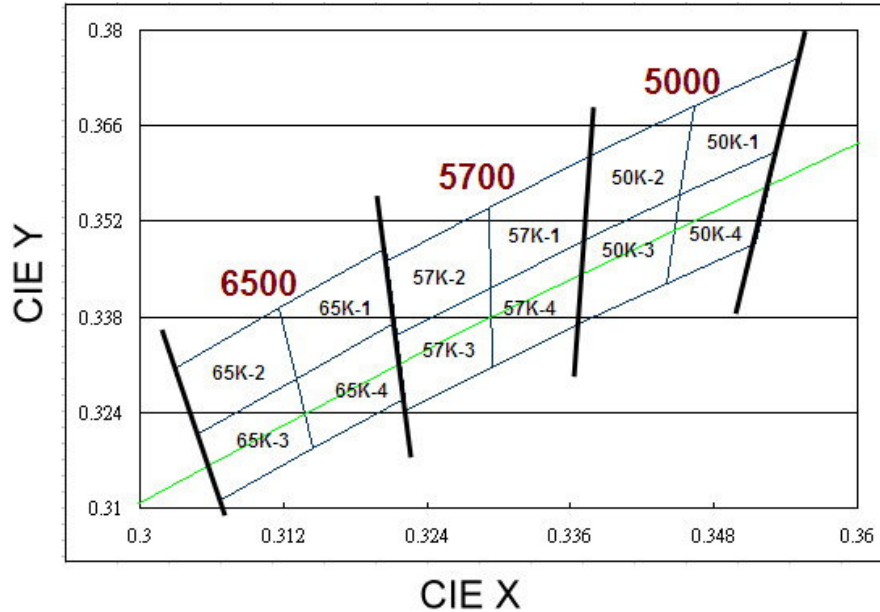

Cool-White Bin Coordinates

5000K

| Bin | CIE X | CIE Y |
|-----------------------------|-------|-------|
| 50K-1 | 0.346 | 0.369 |
| | 0.345 | 0.356 |
| | 0.353 | 0.362 |
| | 0.355 | 0.376 |
| Reference Range: 4745~5000K | | |

| Bin | CIE X | CIE Y |
|-----------------------------|-------|-------|
| 50K-2 | 0.338 | 0.362 |
| | 0.337 | 0.349 |
| | 0.345 | 0.356 |
| | 0.346 | 0.369 |
| Reference Range: 5000~5310K | | |

| Bin | CIE X | CIE Y |
|-----------------------------|-------|-------|
| 50K-4 | 0.345 | 0.356 |
| | 0.344 | 0.343 |
| | 0.352 | 0.349 |
| | 0.353 | 0.362 |
| Reference Range: 4745~5000K | | |

| Bin | CIE X | CIE Y |
|-----------------------------|-------|-------|
| 50K-3 | 0.337 | 0.349 |
| | 0.337 | 0.337 |
| | 0.344 | 0.343 |
| | 0.345 | 0.356 |
| Reference Range: 5000~5310K | | |

5700K

| Bin | CIE X | CIE Y |
|-----------------------------|-------|-------|
| 57K-1 | 0.329 | 0.354 |
| | 0.329 | 0.342 |
| | 0.337 | 0.349 |
| | 0.338 | 0.362 |
| Reference Range: 5310~5700K | | |

| Bin | CIE X | CIE Y |
|-----------------------------|-------|-------|
| 57K-2 | 0.321 | 0.346 |
| | 0.322 | 0.335 |
| | 0.329 | 0.342 |
| | 0.329 | 0.354 |
| Reference Range: 5700~6020K | | |

| Bin | CIE X | CIE Y |
|-----------------------------|-------|-------|
| 57K-4 | 0.329 | 0.342 |
| | 0.329 | 0.331 |
| | 0.337 | 0.337 |
| | 0.337 | 0.349 |
| Reference Range: 5310~5700K | | |

| Bin | CIE X | CIE Y |
|-----------------------------|-------|-------|
| 57K-3 | 0.322 | 0.335 |
| | 0.322 | 0.324 |
| | 0.329 | 0.331 |
| | 0.329 | 0.342 |
| Reference Range: 5700~6020K | | |

6500K

| Bin | CIE X | CIE Y |
|-----------------------------|-------|-------|
| 65K-1 | 0.312 | 0.339 |
| | 0.313 | 0.329 |
| | 0.321 | 0.337 |
| | 0.321 | 0.348 |
| Reference Range: 6020~6500K | | |

| Bin | CIE X | CIE Y |
|-----------------------------|-------|-------|
| 65K-2 | 0.303 | 0.330 |
| | 0.305 | 0.321 |
| | 0.313 | 0.329 |
| | 0.312 | 0.339 |
| Reference Range: 6500~7050K | | |

| Bin | CIE X | CIE Y |
|-----------------------------|-------|-------|
| 65K-4 | 0.313 | 0.329 |
| | 0.315 | 0.319 |
| | 0.322 | 0.326 |
| | 0.321 | 0.337 |
| Reference Range: 6020~6500K | | |

| Bin | CIE X | CIE Y |
|-----------------------------|-------|-------|
| 65K-3 | 0.305 | 0.321 |
| | 0.307 | 0.311 |
| | 0.315 | 0.319 |
| | 0.313 | 0.329 |
| Reference Range: 6500~7050K | | |

Notes:

1. Color coordinates measurement allowance : ± 0.01 .

Forward Voltage Bins

| Bin | Minimum Forward Voltage (V) | Maximum Forward Voltage (V) |
|-----|-----------------------------|-----------------------------|
| W1 | 27 | 29 |
| W2 | 29 | 31 |
| W3 | 31 | 33 |

Notes:

1. Forward voltage measurement tolerance: $\pm 2\%$.
2. Forward voltage bins are defined at $I_f=500\text{mA}$ operation.
3. Other Forward Voltage bins for White LEDs available upon request. Please contact your local Everlight sales office.

Mechanical Dimension

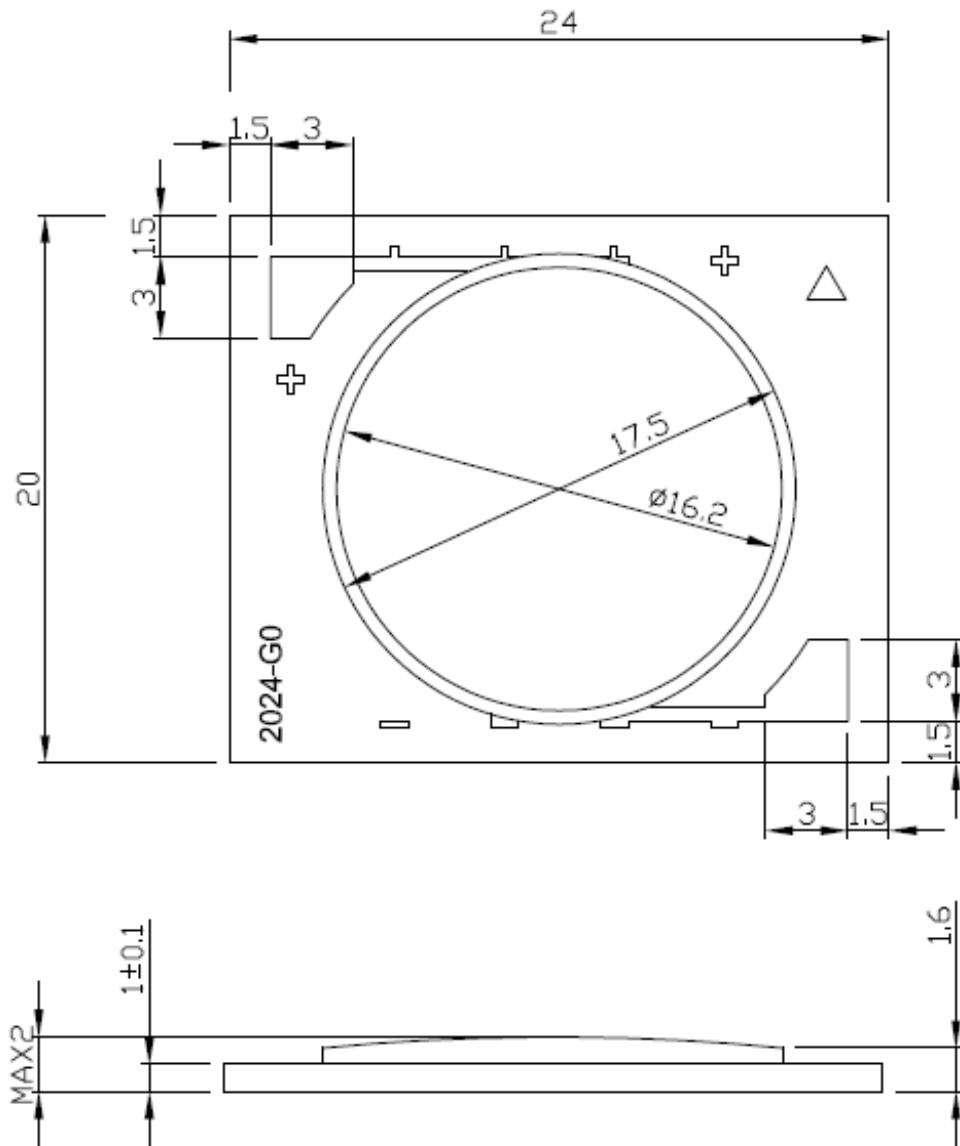

Chip Configuration

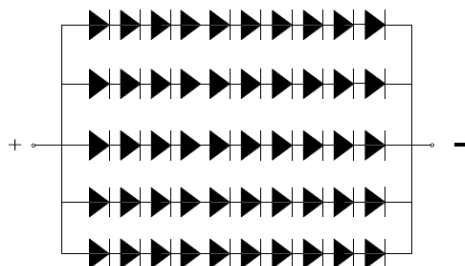

10series \times 5parallel = 50 pcs of LEDs

Note:

1. Dimensions are in millimeters.
2. Tolerances unless mentioned are ± 0.25 mm.

Pad Configuration

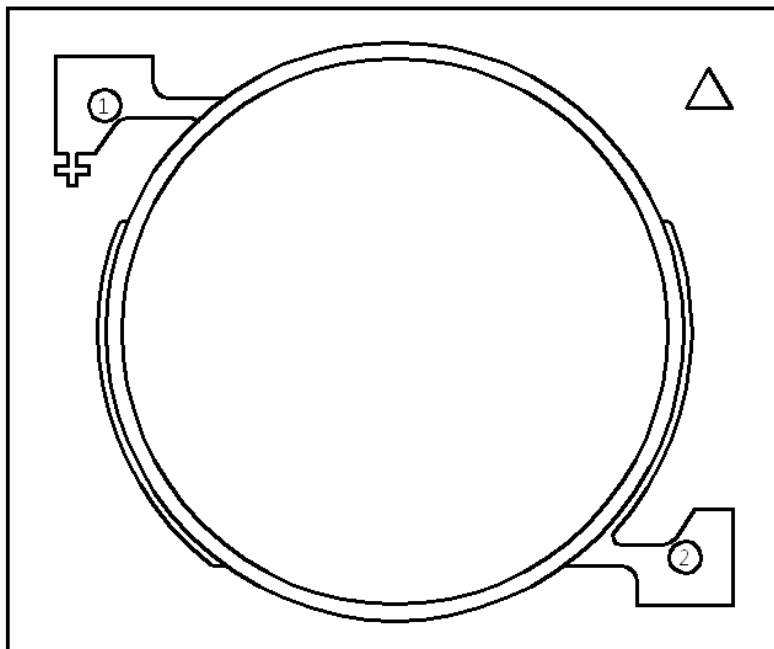

| PAD | FUNCTION |
|-----|----------|
| 1 | ANODE |
| 2 | CATHODE |

15W COB Series Typical Electro-Optical Characteristic Curve

Relative Spectral Distribution
@ Substrate Temperature = 25°C

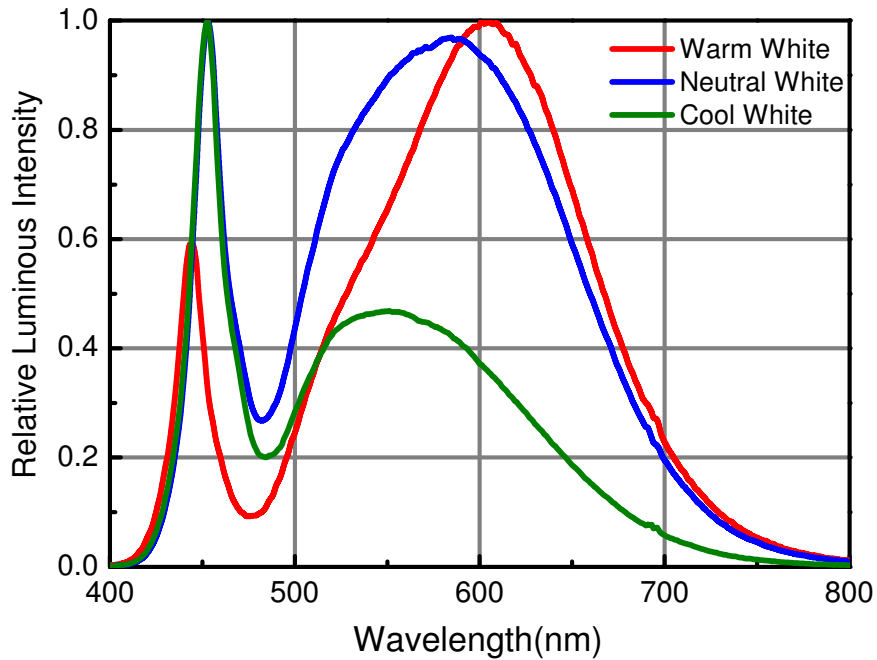

Relative Luminous Flux vs. Substrate Temperature
@Forward Current = 500mA

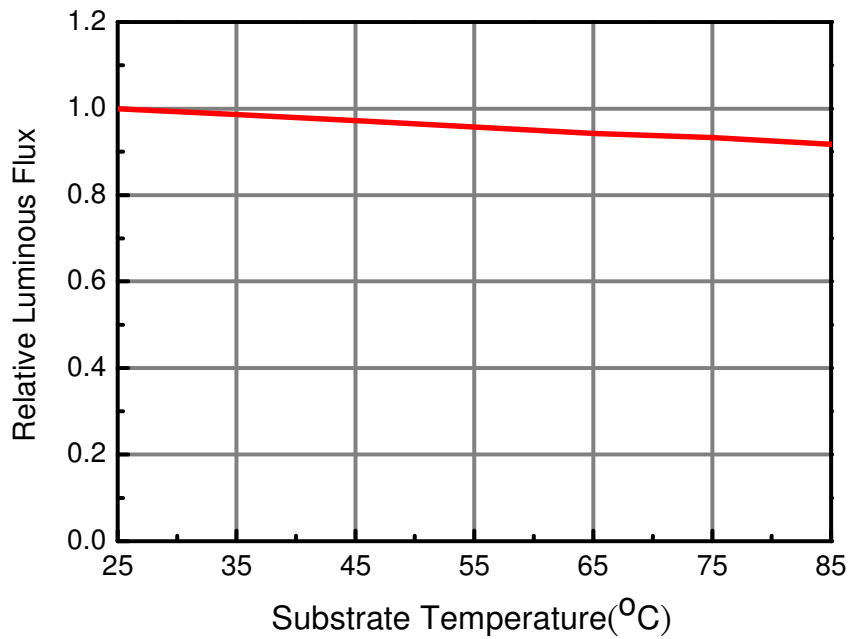

Forward Voltage vs. Forward Current
@ Substrate Temperature = 25°C

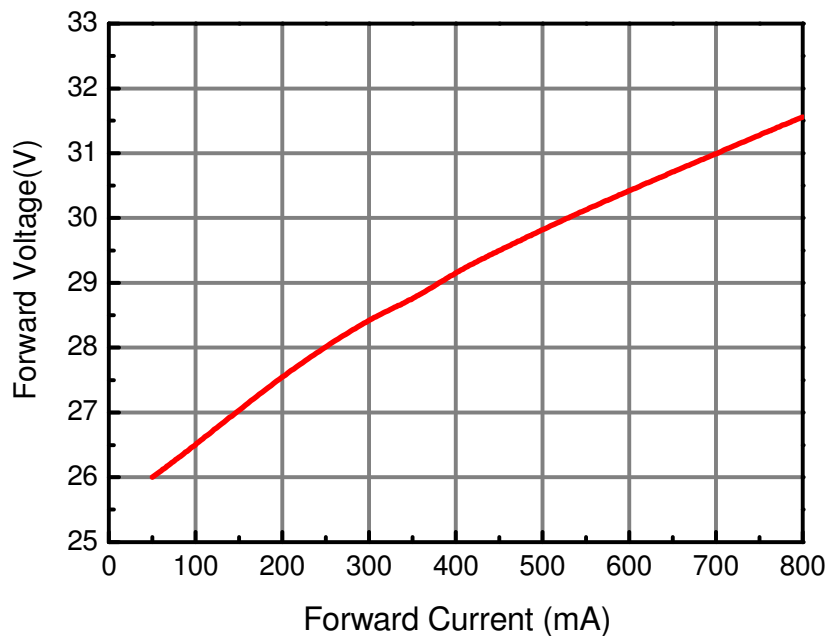

Relative Luminous Flux vs. Forward Current
@ Substrate Temperature = 25°C

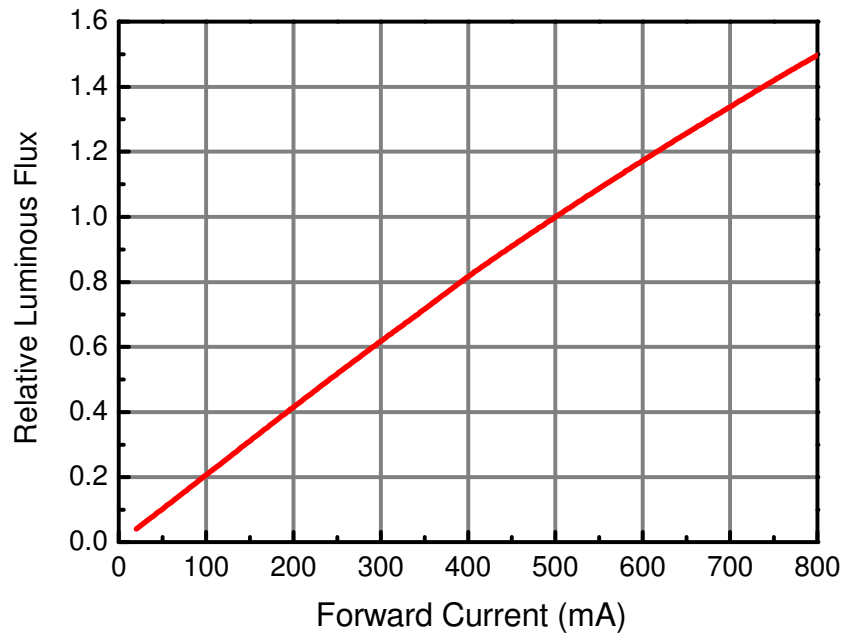

Correlated Color Temperature vs. Forward Current
@ Substrate Temperature = 25°C

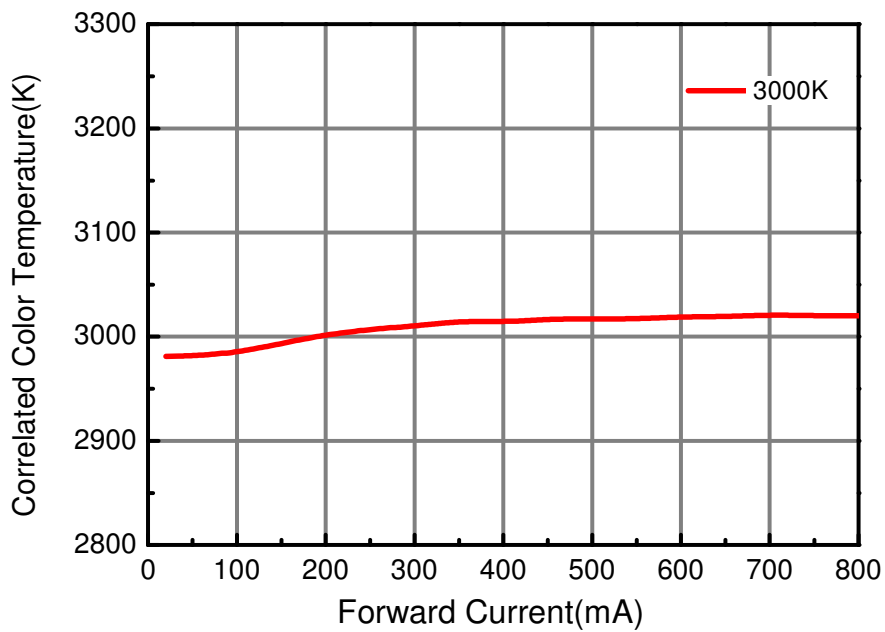

Correlated Color Temperature vs. Substrate Temperature

@ Forward Current = 500mA

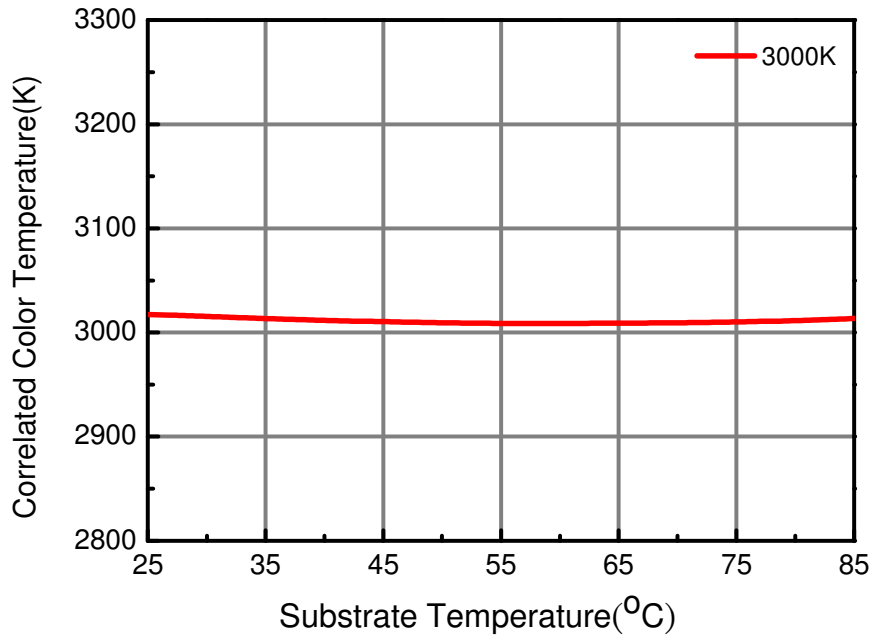

Forward Voltage vs. Substrate Temperature
@ Forward Current = 500mA

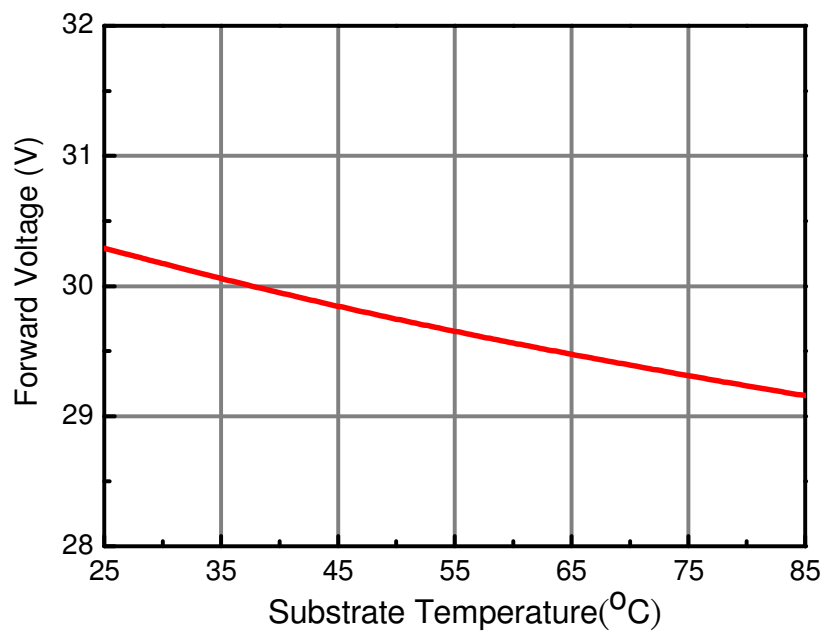

Forward Current Derating Curve @ Junction Temperature <115°C

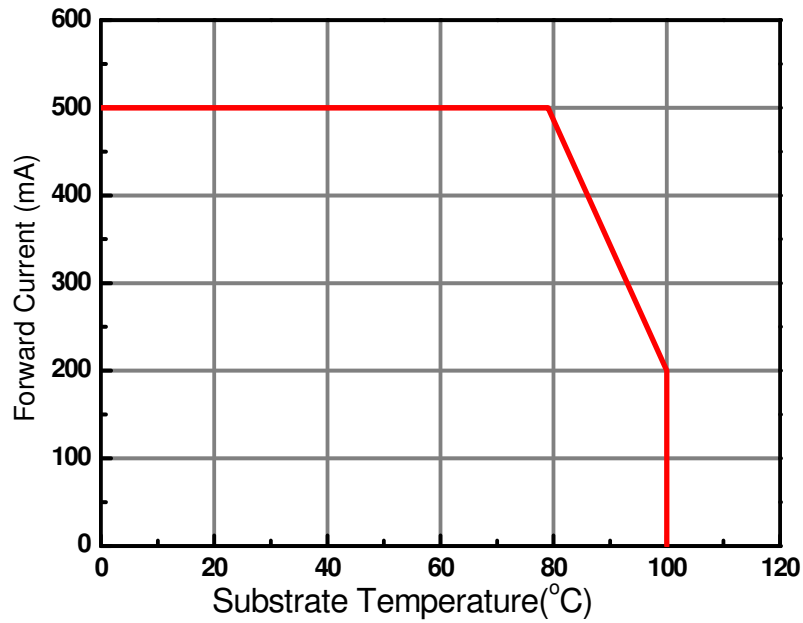

Typical Diagram Characteristics of Radiation Patterns

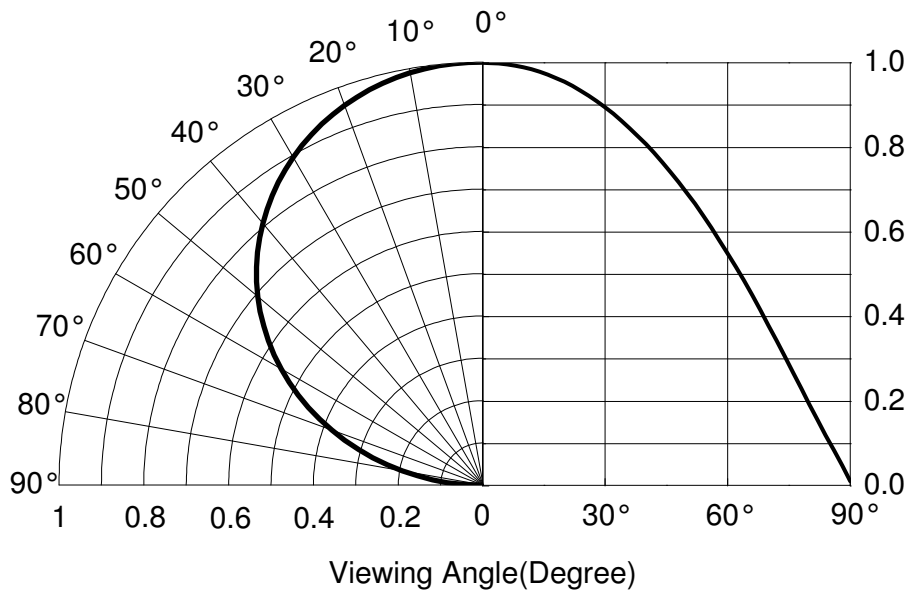

Notes:

1. 2θ_{1/2} is the off axis angle from lamp centerline where the luminous intensity is 1/2 of the peak value.
2. Viewing angle tolerance is ± 5° .

Product Labeling

Label Explanation

CPN: Customer Specification (when required)

P/N : Everlight Production Number

QTY: Packing Quantity

CAT: Luminous Flux (Brightness) Bin

HUE: Color Bin

REF: Forward Voltage Bin

LOT No: Lot Number

MADE IN TAIWAN: Production Place

Carrier Tray Specification

Loaded Quantity:48 PCS Per Tray

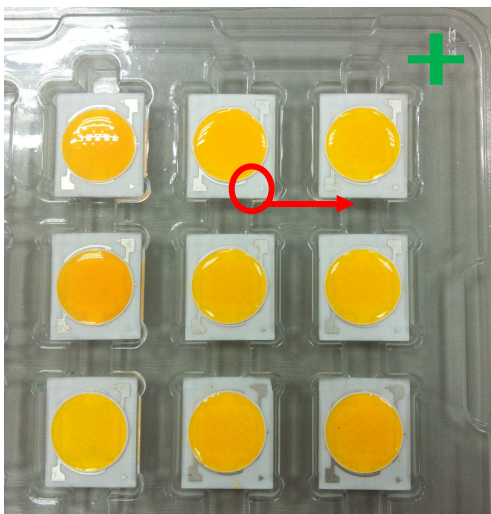

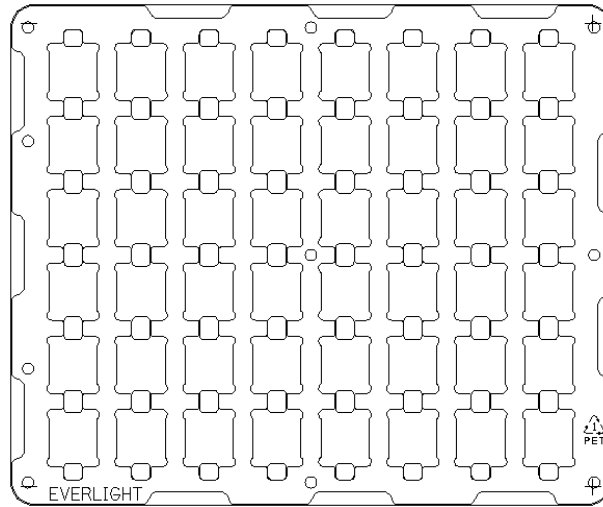

LED Direction

- The **triangle mark** on the LEDs will be toward the **Anode mark** on the carrier tray.

Moisture Resistant Packaging



Outside Carton

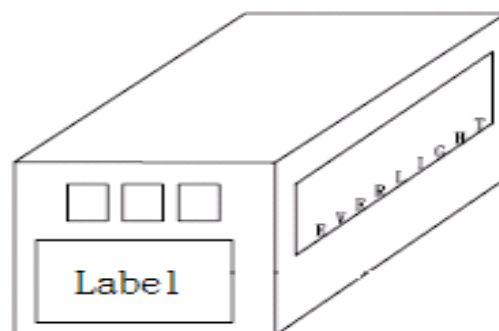

Packaging Quantity

- 48 PCS Per Tray
- 10 Trays Per Outside Carton

Precautions of Use

Over-Current-Proof

- Though the EAHP2024WB8 has a conducted ESD protection mechanism, customers must not use the device in reverse and should apply resistors for extra protection. Otherwise slight voltage shift may cause significant current changes and burn out failure may happen.

Storage

- Before the package is opened. The LEDs should be stored at 30°C or less and 50%RH or less after being shipped from Everlight and the storage life limits are 6 months. If the LEDs are stored for 6 months or more, they should be stored in a sealed container with a nitrogen atmosphere and moisture absorbent material.
- After opening the package: The LED's should be stored under 30°C or less and 60%RH or less. The LED should be used within 168hrs (7days) after opening the package. If unused LEDs remain, it should be stored in moisture proof packages.
- Do not stack assemblies..



Handling

- Do not put mechanical stress on the LED.
- Never touch the optical surface with a finger or sharp object. The LED surface could be soiled or damaged, which could affect the optical performance of the LED.
- In a low-humidity work environment, please keep handling the LEDs with appropriate ESD grounding.
- It is recommended to handle the LED with powder-less latex gloves.

Manual Handling

When handling the product, do not apply direct pressure on the optical surface.

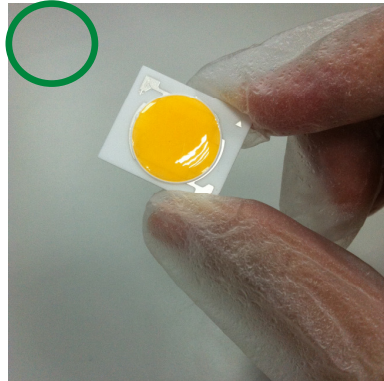

Do not touch the resin with tweezers to avoid scratching or other damage.

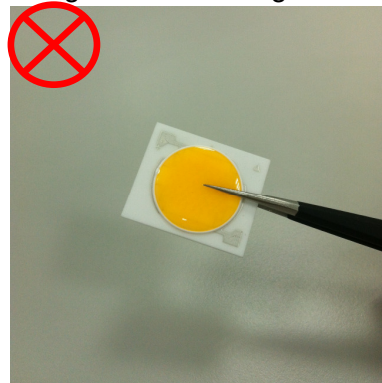
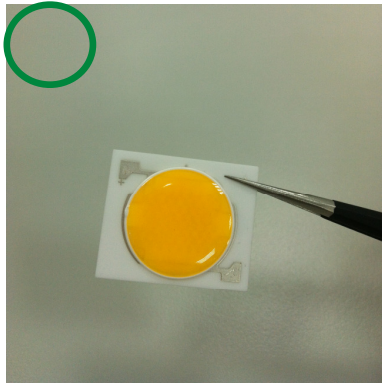

Thermal Management

- Sufficient thermal management must be implemented. The substrate temperature must be kept under 85°C at the driving current 500mA. Otherwise, the junction temperature of die may exceed over the limit at high current driving conditions and the LEDs' lifetime may be decrease dramatically.

Revision History

Current version: **15.Jul.2014**

Issue No: DHE-000XXXX

Version: 1

| Page | Subjects (major change in previous version) | Date of change |
|------|---|----------------|
| | | |
| | | |
| | | |
| | | |
| | | |